

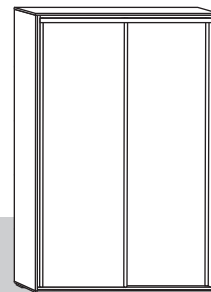

www.MLMEBLE.pl



GB D CZ SK RUS LT
assembly instructions / montageanleitung / montážní návod / montážny návod / инструкции по монтажу / surinkimo instrukcija



INSTRUKCJA MONTAŻU

BONTI 02

↑190 →110 ↗67

akcesoria / accessories / zubehör / příslušenství / prislušenstvo / аксесуары / furnitūra :



x 26 KK 8/32	x 9 KT 6,3/50	x 2 KT 6,4/70	x 8 ZA N	x 100 GZ 1,4/25	x 16 MD	x 4 UB 0	x 12 PA Ø5	x 8 WT 3,5x16	x 9 WTLP 3x16	x 15 WT 4x30	
x 15 WT 4x35	x 18 BDP	x 2 drażek / stick / stock / hůl / palica / трость / strypas	x 1 TG	x 1 TD	x 1 ZAT	x 4 WZD	x 4 WZG	x 8 WT 4x23	x 2 SZT L-1970	x 2 SR HI-TEC	
x 5 ST BI-150	x 1 klej / glue / kleber / lepidlo / lepido / клей / klijai	x 1 kluczyk / key / schlüssel / klíč / ključ / ключ / raktas									

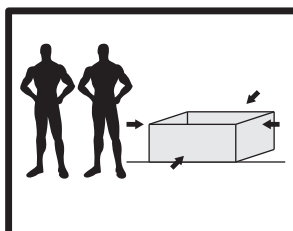
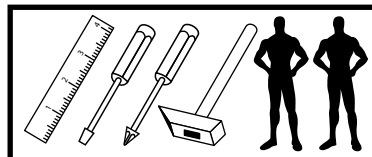

do montażu potrzebne są:
are needed for assembly:
sind erforderlich für die montage:
jsou potřebné pro montáž:
sú potrebné pre montáž:
которые необходимы для сборки:
Surinkimui reikės:



UWAGA ! - mebel należy składać w pozycji poziomej
WARNING! - furniture should be submitted in a horizontal position
WARNUNG! - Möbel sollten in einer horizontalen Position vorzulegen
POZOR! - Nábytek by měl být předložen ve vodorovné poloze
POZOR! - Nábytok by mal byť predložený vo vodorovnej polohe
ВНИМАНИЕ! - Мебель должна быть представлена в горизонтальном положении
DĚMESIO! - Baldą surenkame horizontalioje padėtyje

UWAGA ! - w pierwszej kolejności wbijamy akcesoria „KK” i „MD” w białe oraz boki.
WARNING! - The first accessory sticks "KK" and "MD" in the tops and sides.
WARNUNG! - Die erste Accessoire-Sticks "KK" und "MD" in den Spitzen und an den Seiten.
POZOR! - První příslušenství holi "KK" a "MD" v korunách a boky.
POZOR! - Prvé príslušenstvo palíc "KK" a "MD" v korunách a boky.
ВНИМАНИЕ! - Первый аксессуаров палочки "KK" и "MD" по вершинам и по бокам.
DĚMESIO! - Pirmiausiai furnitūrą KK ir MD įkalame į stalviršį ir šonus.

	CODE			
1	BONTI02_01	2047	655	1
2	BONTI02_02	2047	655	1
3	BONTI02_03	1100	656	1
4	BONTI02_04	1100	656	1
5	BONTI02_05	1703	507	1
6	BONTI02_06	1064	507	1
7	BONTI02_07	453	506	1
8	BONTI02_08	453	506	3
9	BONTI02_09	595	124	1
10	BONTI02_10	518	1962	2
11	BONTI02HDF_01	1723	475	1
12	BONTI02HDF_02	1723	616	1
13	BONTI02HDF_03	1091	346	1
14	BONTI02W_01	1064	80	1
15	BONTI02W_02	1014	80	1

	CODE			
16	BONTI02W_03	2021,5	80	1
17	BONTI02W_04	2021,5	80	1

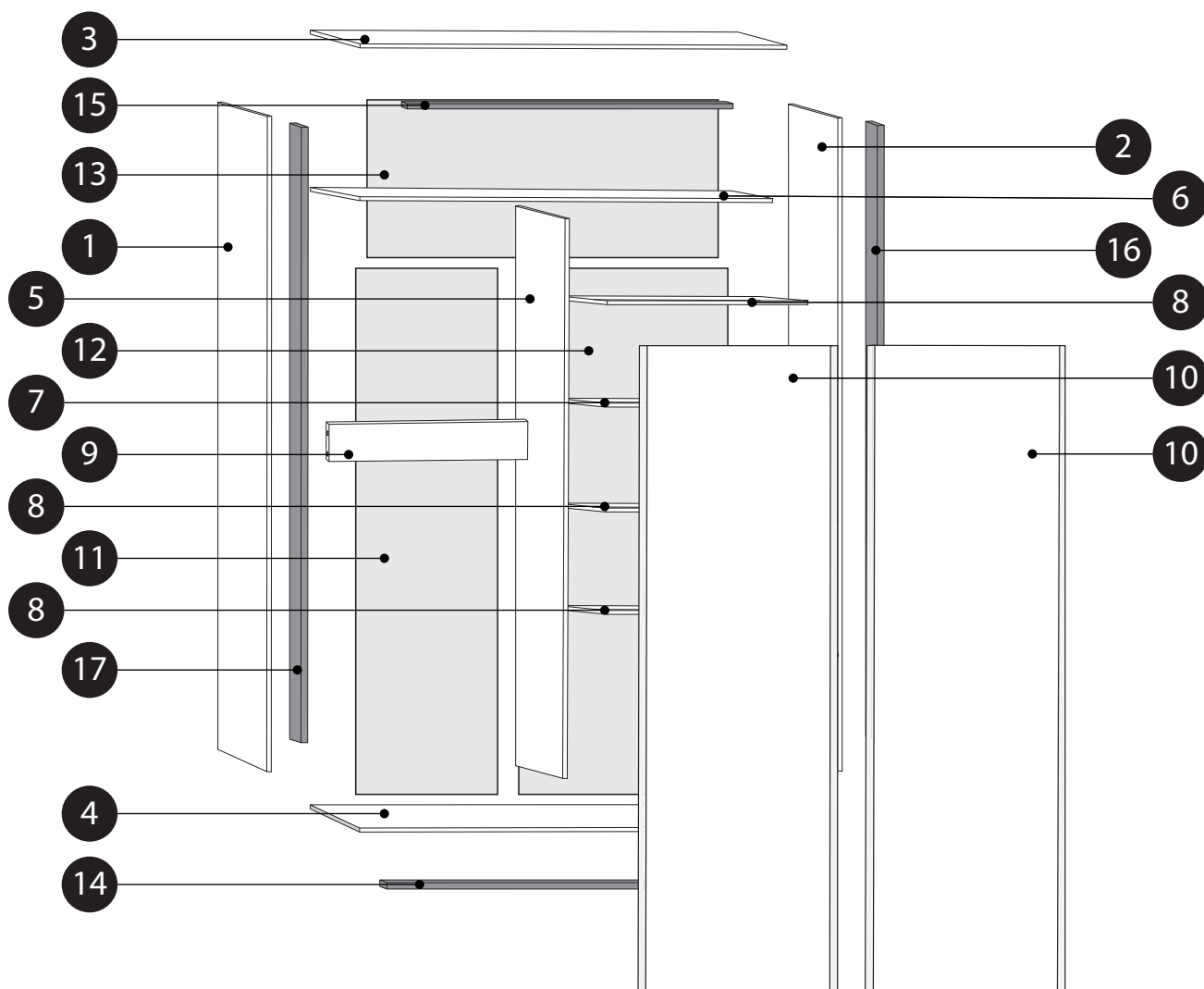
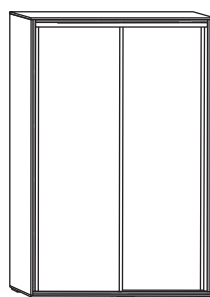

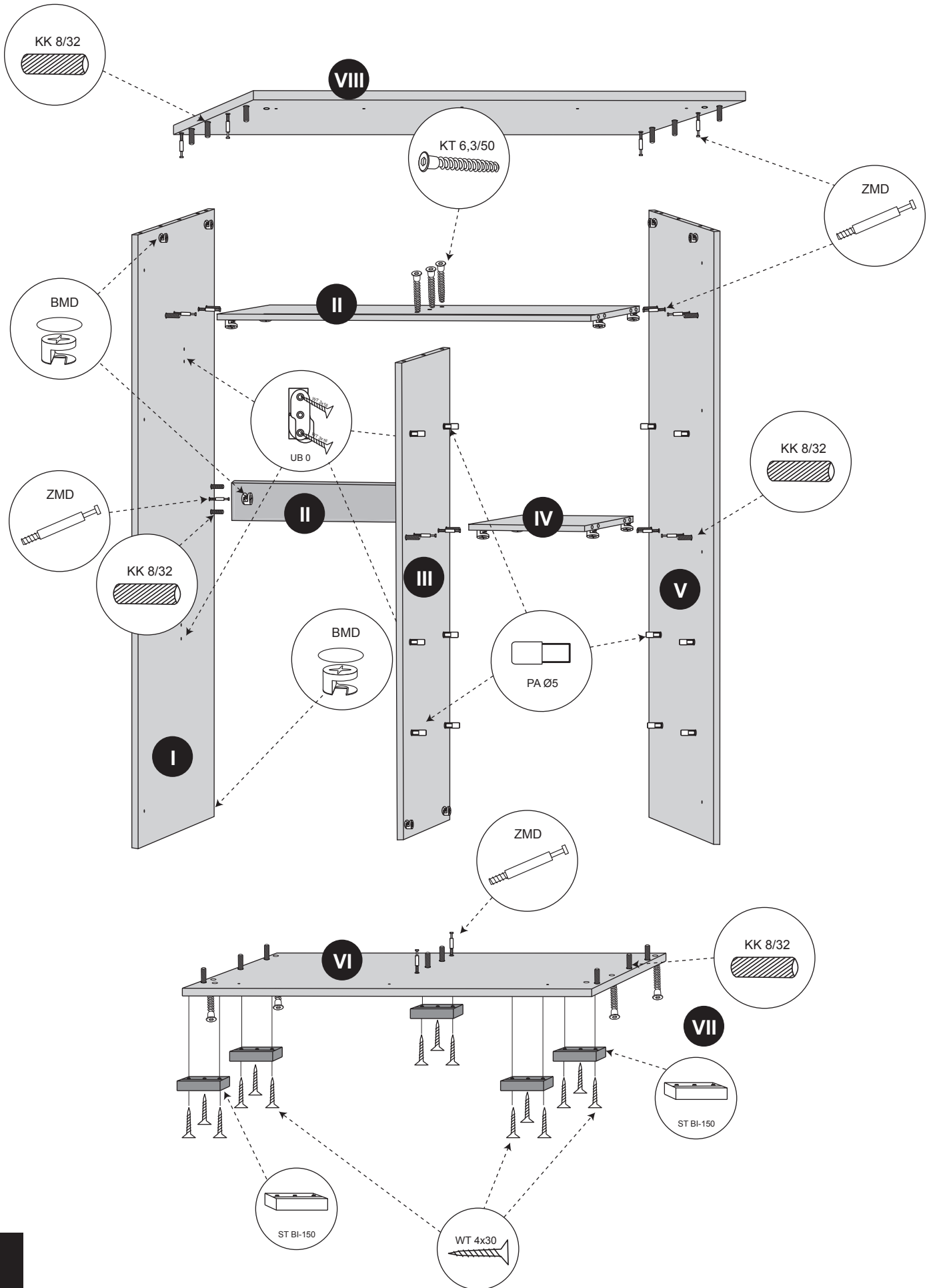

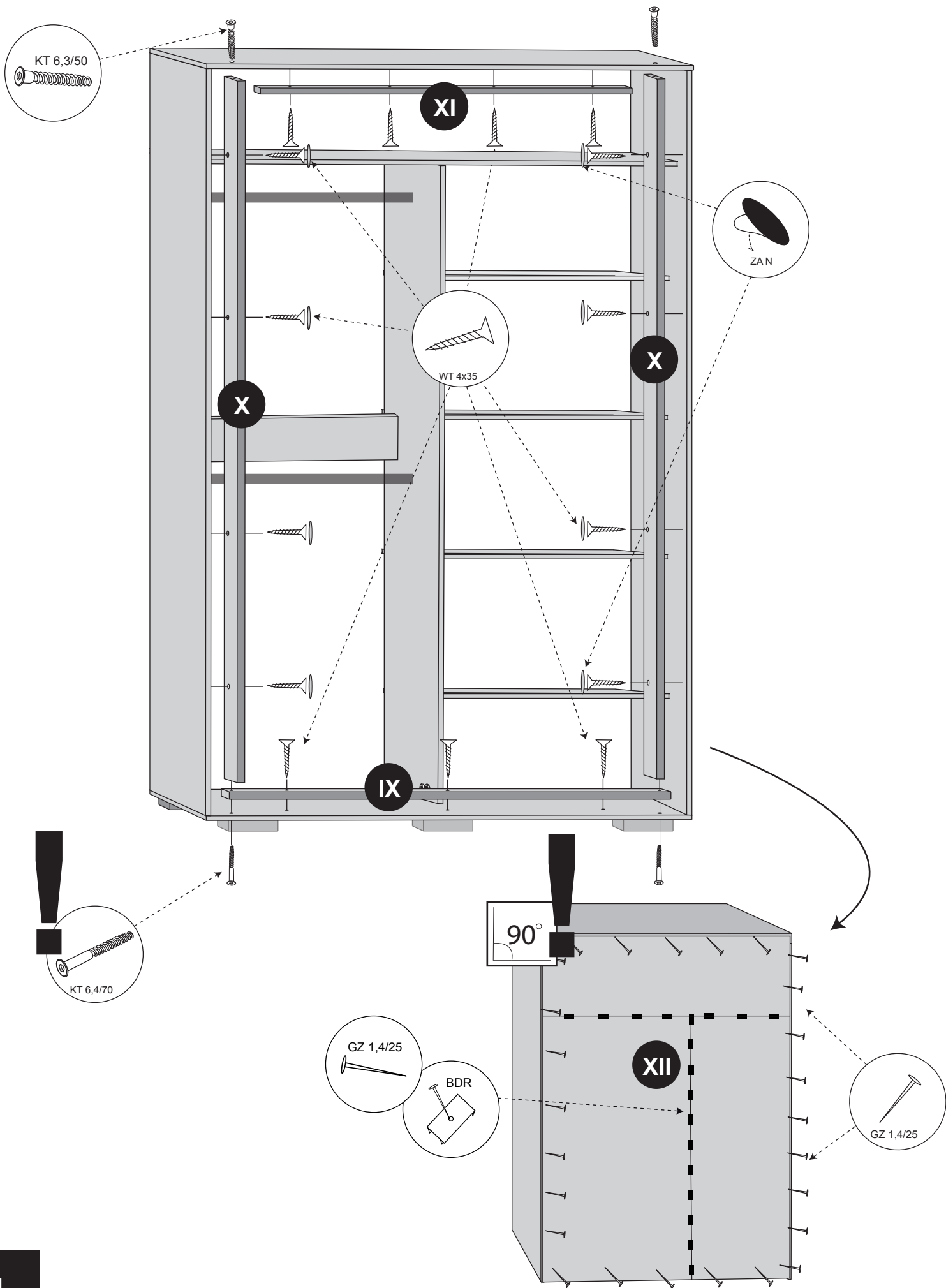

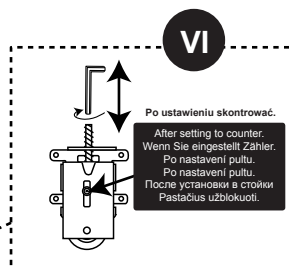
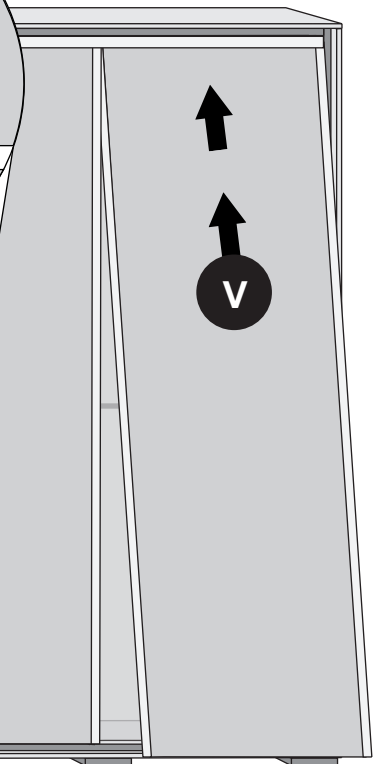
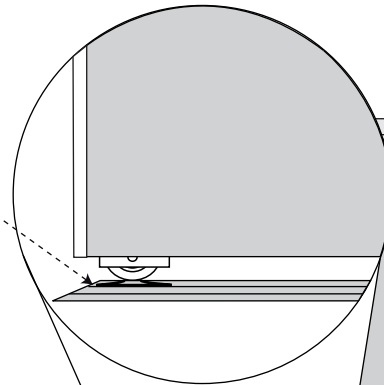
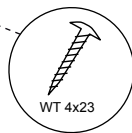
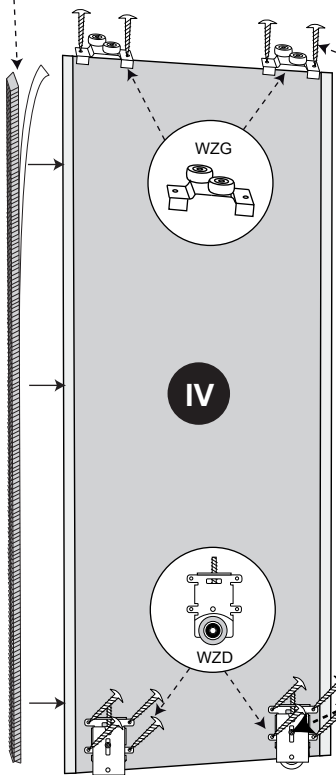
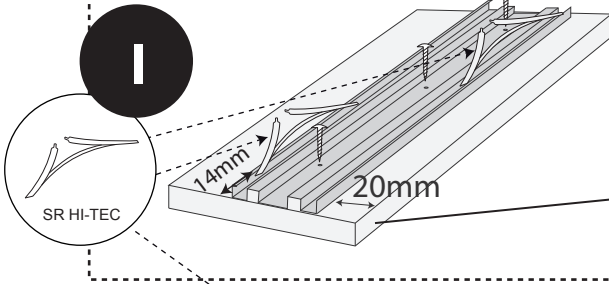
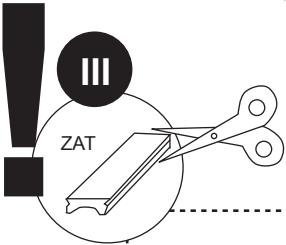
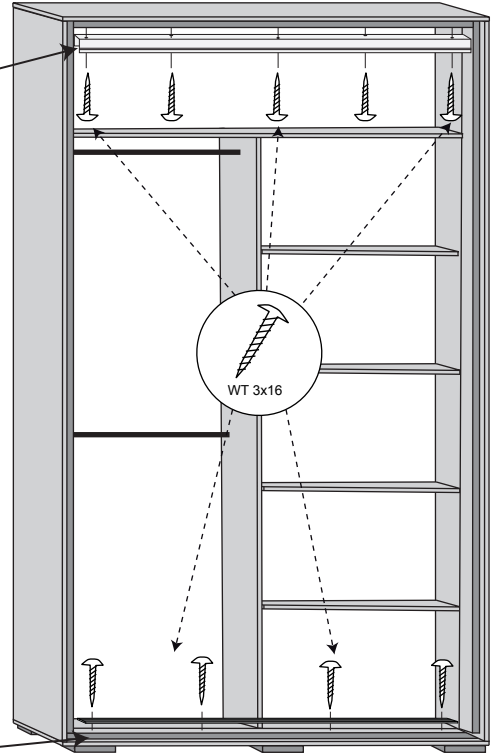
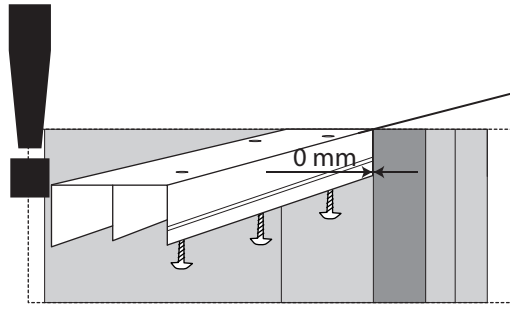
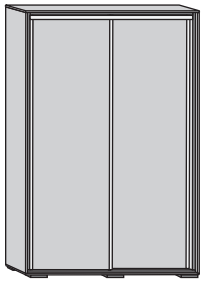

Po ustawieniu skontrolować.
 After setting to counter.
 Wenn Sie eingestellt Zähler.
 Po nastawieni pultu.
 После установовки в стойки
 Ростаčius užblokuoti.