



www.MLMEBLE.pl

GB D CZ SK RUS LT  
assembly instructions / montageanleitung / montážní návod / montážny návod / инструкции по монтажу / surinkimo instrukcija



## INSTRUKCJA MONTAŻU

**FJORD 14**  
 76 120 56

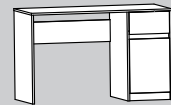

akcesoria / accessories / zubehör / příslušenství / príslušenstvo / аксессуары / furnitūra :

x 24  KK 8/32	x 2  KT 6,3/50	x 10  GZ 1,4/25	x 6  SG 8/8	x 16  MD	x 6  ZAM	x 4  PA Ø5	x 4  WT 3,5x16	x 4  WE 6,3x13	x 14  WTLP 3x16	x 4  SP
x 1  PK L-350	x 6  WE 6,3x13 ES	x 2  ZPW	x 2  PK H-4	x 1  klej / glue / kleber / lepidlo / lepidlo / клеи / klijai	x 1  kluczyk / key / schlüssel / klíč / ключ / raktas					

do montażu potrzebne są:  
 are needed for assembly:  
 sind erforderlich für die montage:  
 jsou potřebné pro montáž:  
 sú potrebné pre montáž:  
 которые необходимы для сборки:  
 Surinkimui reikės:

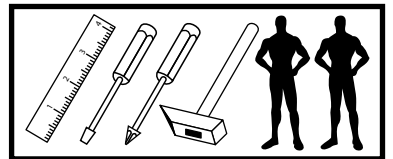

**UWAGA !** - w pierwszej kolejności wbijamy akcesoria „KK” i „MD” w blaty oraz boki.  
**WARNING!** - The first accessory sticks "KK" and "MD" in the tops and sides.  
**WARNUNG!** - Die erste Accessoire-Sticks "KK" und "MD" in den Spitzen und an den Seiten.  
**POZOR!** - První příslušenství holí "KK" a "MD" v korunách a boky.  
**POZOR!** - Prvé príslušenstvo palíc "KK" a "MD" v korunách a boky.  
**ВНИМАНИЕ!** - Первый аксессуаров палочки "KK" и "MD" по вершинам и по бокам.  
**DÉMESIO!** - Pirmiausiai furnitūrą KK ir MD įkalame į stalviršį ir šonus.

Nr/No	Szt/Qty
1	1
2	1
3	1
4	1
5	1
6	1
7	1
8	1
9	1
10	1
11	1
12	1
13	1
14	1
15	1
16	1

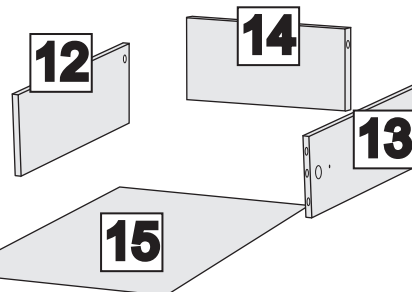
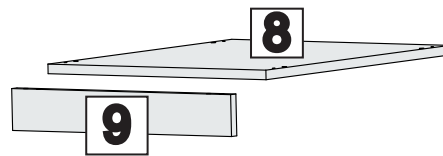
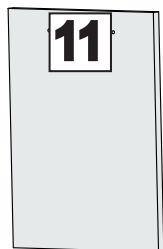
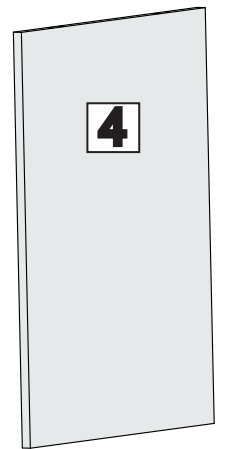
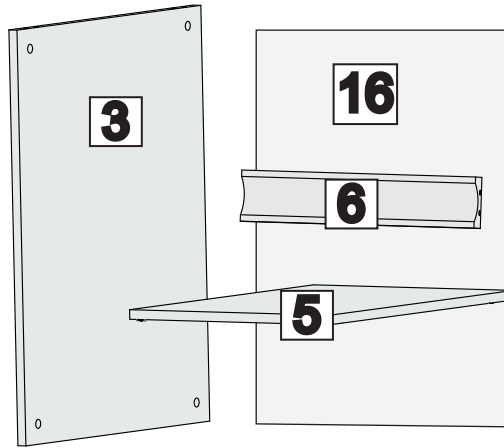
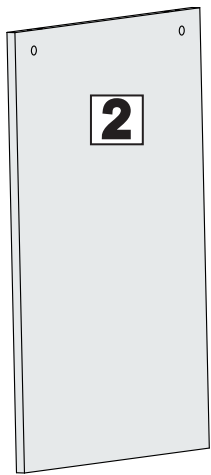

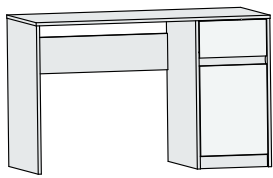

**! UWAGA !** - Wypinanie prowadnicy  
**WARNING!** - guides disassembling  
**WARNING!** - Ausstecken Führer  
**POZOR!** - vytažení pojezdů  
**POZOR!** - sprievodca pre montáž nábytku  
**ВНИМАНИЕ!** - демонтаж направляющих  
**DĒMESIO!** - Išrinkimas atskyrimas

