

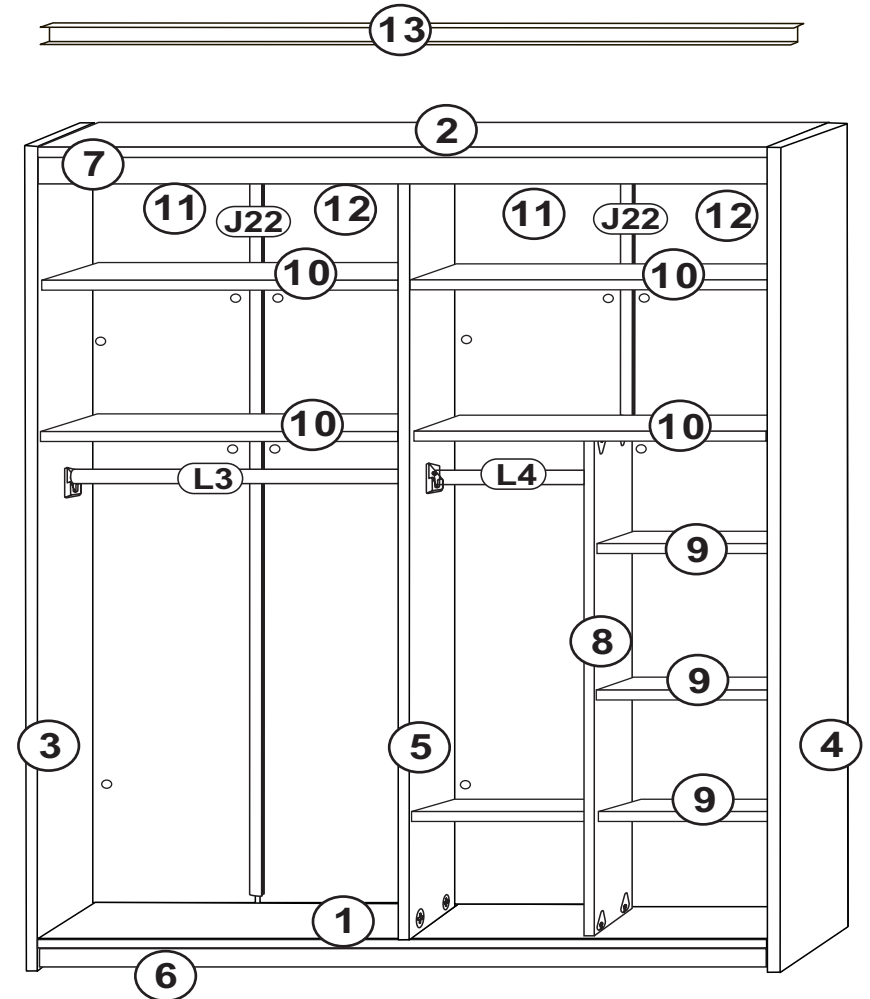

PAULA

P8--PA 72

1 / 10

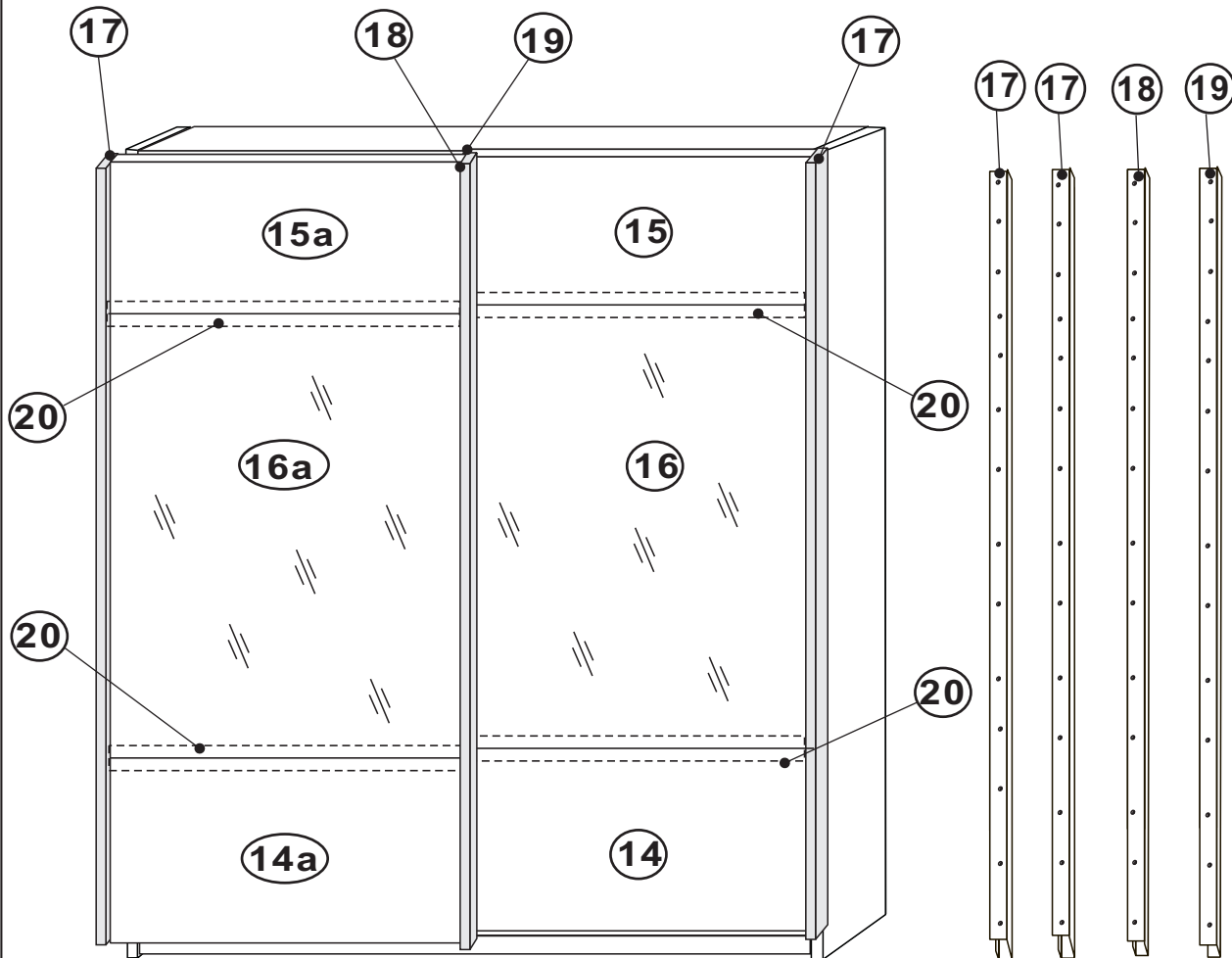
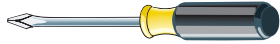
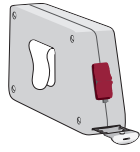
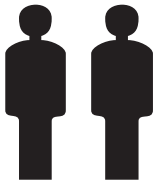



**1**

**T6**  x20

**C2**  x12

**M1**  x12

**T1**  x12

**B1**   $\phi$  8x28mm x14

**K1**   $\phi$  7x50mm x3

**C1**   $\phi$  2 x2

**W3**  x16

**M6**  x16

**P16**   $\phi$  4,2x13mm x16

**L1**  x1

**2**

**F7**  x4

**S2**   $\phi$  3,0x13mm x4

**3**

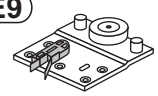
**E9**  x1

**E1**   $\phi$  6,3x11mm x5

**E11**  x1

**4**

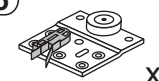
**E5**  x2

**E1**   $\phi$  6,3x11mm x10

**5**

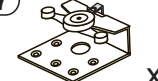
**E7**  x3

**E1**   $\phi$  6,3x11mm x15

**6**

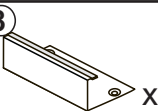
**E8**  x2

**E1**   $\phi$  6,3x11mm x4

**7**

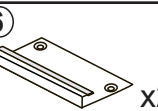
**E6**  x2

**E1**   $\phi$  6,3x11mm x4

**8**

**L4**  x2

**S3**   $\phi$  3,5x13mm x81

**S2**   $\phi$  3,0x13mm x56

**L5**  L=2374 mm x3

**L1**  x1

**9**

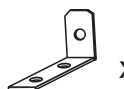
**J11**  x2

**P13**   $\phi$  3,5x13 mm x4

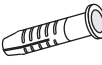
**T13**   $\phi$  8x40 x2

**S15**  x2

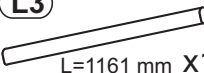
**L3**  L=1161 mm x1

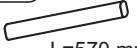
**L4**  L=570 mm x1

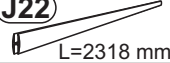
**J22**  L=2318 mm x2

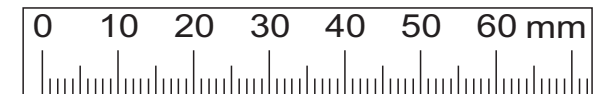

1

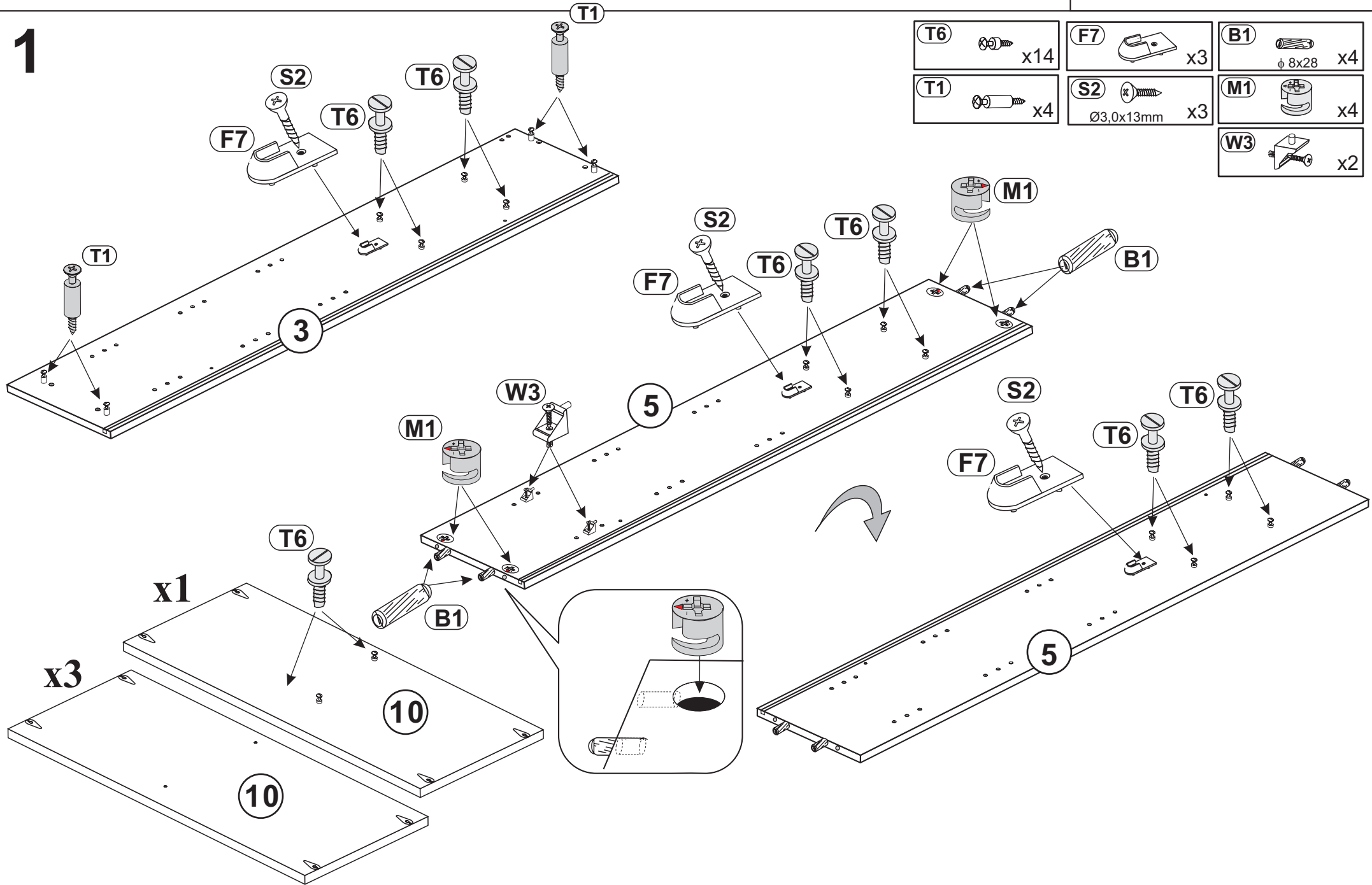

2

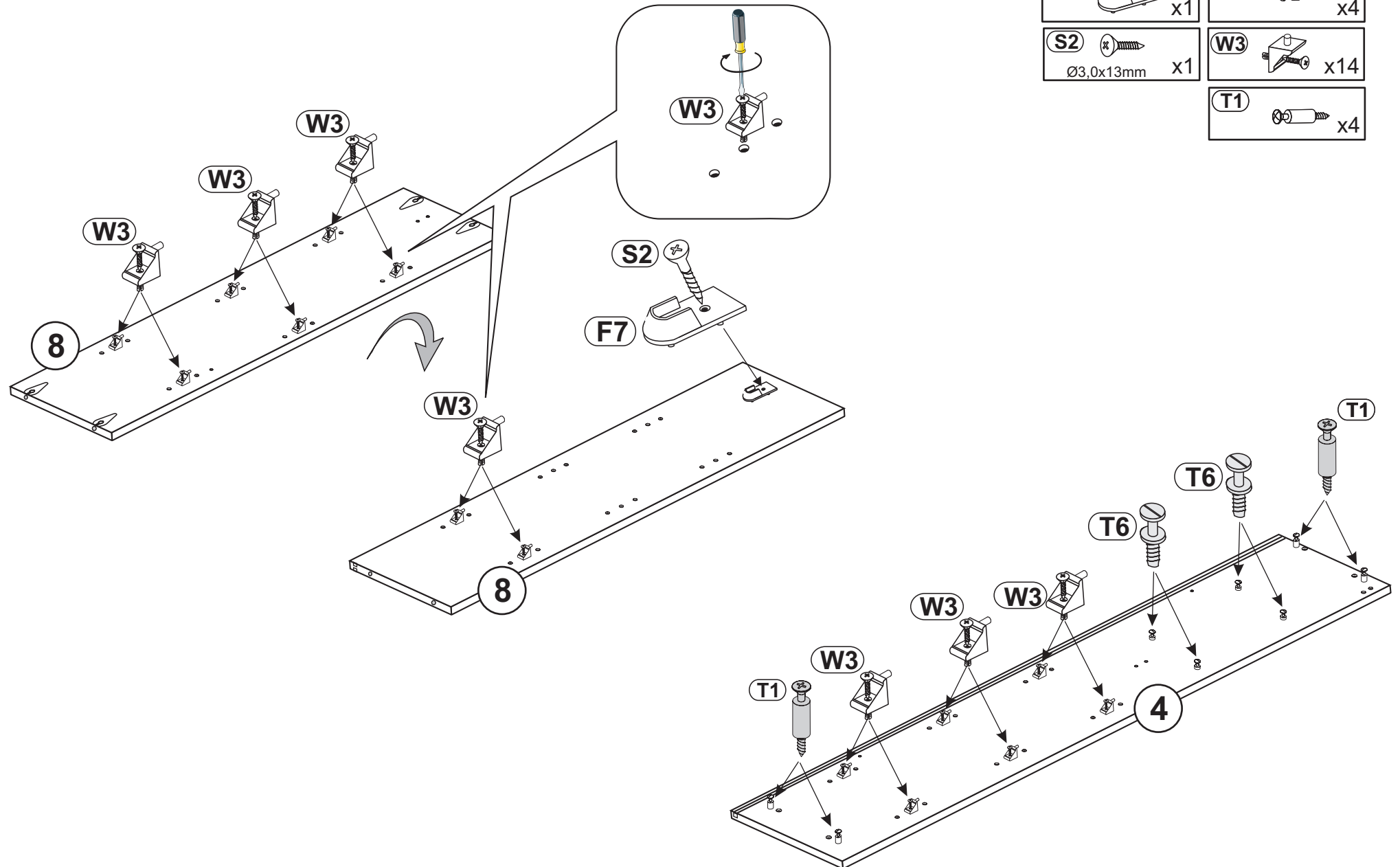

3

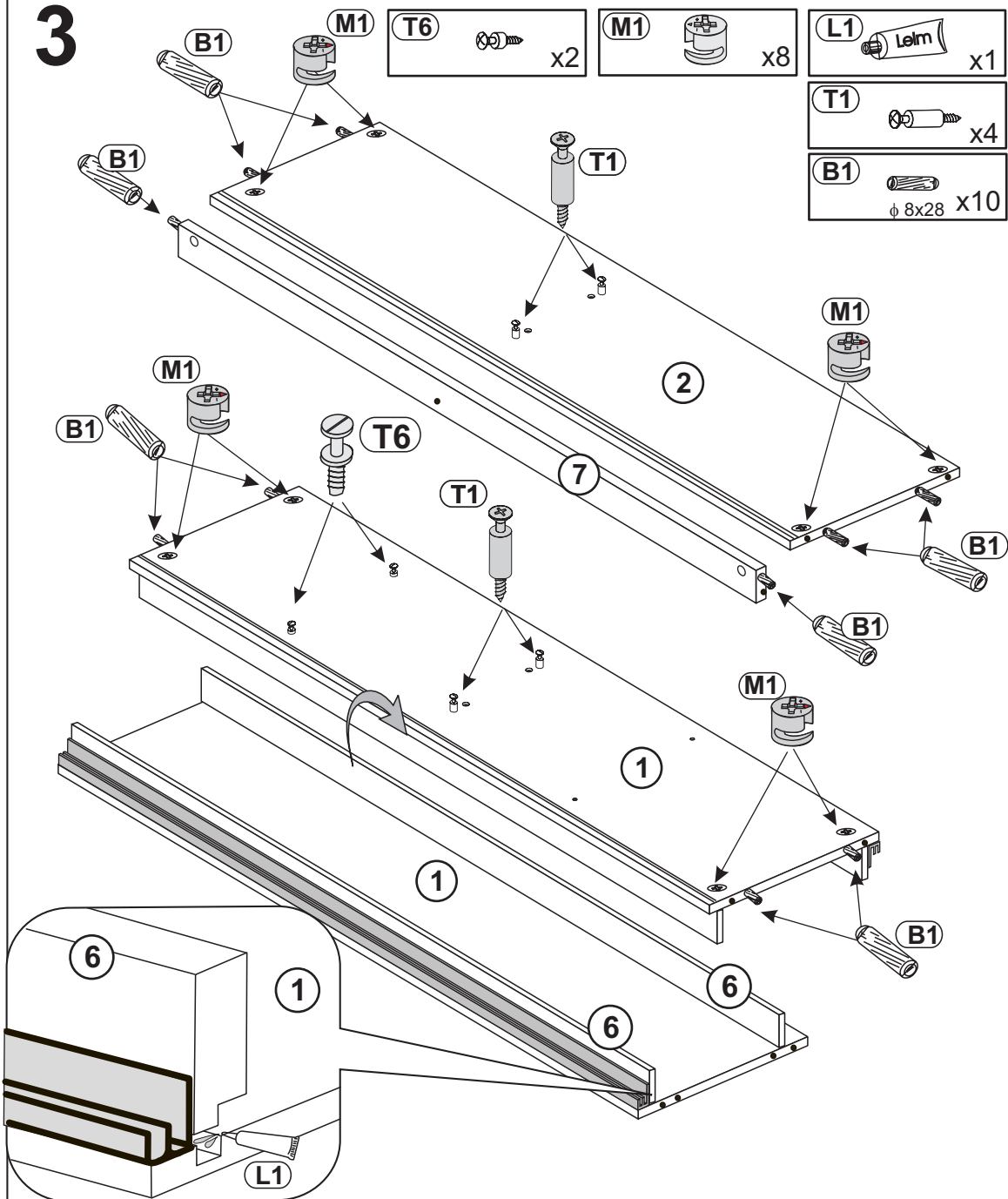

4

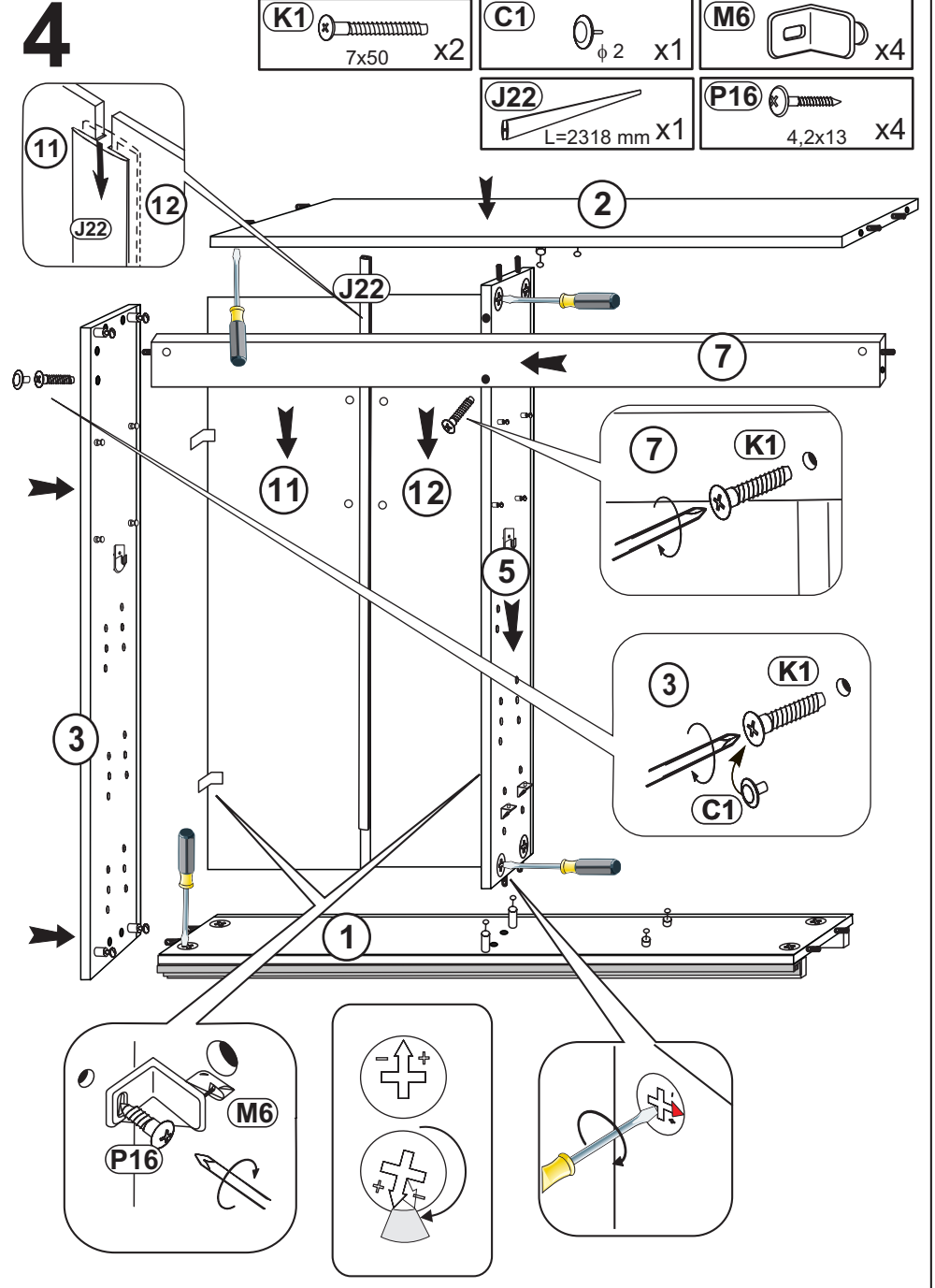

5

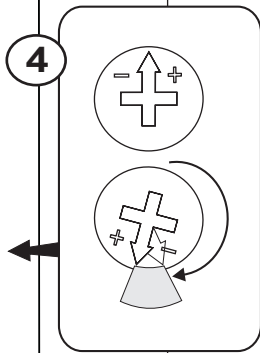
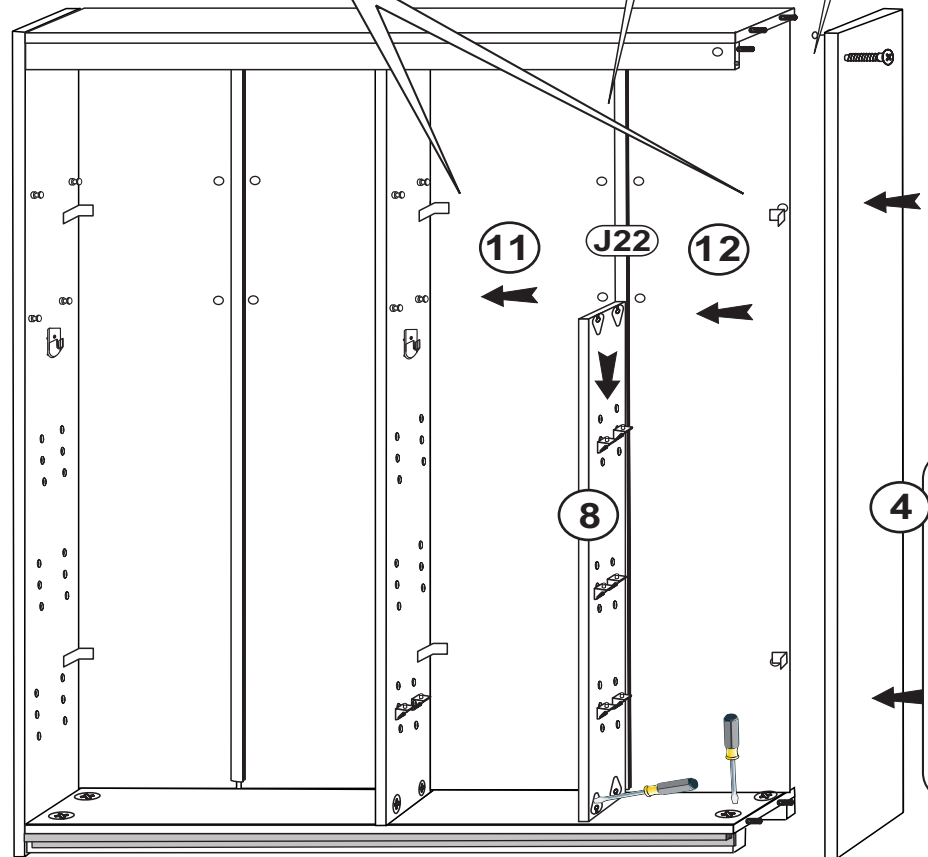
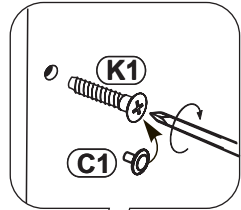
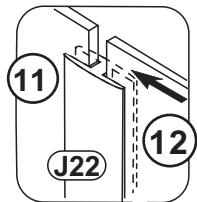
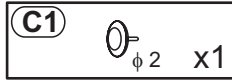
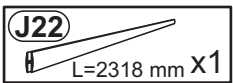
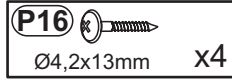
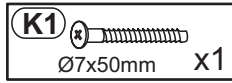

6

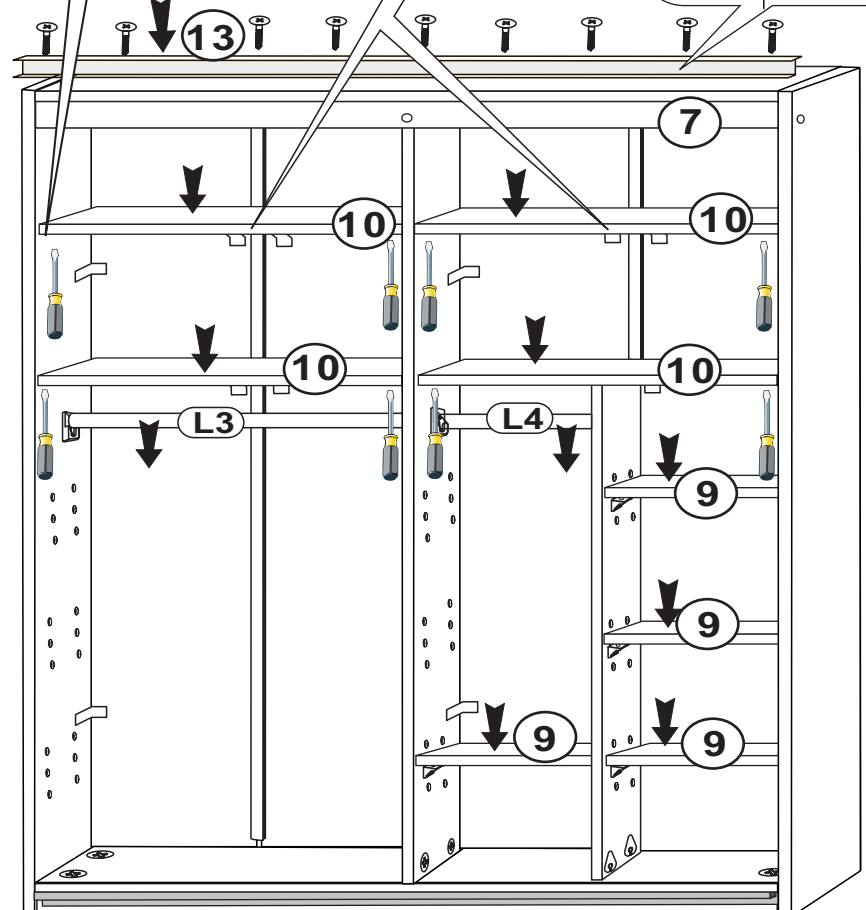
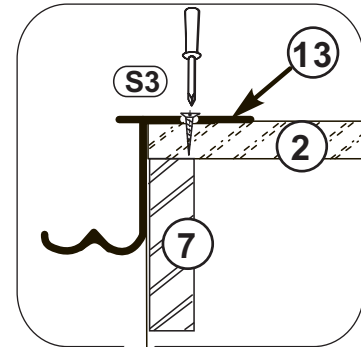
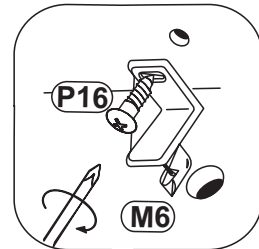
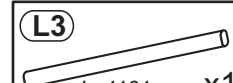
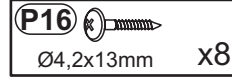
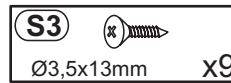

7

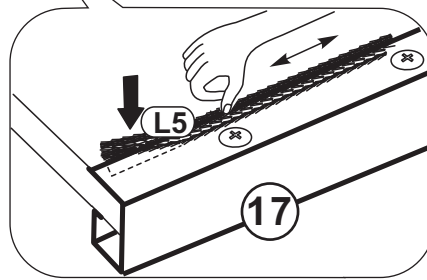
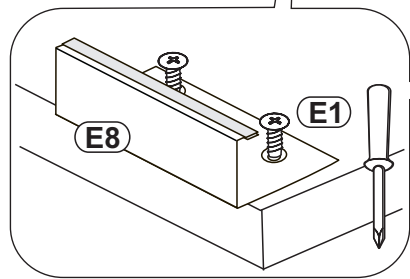
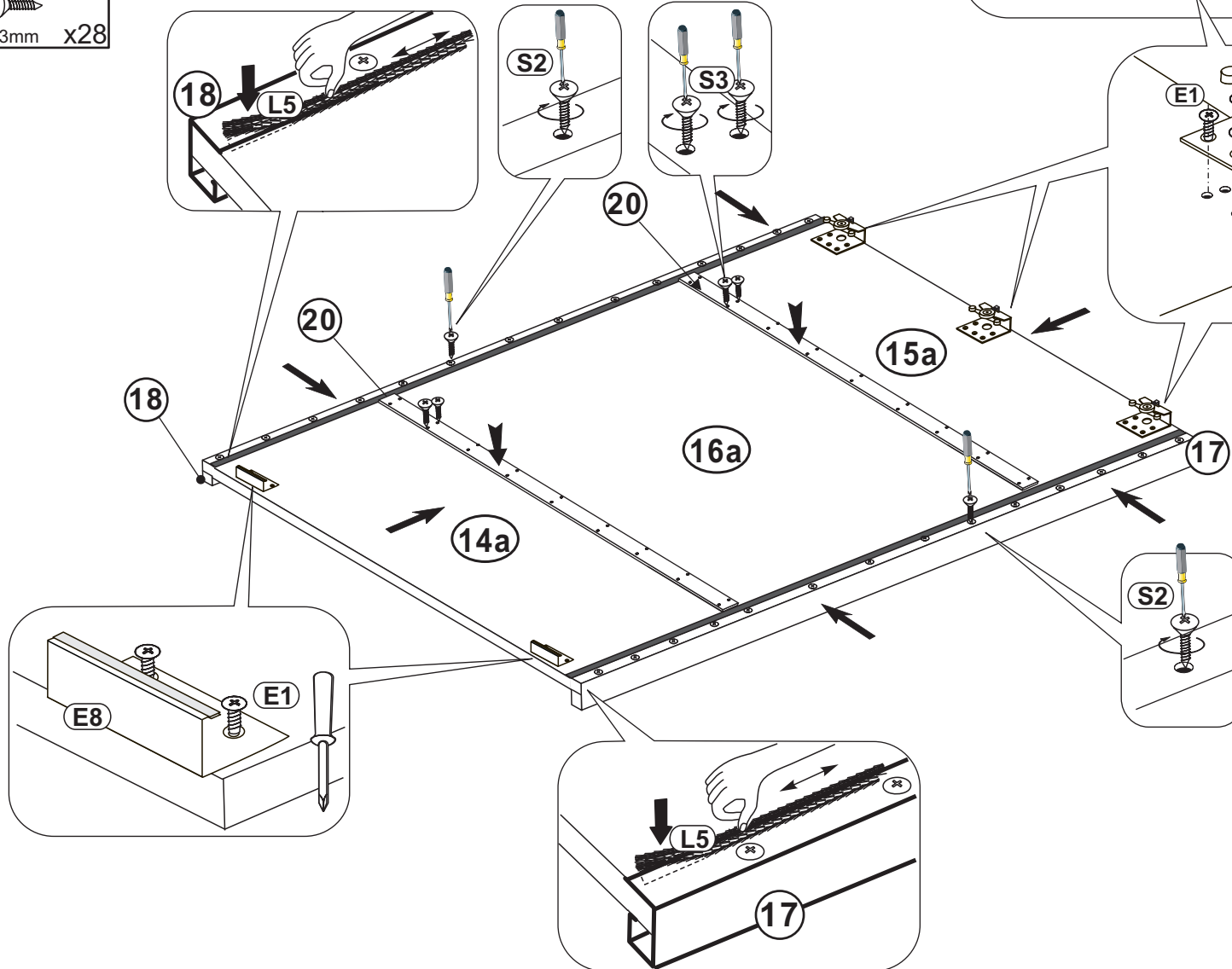
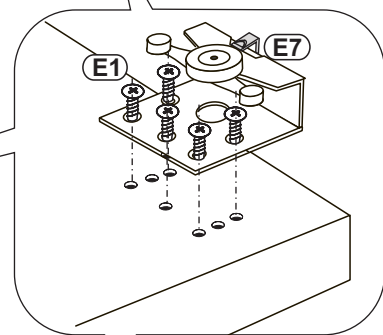
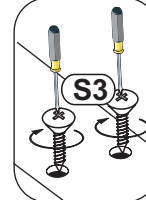
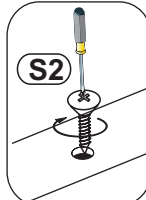
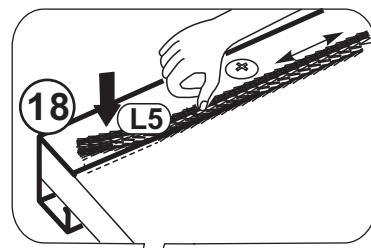
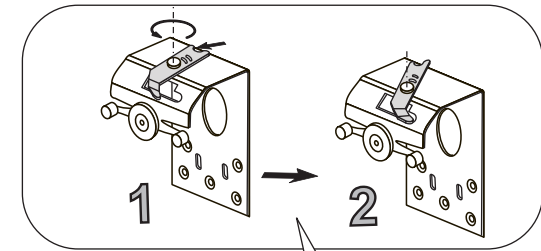
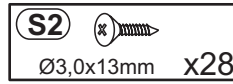
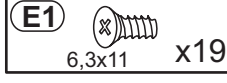
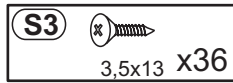
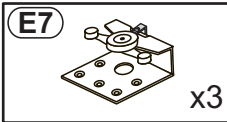
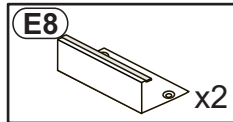



8

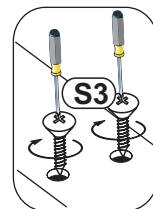
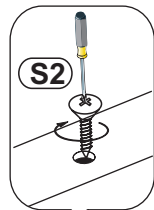
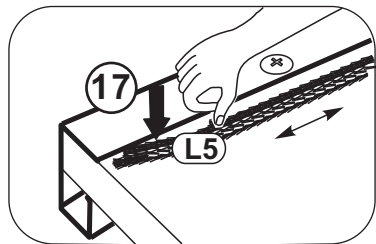
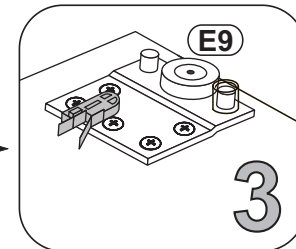
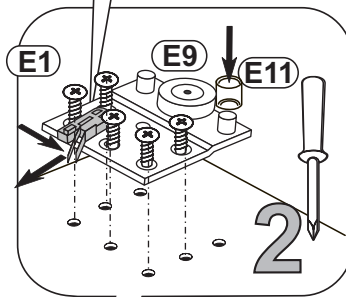
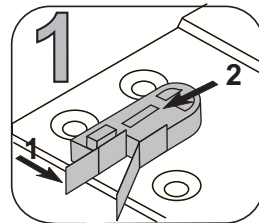
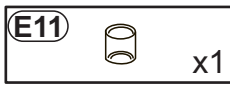
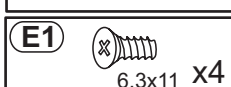
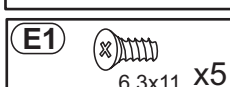
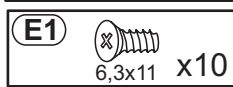
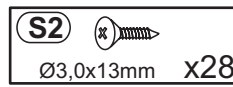
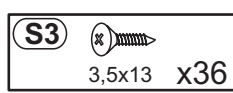
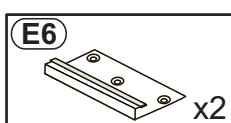
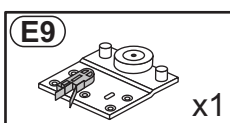
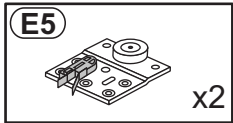

**20**

**17**

**20**

**16**

**15**

**19**

**14**

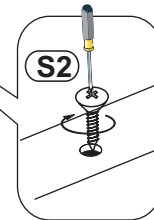
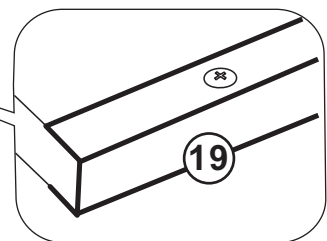
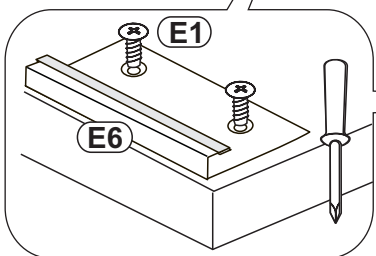
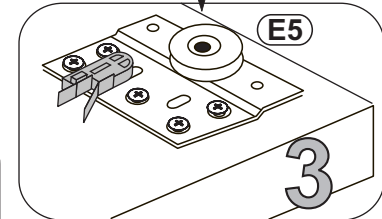
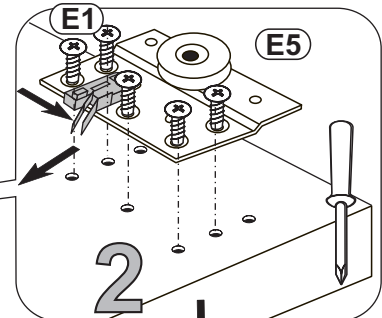



9

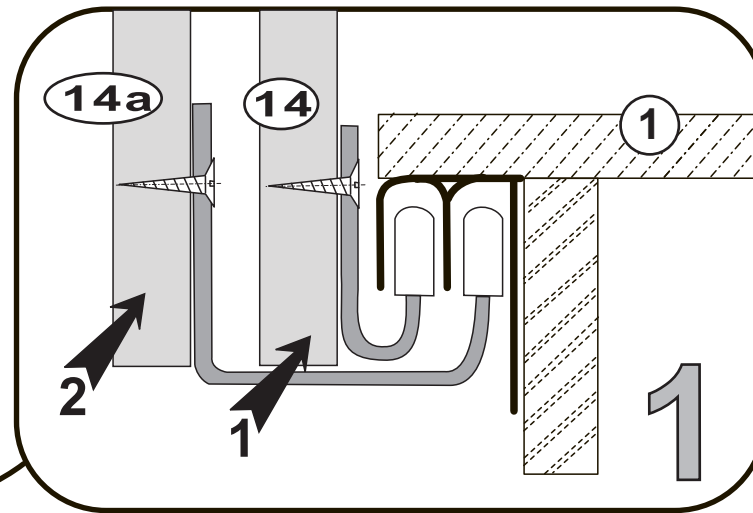
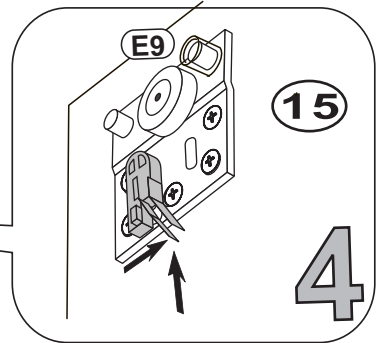
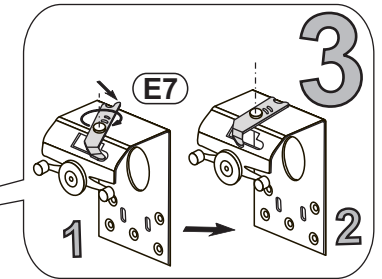
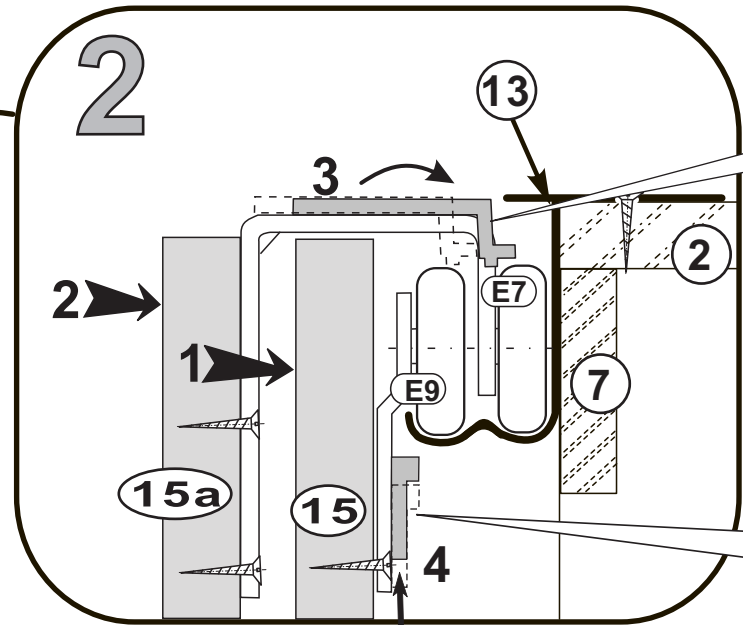
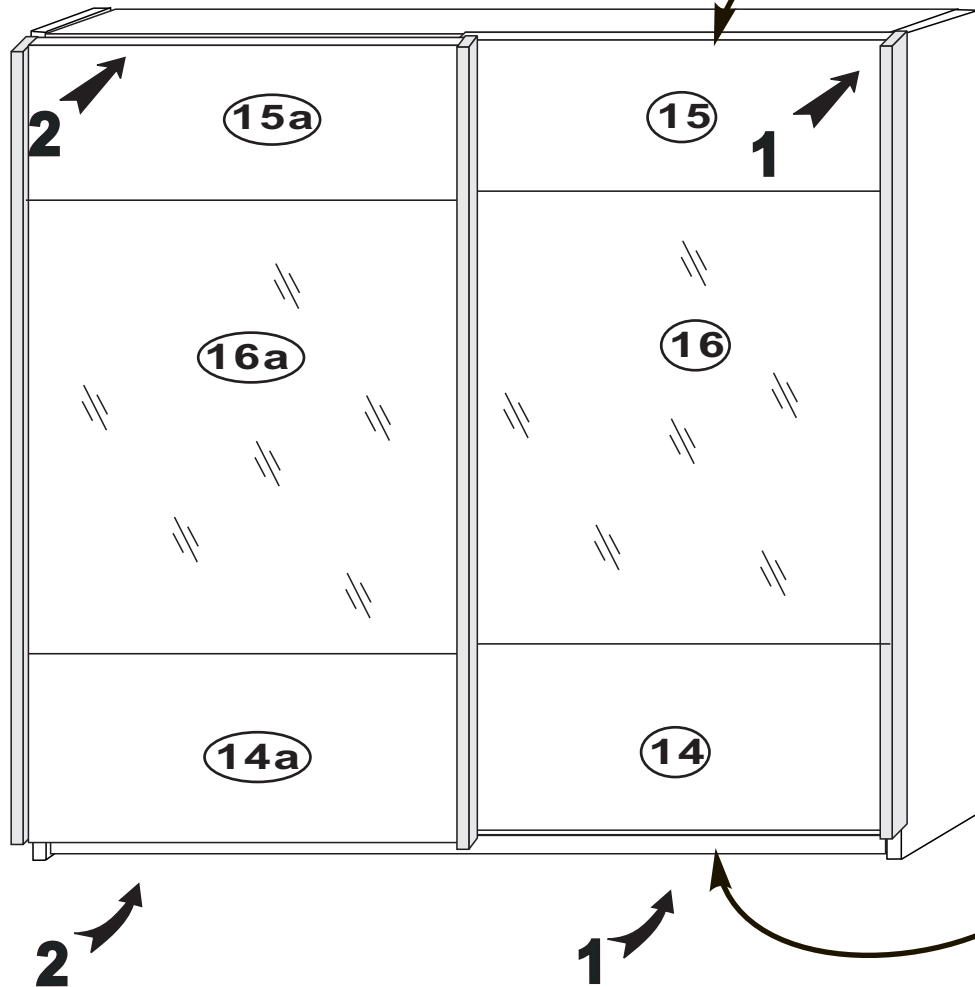

# 10

