





Nr 1

B1  ϕ 8x28 X16

M1  x12

T1  x12

C2  x12

W1  x4

W2  x8

J23  x18

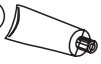
L1  x1

P3  3,5x18 x5

Nr 2

Y0  x5

Y5  x5

S8  4x13 x10

Nr 3

F10  x4

P4  4x25 x4

NR 4

P13  3,5x13 x2

J11  x1

Nr 5

O21  x1

O20  x2



1

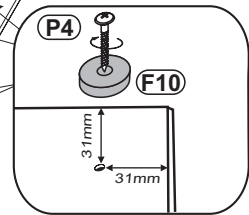
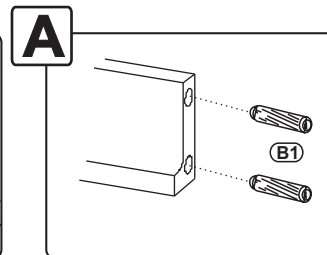
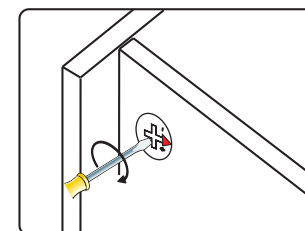
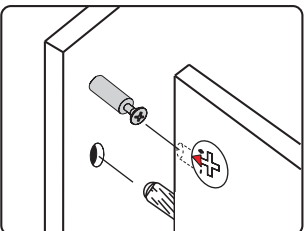
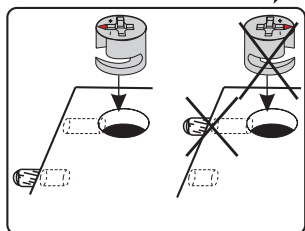
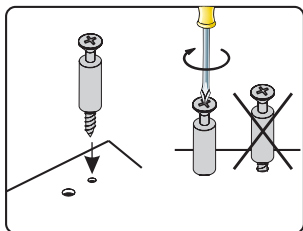
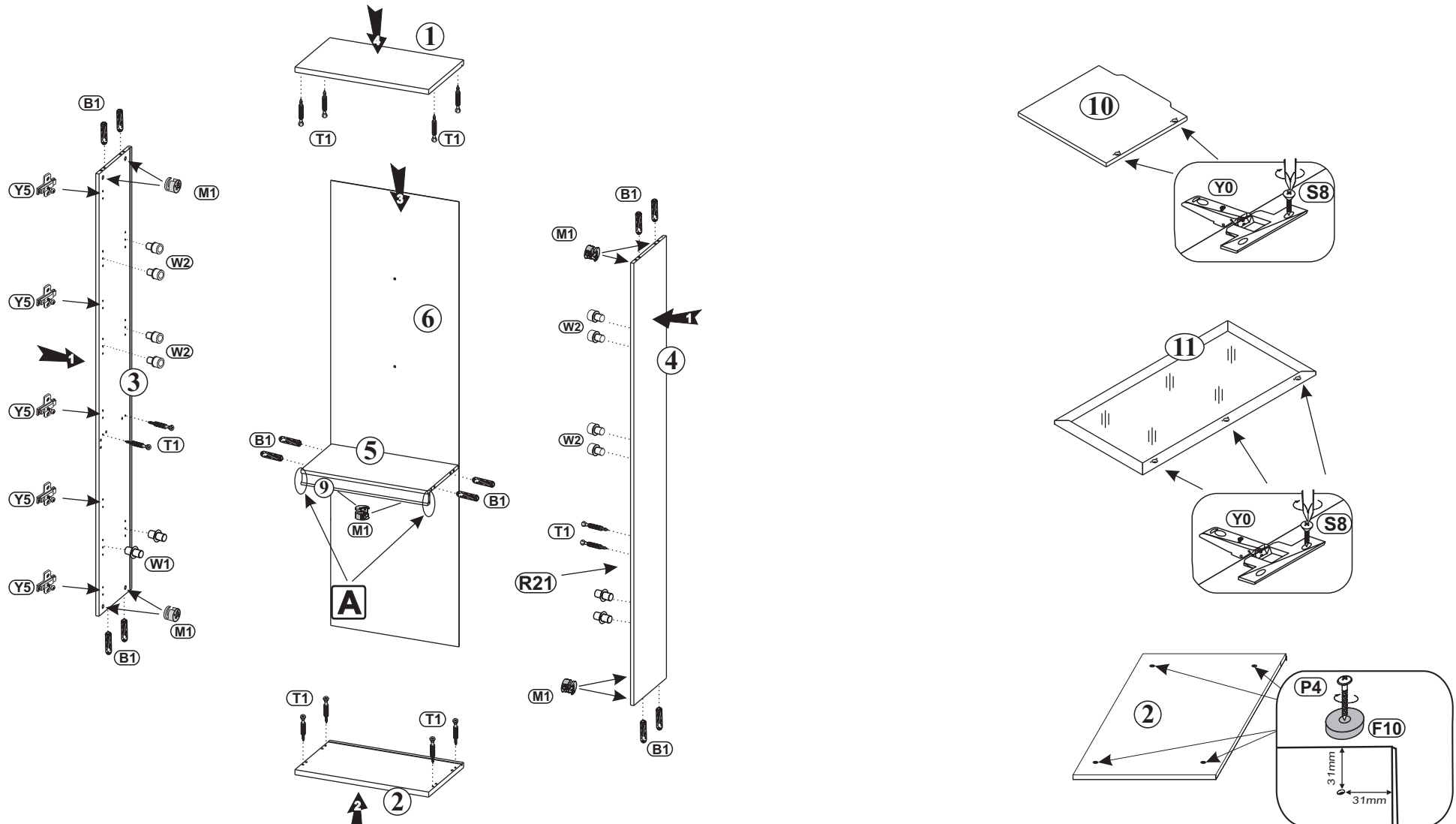

2

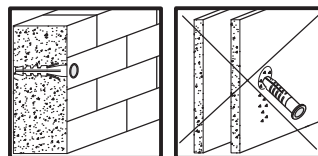
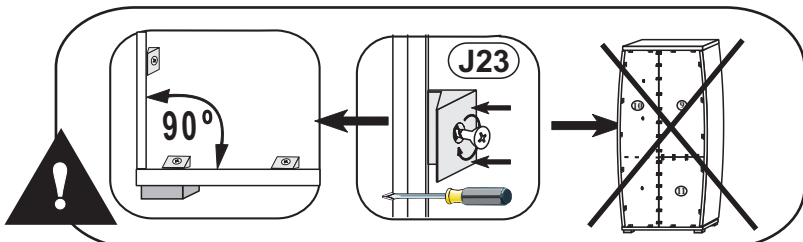
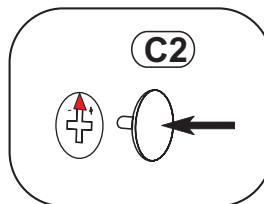
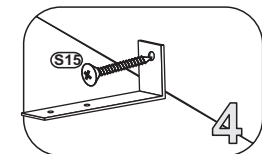
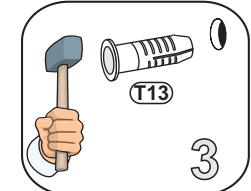
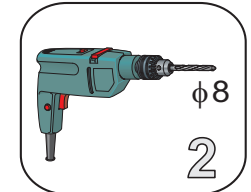
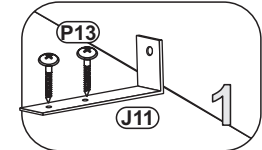
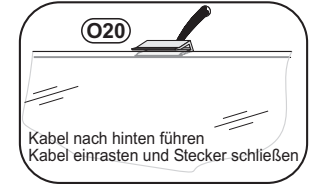
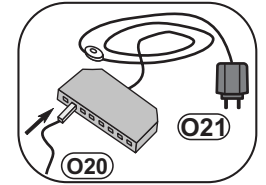
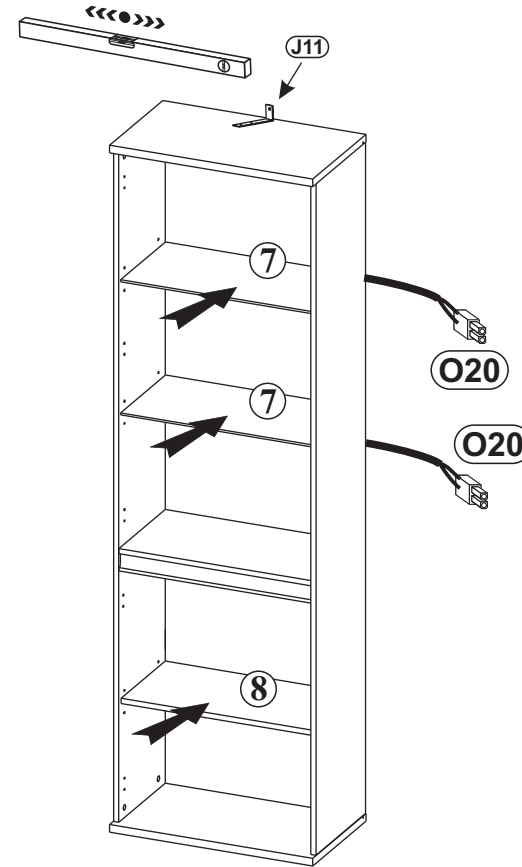
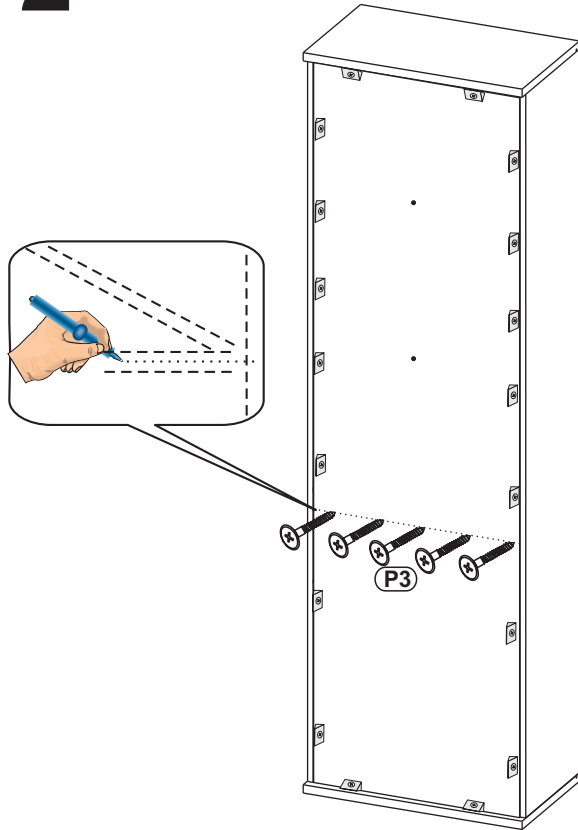

3

