

| REP | DIM     | QTE |
|-----|---------|-----|
| 1   | 605x326 | 2   |
| 2   | 306x325 | 2   |
| 3   | 306x244 | 1   |
| 4   | 563x302 | 1   |
| 5   | 600x333 | 1   |

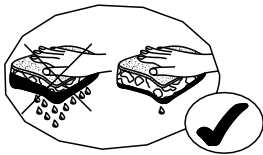

**0h45 Mn**

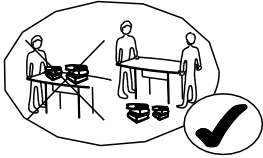
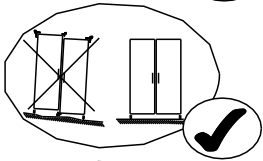
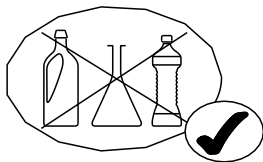

**(FR) SECURITE**  
IMPORTANT-A LIRE SOIGNEUSEMENT-A CONSERVER  
POUR CONSULTATION ULTERIEURE

**(GB) CAUTION**  
IMPORTANT-TO BE READED CARREFULLY-TO BE  
CONSERVED FOR LATER CONSULTATION

**(DE) SICHERHEITSVORSCHRIFTEN**  
WICHTIG-GENAU DURCHZULESEN-AUFZUBEWAHREN  
FÜR SPÄTEREN GEBRAUCH

**(ES) SEGURIDAD**  
IMPORTANTE-LEER CON ATENCION-CONSERVAR  
PARA CONSULTAS POSTERIORES

**(NL) VEILIGHEID**  
BELANGRIJK-ZORGVULDIGGELEZEN TE WORDEN-BEWAARD  
TE WORDEN VOOR LATERE RAADPLEGING

**(IT) SICUREZZA**  
IMPORTANTE-DA LEGGERE ATTENTAMENTE-DA  
CONSERVARE PER CONSULTAZIONE ULTERIORE





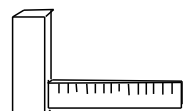
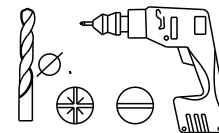
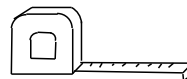
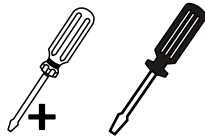



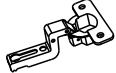
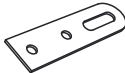
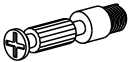

**(PT) SEGURANCA**  
IMPORTANTE-PARA LER COM ATENCAO-PARA  
CONSERVAR PARA COOSULTA ULTERIOR

**(PL) UWAGA**  
WAZNE-UWAZNIE PRZECZYTAĆ-ZACHOWAĆ  
CELEM POZNIJSZYCH KONSULTACJI



0 1 2 3 4 5 6 7 8 9 10



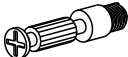

|   |    |   |    |   |    |   |    |  |    |   |    |   |    |
|---|----|---|----|---|----|---|----|--|----|---|----|---|----|
| 706   | X4 | 332194  | X1 | 333009  | X2 | 333010  | X2 | 184  | X2 | 70  | X8 | 71  | X8 |
|   |    |   |    |   |    |   |    |   |    |   |    |   |    |
| 746   | X1 | 340082  | X8 | 331144  | X1 | 907   | X4 | 913  | X2 | 949   | X4 | 604757  | X1 |
|  |    |  |    |  |    |  |    |  |    |  |    |  |    |

|   |    |
|---|----|
| 700   | X1 |
|  |    |

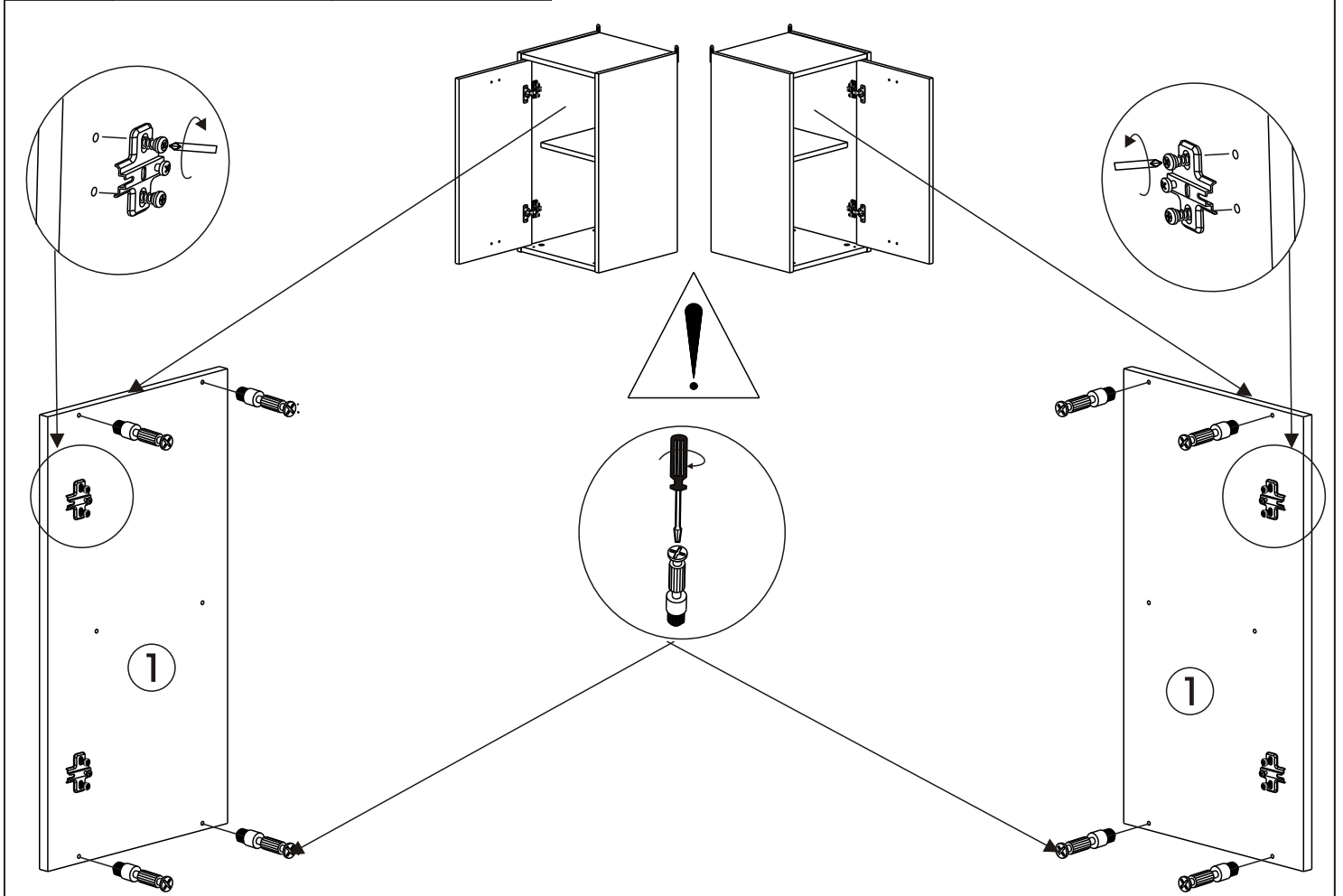
|          |   |    |   |    |
|----------|---|----|---|----|
| <b>1</b> | 333009  | X2 | 70  | X8 |
|          |  |    |  |    |



|          |   |    |   |    |
|----------|---|----|---|----|
| <b>2</b> | 333010  | X2 | 949   | X4 |
|          |  |    |  |    |

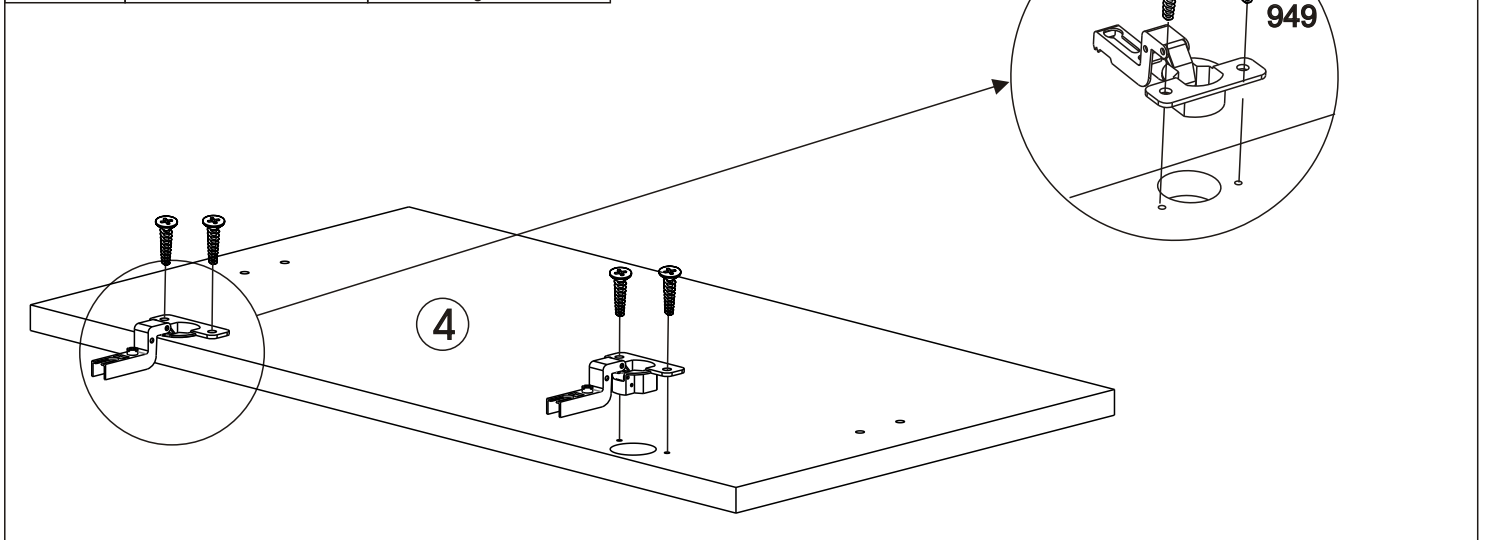

3

71

X8

340082

X8

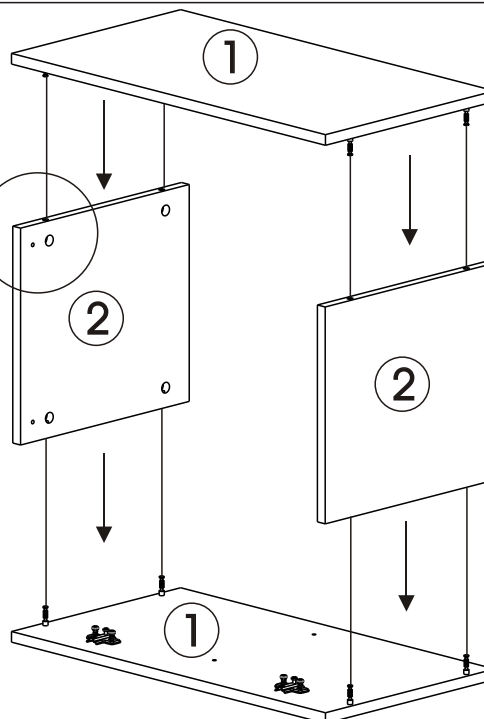
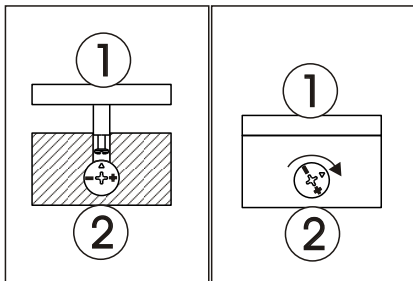
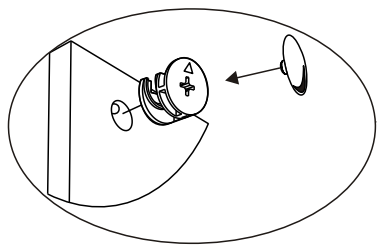

4

604757

X1

331144

X1



X25

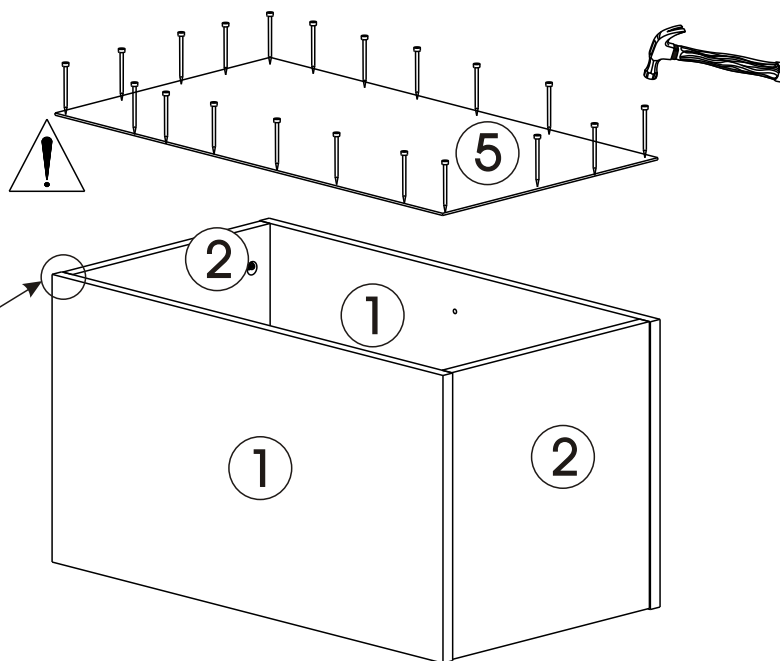
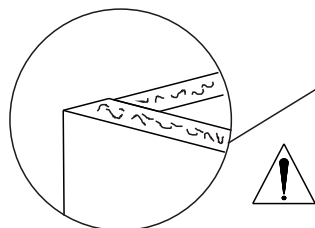
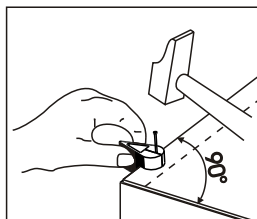

5

184

X2

907

X4

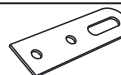

3x16

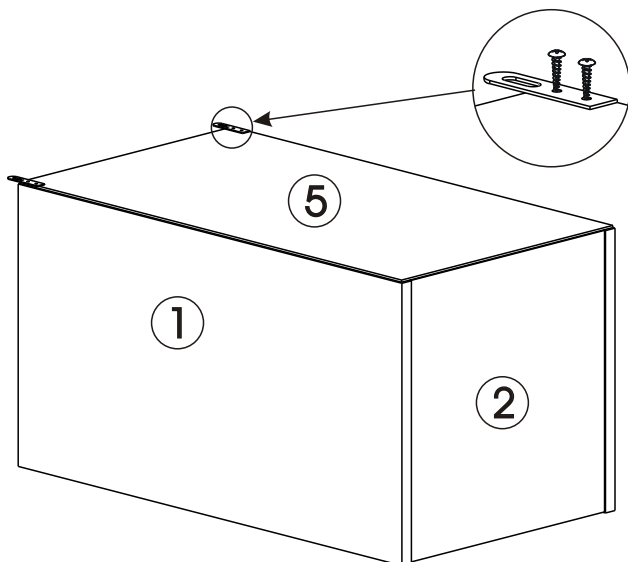

FR

**MUEBLES A FIXER AU MUR:**

- FIXER LE MEUBLE AU MUR AVEC LES ATTACHES PREVUES A CET EFFET
- VERIFIER QUE LES VIS ET LES CHEVILLES UTILISEES SONT ADAPTEES AU SUPPORT

ES

**MUEBLES A FIJAR EN LA PARED:**

- FIJAR EL MUEBLE EN LA PARED CON LAS GRAPAS PREVISTAS
- COMPROBAR QUE LOS TORNILLOS Y LAS CLAVIJAS UTILIZADAS SON ADAPTADAS AL SOPORTE

PT

**MOVEIS A FIXAR NA PAREDE:**

- FIXAR O MOVEL NA PAREDE COM OS PRENDES PREVISTOS
- VERIFICAR QUE OS PARAFUSOS E AS CAVILHAS UTILIZADOS SAO ADAPTADOS OA SUPORTE

EN

**FURNITURES TO BE HOLD ON THE WALL:**

- HOLD THE FURNITURE ON THE WALL WITH THE FASTENINGS PROVIDED FOR THIS PURPOSE
- CHECK THAT THE SCREW AND PEGS FIT WITH THE SUPPORT

IT

**MOBILI DA FISSARE AL MURO:**

- FISSARE IL MOBILE AL MURO CON LE FLANGIE PREVISTE A TALE SCOPO
- VERIFICARE CHE LE VITI ED I PERNI USATI SIANO ADATTI A QUEL TIPO DI SUPPORTO

PL

**MEBEL PRZEZNACZONY DO ZAINSTALOWANIA NA SCIANIE:**

- NALEZY ZAMONTOWAC TEN MEBEL NA SCIANIE PRZEZNACZONYMI DO TEGO CELU UCHWYTAMI
- NALEZY SPRAWDZIC CZY SRUBY I KOSZULKI SA ODPOWIEDNIEJ WIELKOSCI W STOSUNKU DO UCHWYTOW

DE

**MOEBEL AN DER MAUER ZU BEFESTIGEN:**

- BEFESTIGEN SIE DAS MOEBELSTUECK MIT DEN DAFUER VORGEGEHENEN BEFESTIGUNGSHAKEN
- UEBERPRUEFEN SIE BITTE DASS DIE SCHRAUBEN UND DUEBEL MIT DEM MATERIAL DER MAUER UEBEREINSTIMMEN

NL

**MEUBELS DIE AAN DE MUUR GEFIXEERD MOETEN WORDEN:**

- FIXEER HET MEUBEL AAN DE MUUR MET DE DAARVOOR BESTEMDE HAKEN
- VERFIEER OF DE GEBRUIKTE SCHROEVEN BIJ DE BEVESTIGINGSHAAK HOREN

# 6

706

X4

746

X1

700

X1

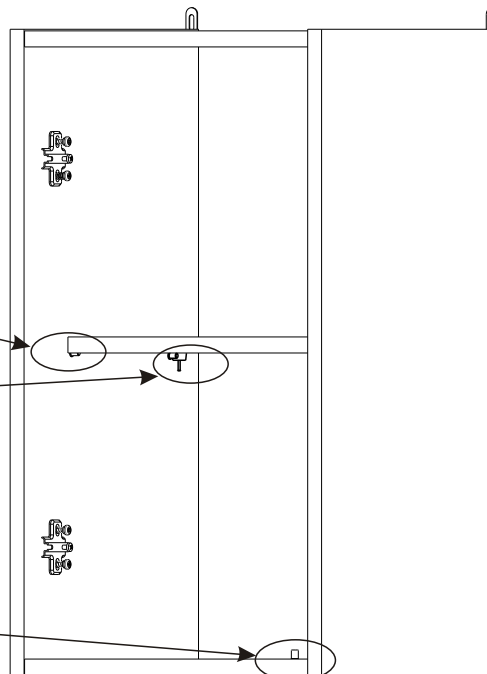
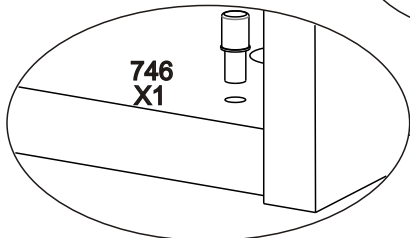
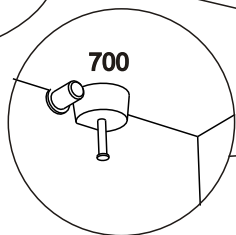
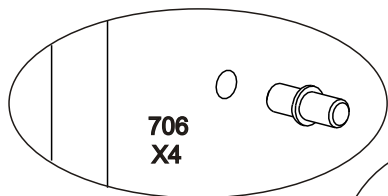

# 7

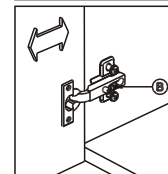
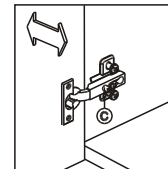
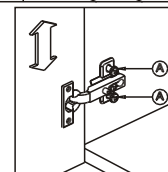
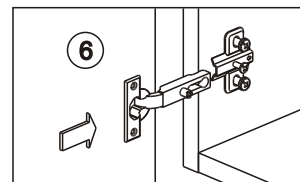
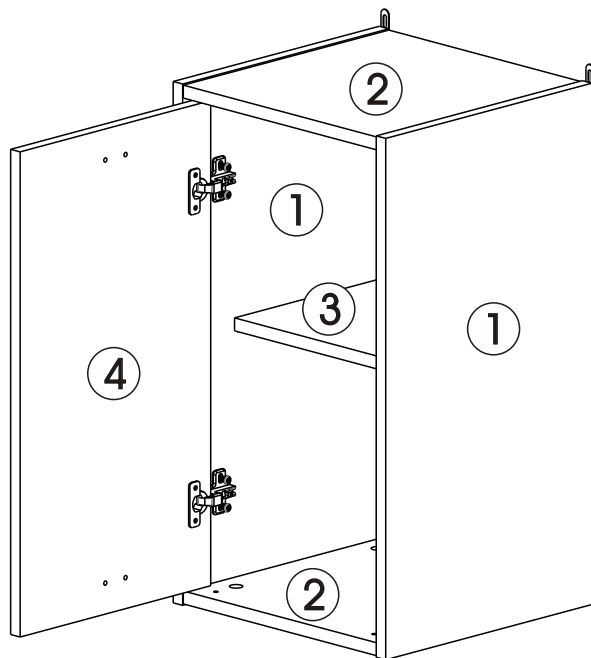

# 8

332194

X1

913

X2

