





NR 1

(B1)  8x28 x28

(B2)  8x50 x20

(B3)  6x45 x48

(M1)  x56+16

(T1)  x48+16

(W1)  x32

(T12)  L=24/40 x4

(K1)  7x50 mm x2

NR 2

(C2)  x72

(C1)  x2

(S4)  3,0x20 x13

(M6)  x12

(P16)  4,2x12 x12

(F15)  x6

NR 3

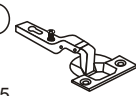
(Y1)  Kr15 x8

(Y5)  H2 x8

(S8)  4x13 x16

(E3)  6,3x13 x16

NR 4

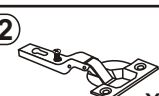
(Y2)  Kr8 x8

(Y5)  H2 x8

(S8)  4x13mm x16

(E3)  6,3x13mm x16

NR 5

(U61)  x2

(A14)  M4x23 x4

NR 6

(F7)  x2

(S1)  3,0x13mm x2

NR 7

(J11)  x2

(P13)  3,5x13 mm x4

NR 8

(G7)  x2



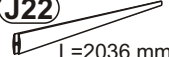

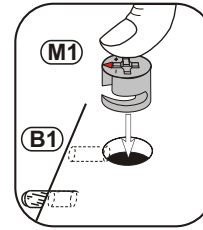
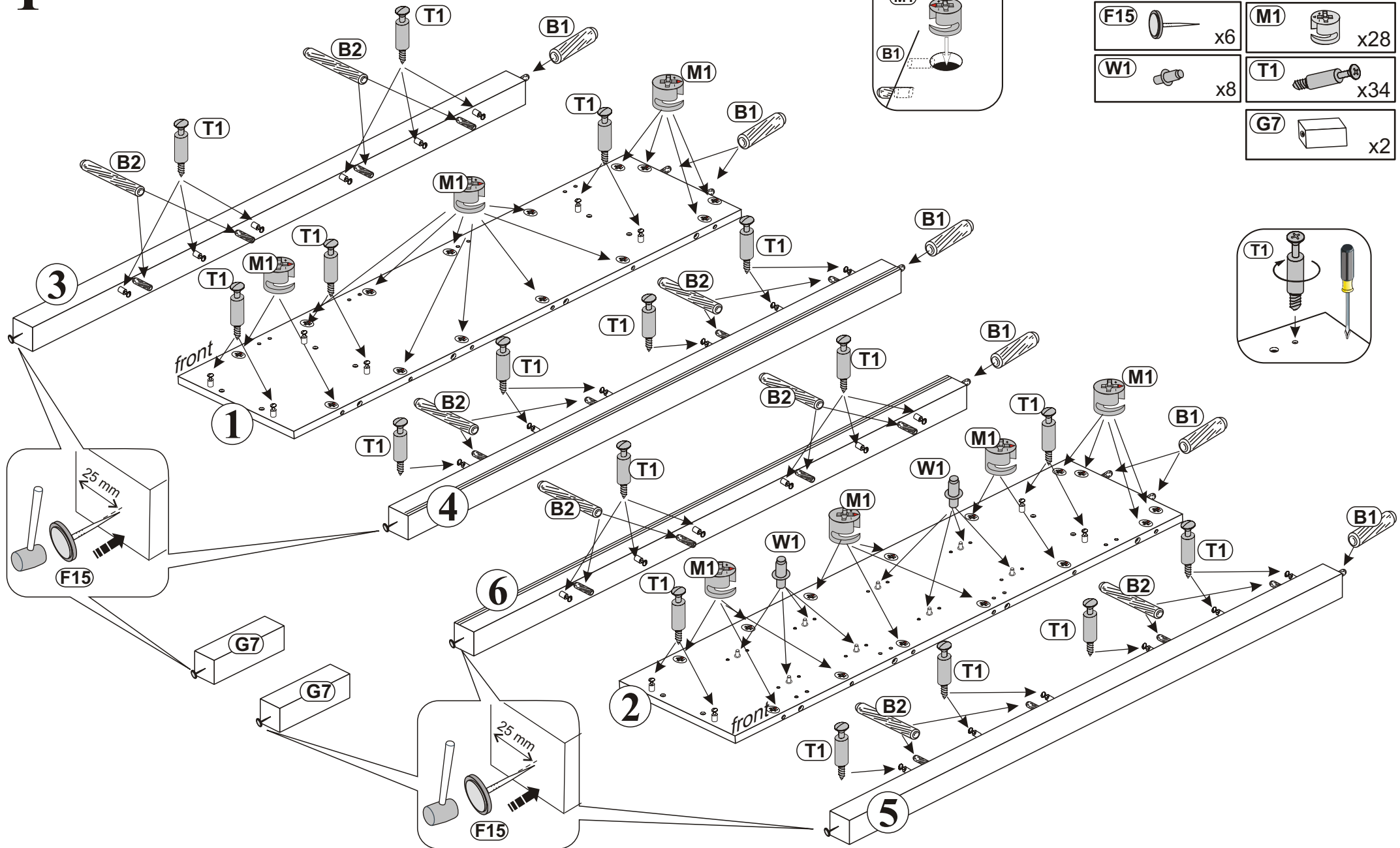

(J20)  L=973mm x1

(J22)  L=2036 mm x1



1



B2  8x50 x16	B1  8x28 x8
F15  x6	M1  x28
W1  x8	T1  x34
G7  x2	

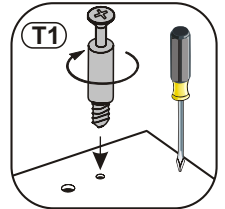

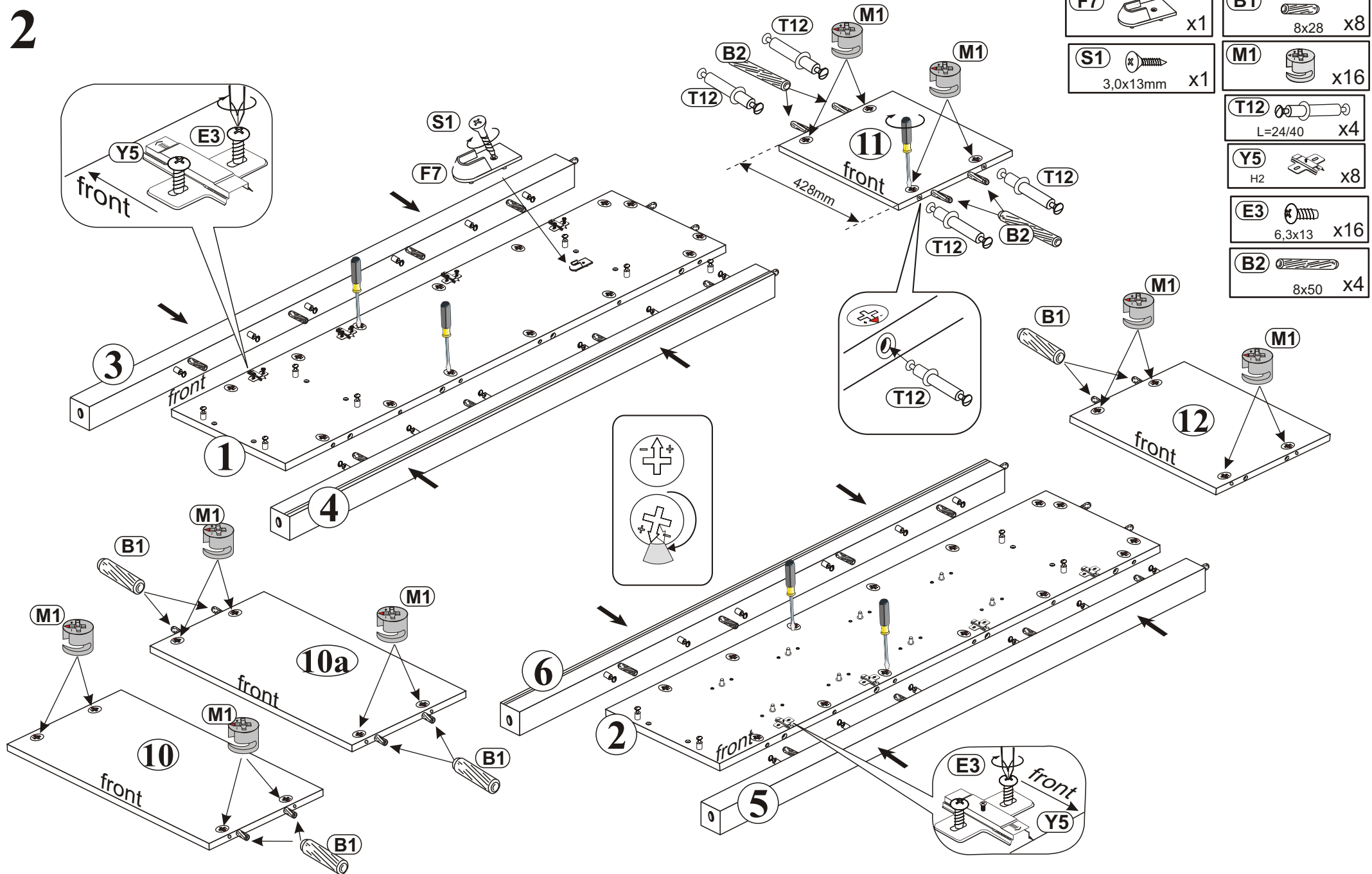

2

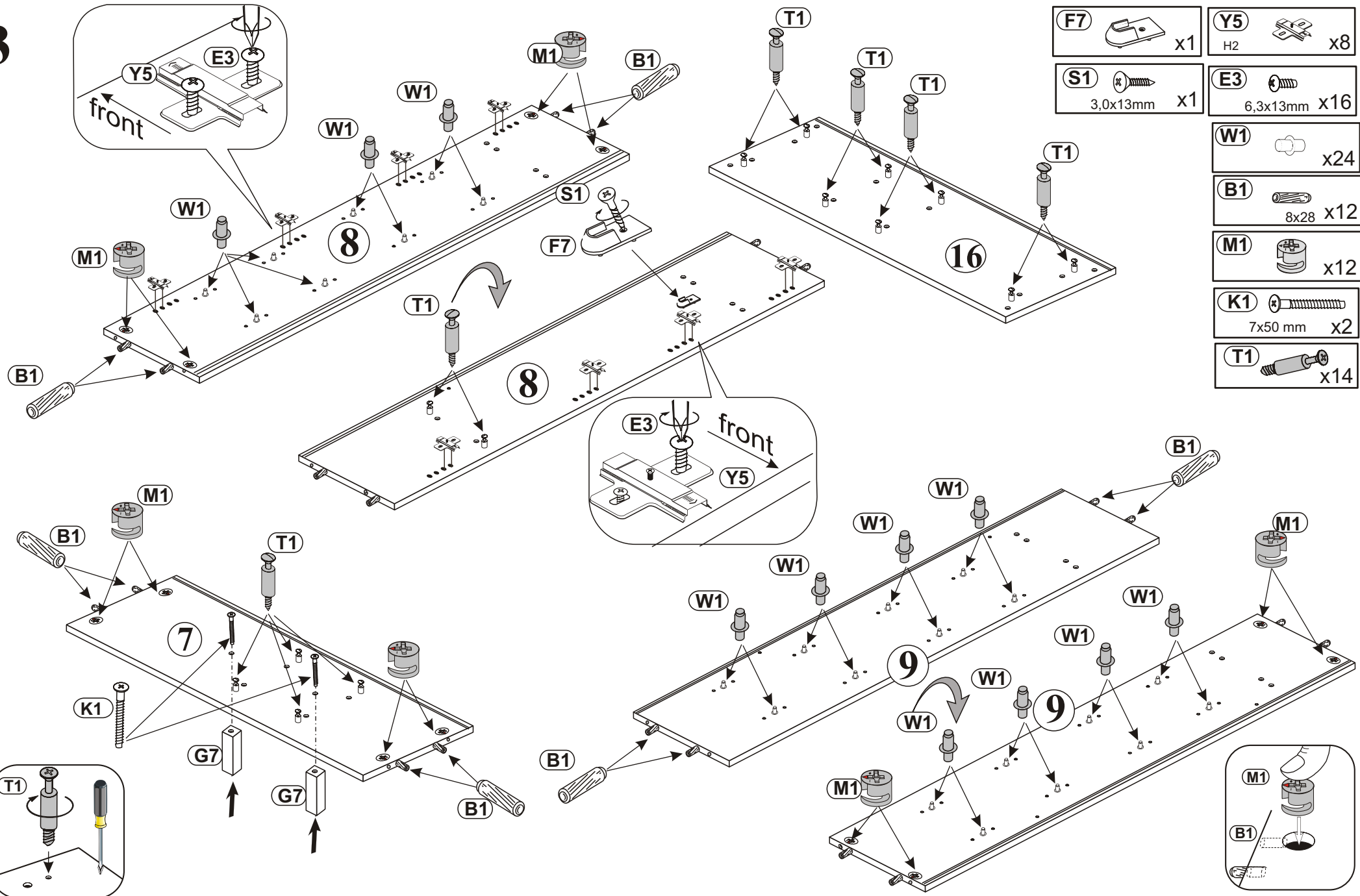

3





F7  x1

Y5  x8
H2

S1  x1
3,0x13mm

E3  x16
6,3x13mm

W1  x24

B1  x12
8x28

M1  x12

K1  x2
7x50 mm

T1  x14

4

- P16** 4,2x12 x4
- M6** x4
- C1** x2

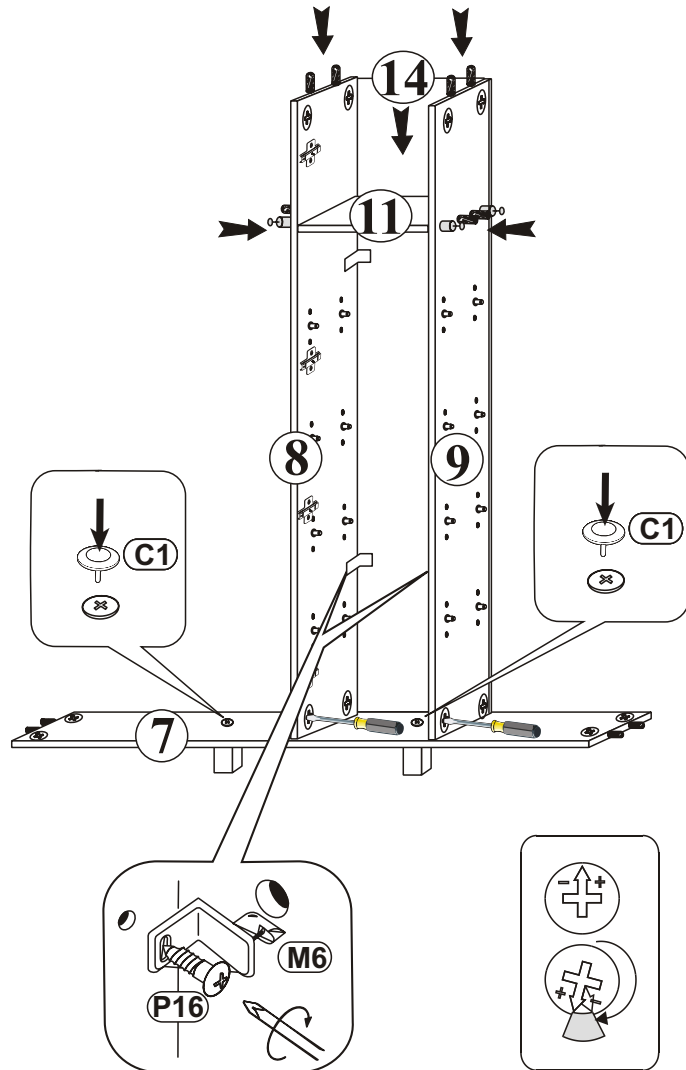

5

- P16** 4,2x12 x8
- M6** x8
- J22** L=2036 mm X1

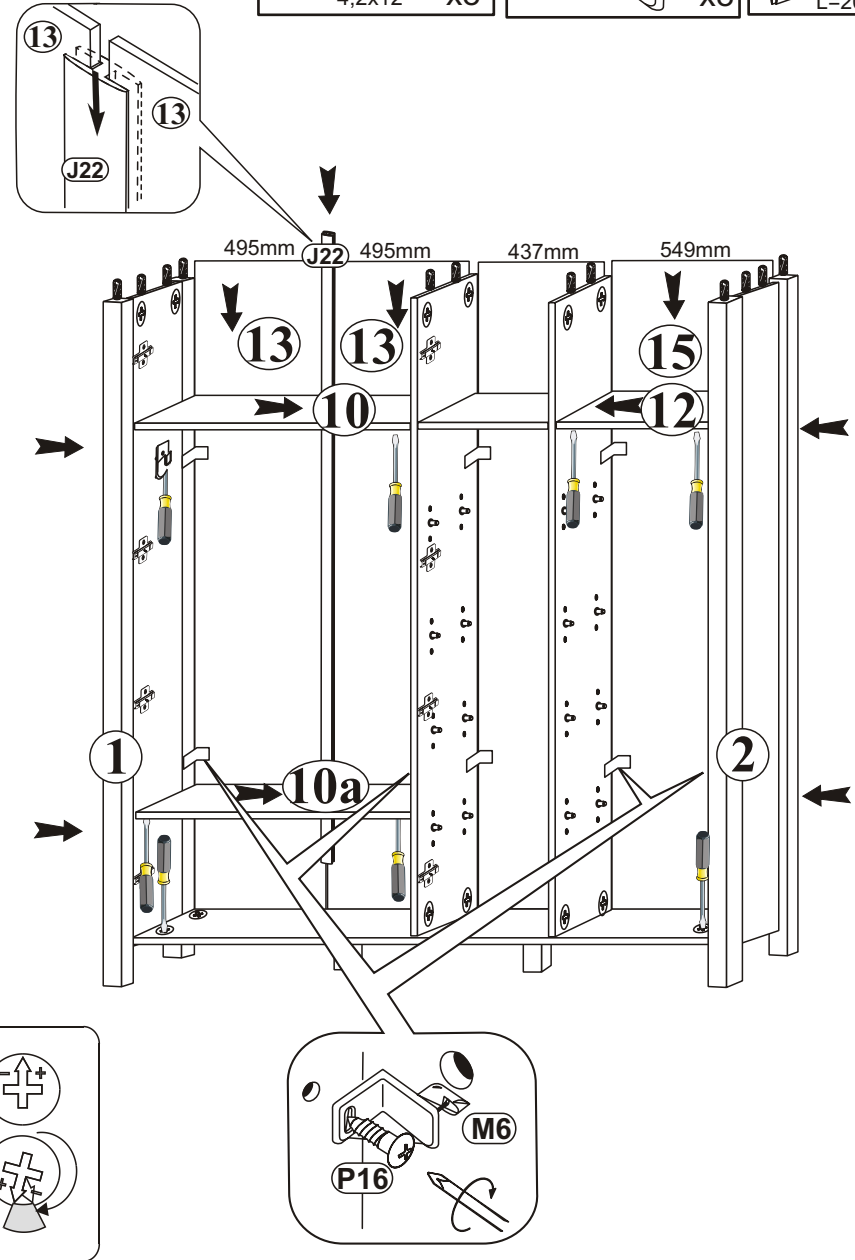

6

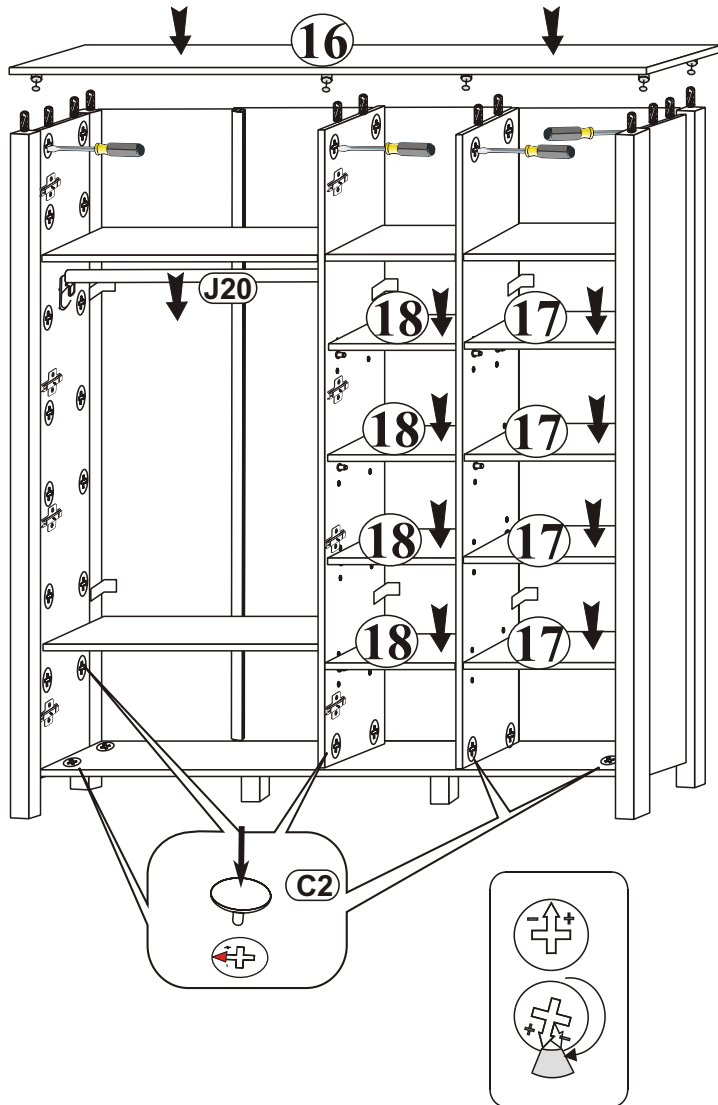
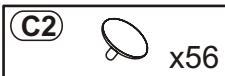
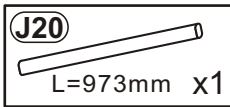



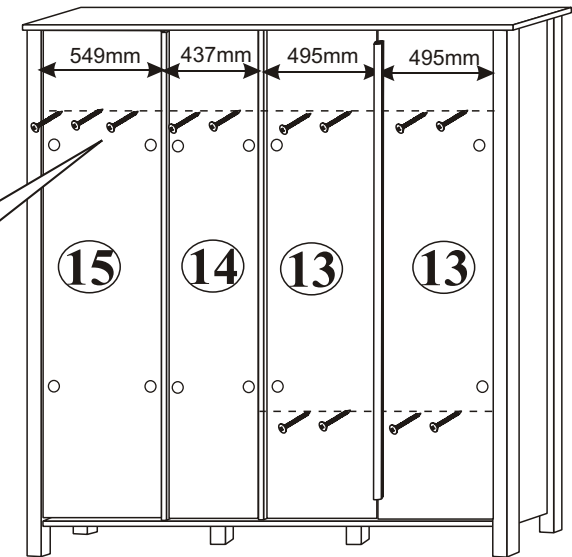
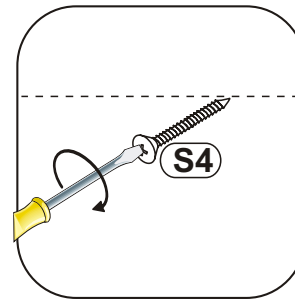
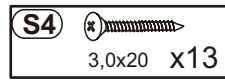

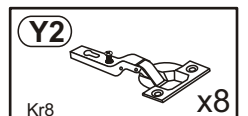
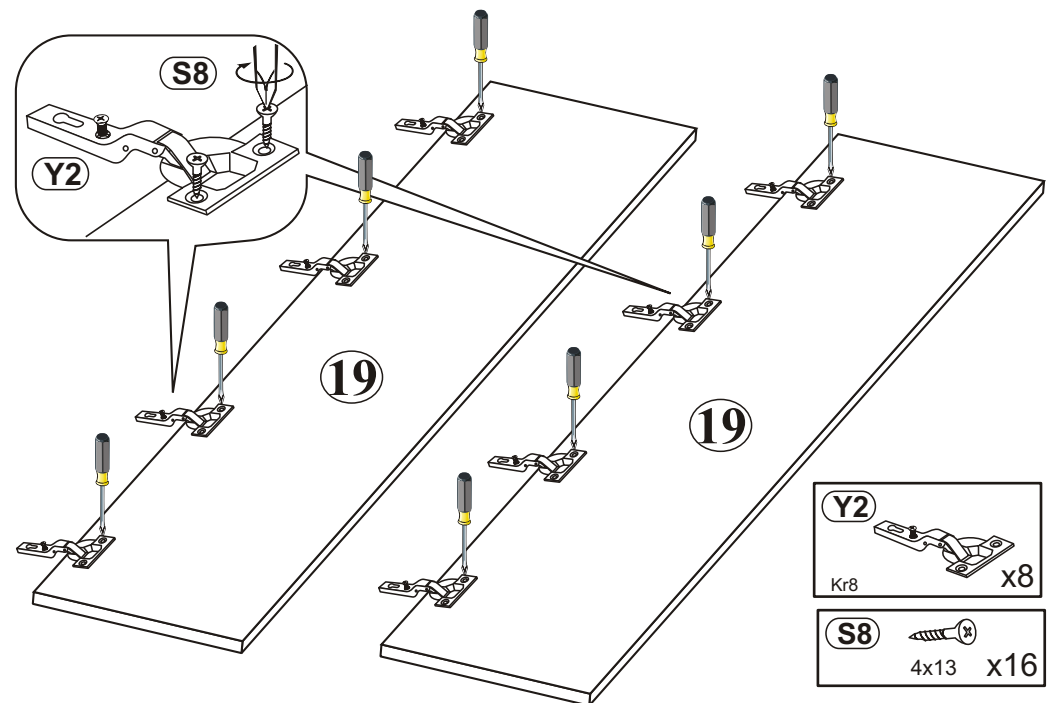
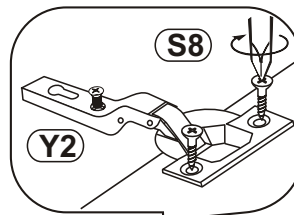

7

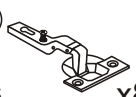

8

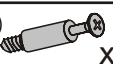

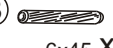
9

- | | | |
|---|--|--|
| M1
 x16 | Y1
 Kr15 x8 | U61
 x2 |
| T1
 x16 | A14
 M4x23 x4 | C2
 x16 |
| B3
 6x45 X48 | S8
 4x13 mm x16 | |

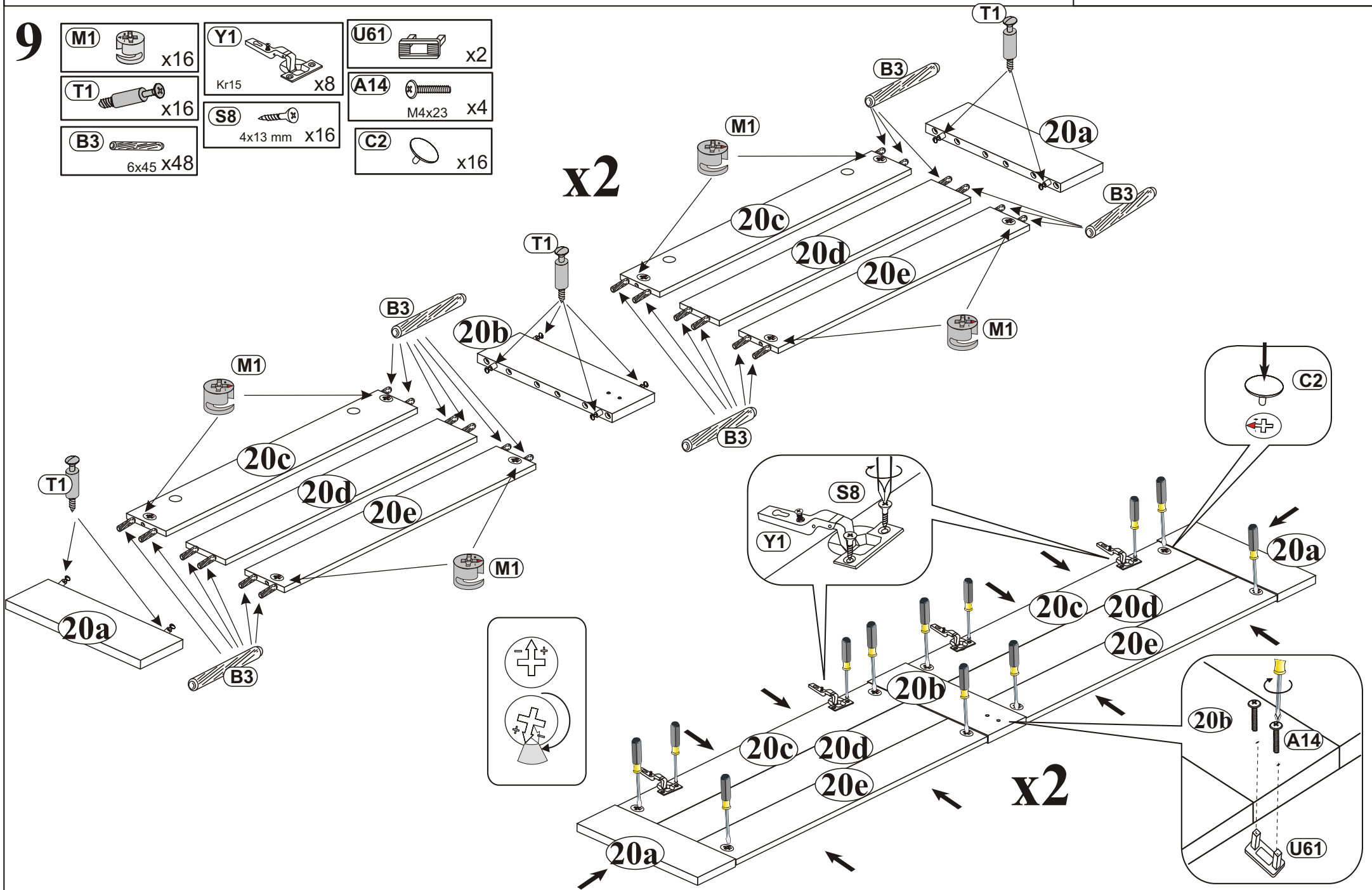

10

