

A	B	C	D	
1	S83-010	844	176	4/4
2	S83-122	669	372	1/4
3	S83-123	669	372	1/4
4	S83-124	651	100	1/4
5	S83-204	1000	452	2/4
6	S83-312	926	429	2/4
7	S83-401	848	60	2/4
8	S83-575	90	60	3/4
9	S83-594	702	76	3/4
10	S83-595	702	76	3/4
11	S83-596	778	76	3/4
12	S83-597	778	76	3/4
13	S83-912	810	398	1/4
14	S83-913	955	679	1/4
15	ZS1-517	400	120	1/4
16	ZS1-518	400	120	1/4
17	ZS1-6536	799	120	1/4

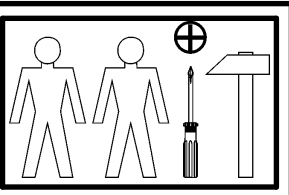

12x φ5x9 mm e19	6x φ7x28 mm e22	12x φ6x13 mm e3	36x φ8x30 mm f1	4x φ8x20 mm f13	12x φ6.5x40 mm f25	4x M6/φ8x14 mm k39\2	4x M6/22mm k39\3	50x l1
6x φ3.5x16 mm p25	18x φ15x12mm #16 r1	12x φ12x10.5mm #12 r15	30x r42	3x 383 mm t14	3x 400 mm w5\CL	3x 400 mm w5\CR	3x 400 mm w5\DL	3x 400 mm w5\DR
1x z1	1x n26\1	1x φ3.5x16 mm p38						

1

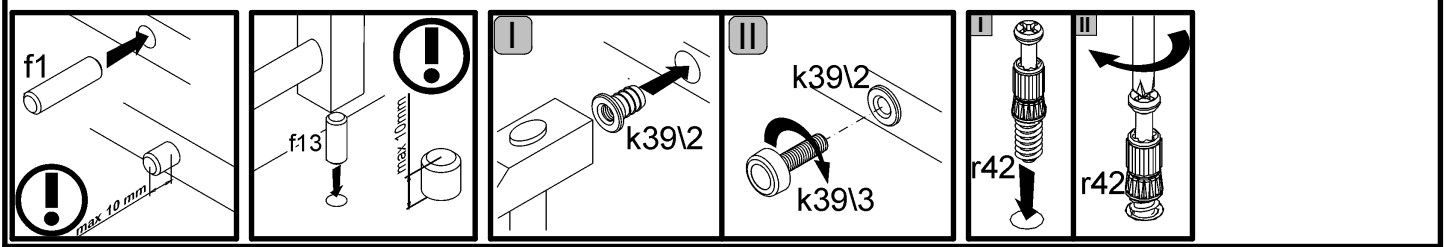
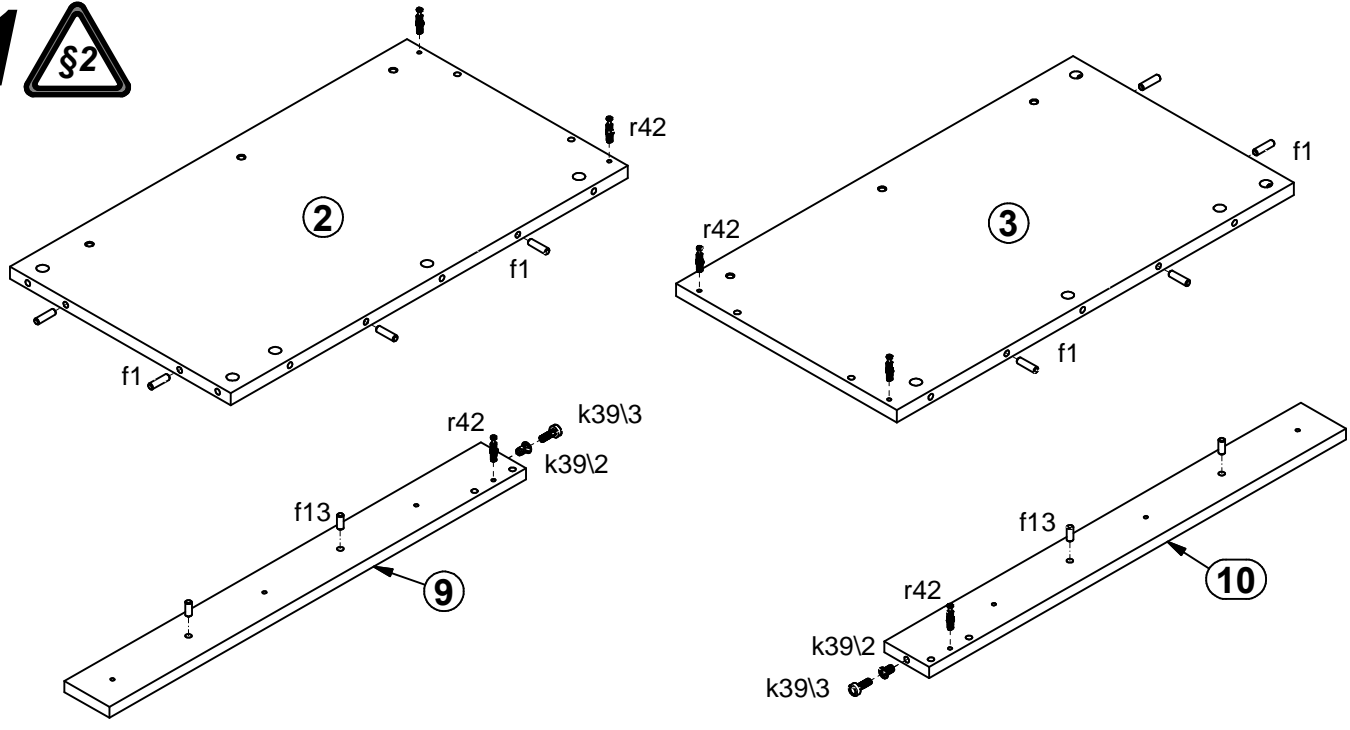

2

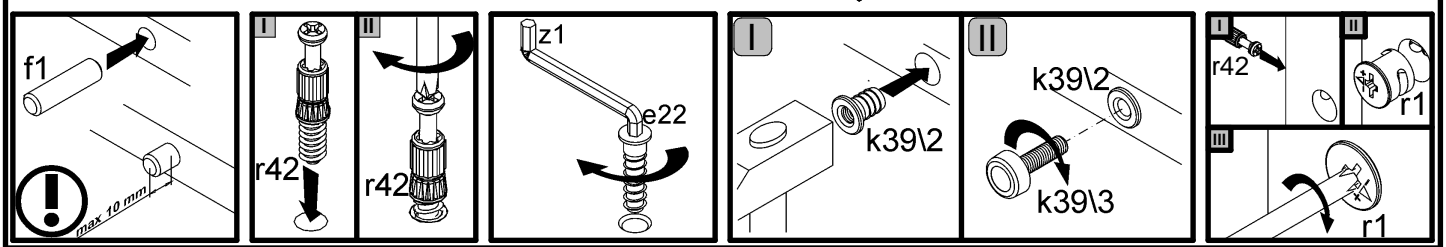
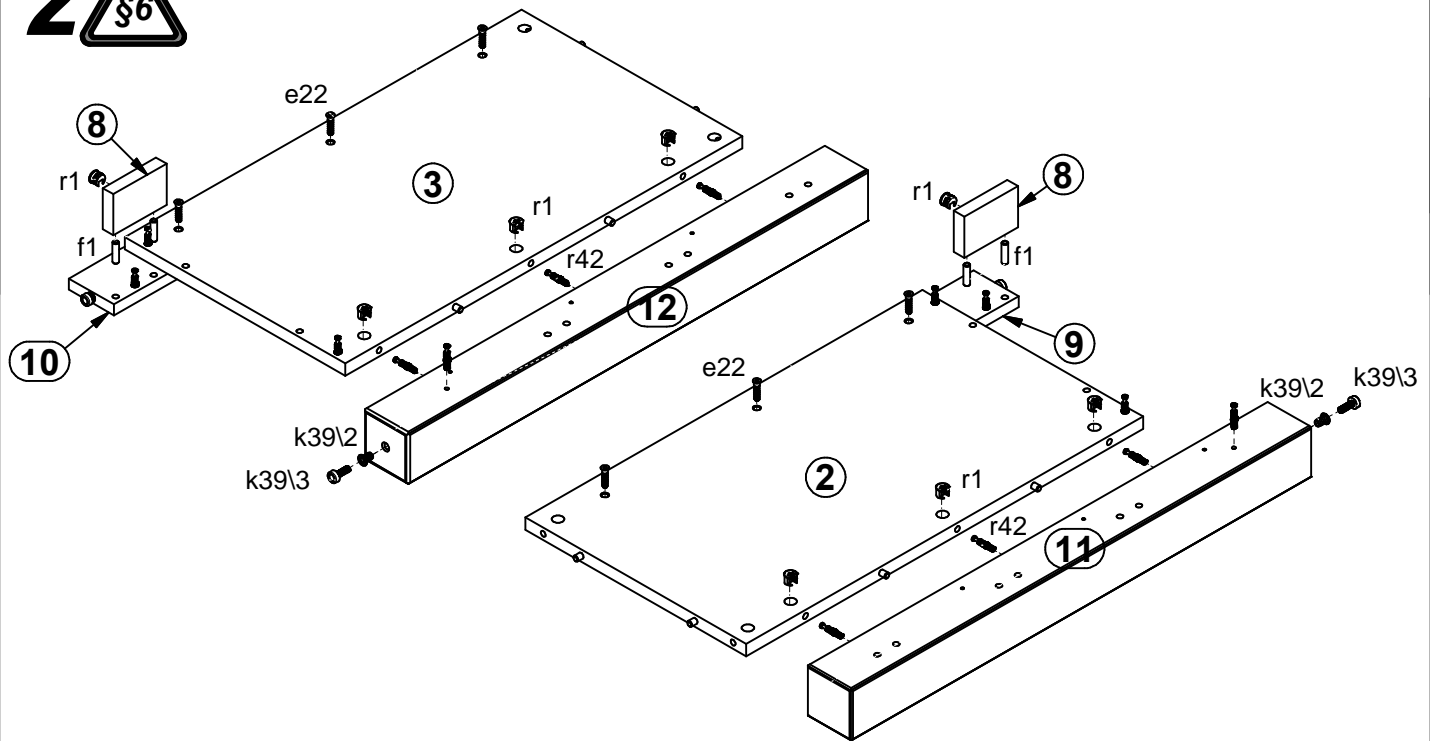

3

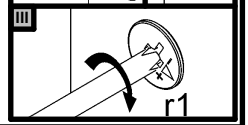
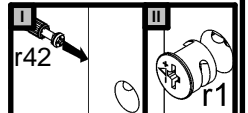
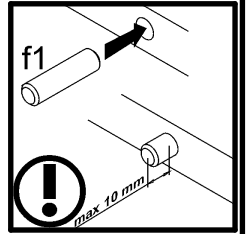
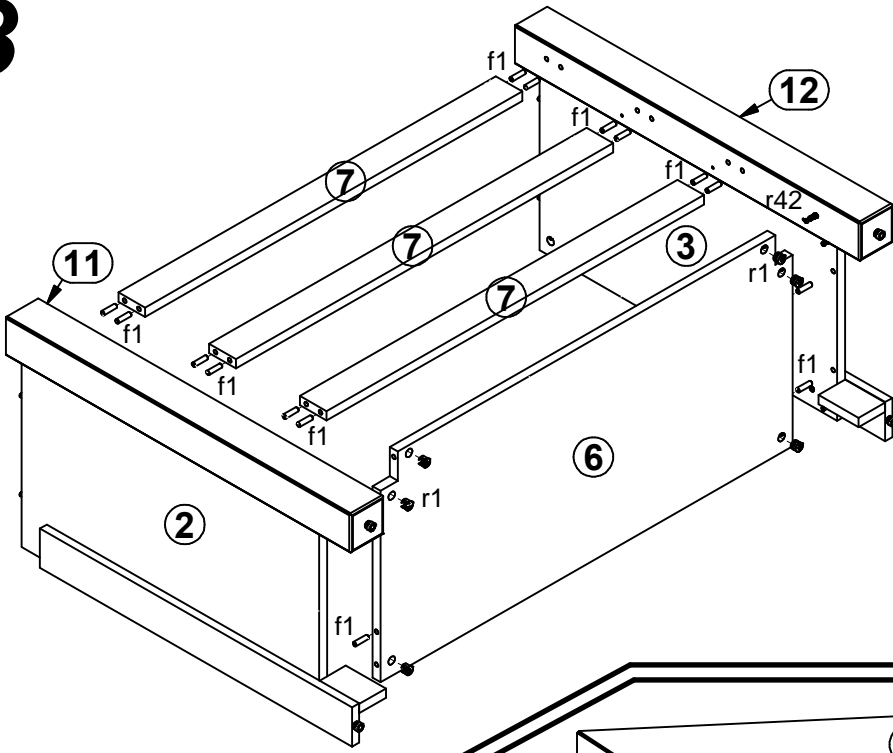

4

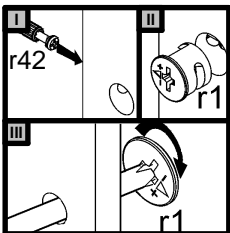
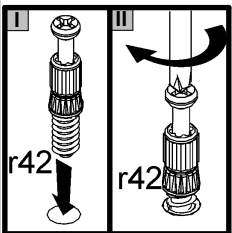
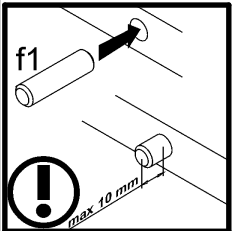
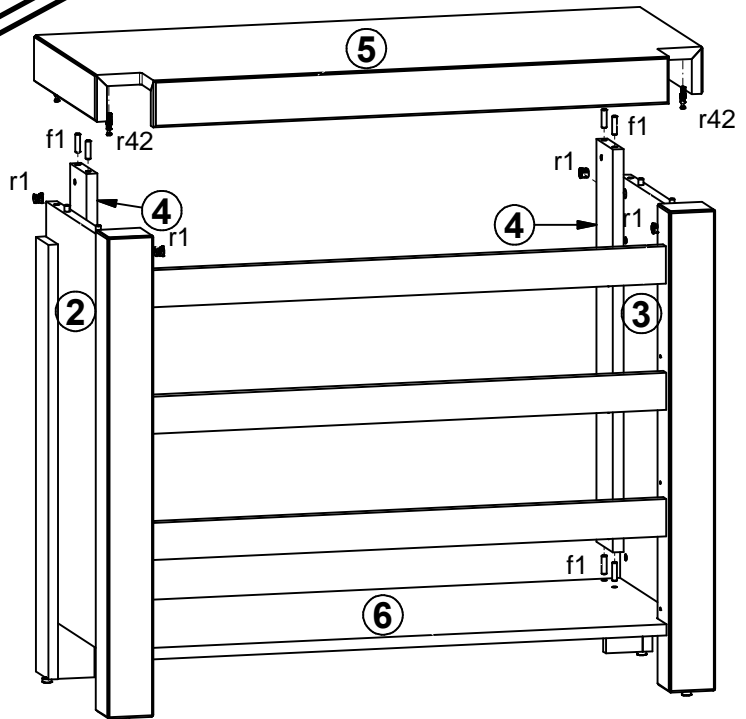

5

