





1

L1  x1

T6  x12

M1  x14

T1  x14

B1  ϕ 8x28mm x16

K1  ϕ 7x50mm x3

C1  ϕ 2 x3

W1  x24

M6  x14

P16  ϕ 4,2x13mm x14

C2  x14

F1  x8

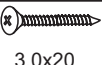
S4  3,0x20 x8

2

F7  x2

S2  ϕ 3,0x13mm x2

3

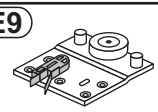
E9  x1

E1  ϕ 6,3x11mm x5

E11  x1

4

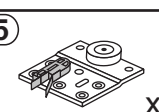
E5  x1

E1  ϕ 6,3x11mm x5

5

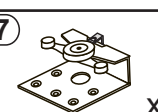
E7  x2

E1  ϕ 6,3x11mm x10

6

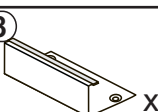
E8  x2

E1  ϕ 6,3x11mm x4

7

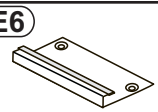
E6  x2

E1  ϕ 6,3x11mm x4

8

S3  ϕ 3,5x13mm x8

L4  x2

L5  L=1974 mm x2

S2  ϕ 3,0x13mm x64

9

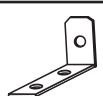
J11  x2

P13  ϕ 3,5x13 mm x4

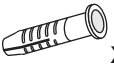
T13  ϕ 8x40 x2

S15  x2

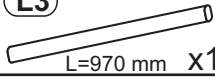

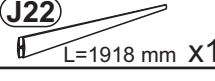

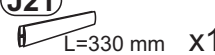

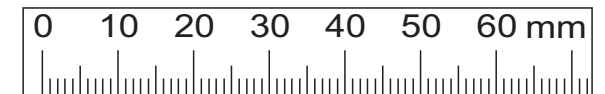
L3  L=970 mm x1

J22  L=1918 mm x1

J21  L=330 mm x1



1

| | | |
|--|--|--|
| T6  x8 | F7  x2 | B1  ϕ 8x28 x4 |
| T1  x6 | S2  ϕ 3,0x13mm x2 | M1  x4 |
| | | W1  x6 |

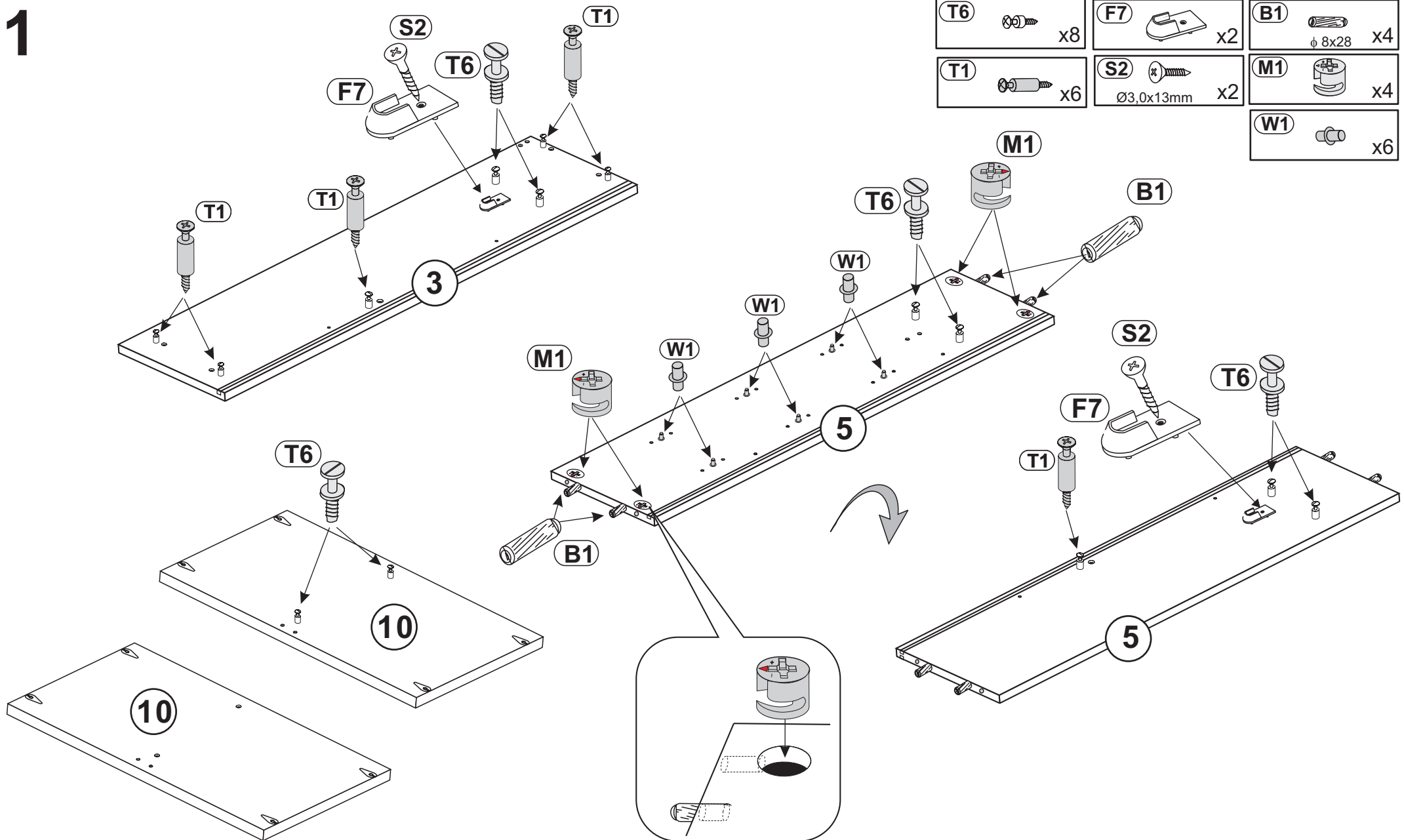

2

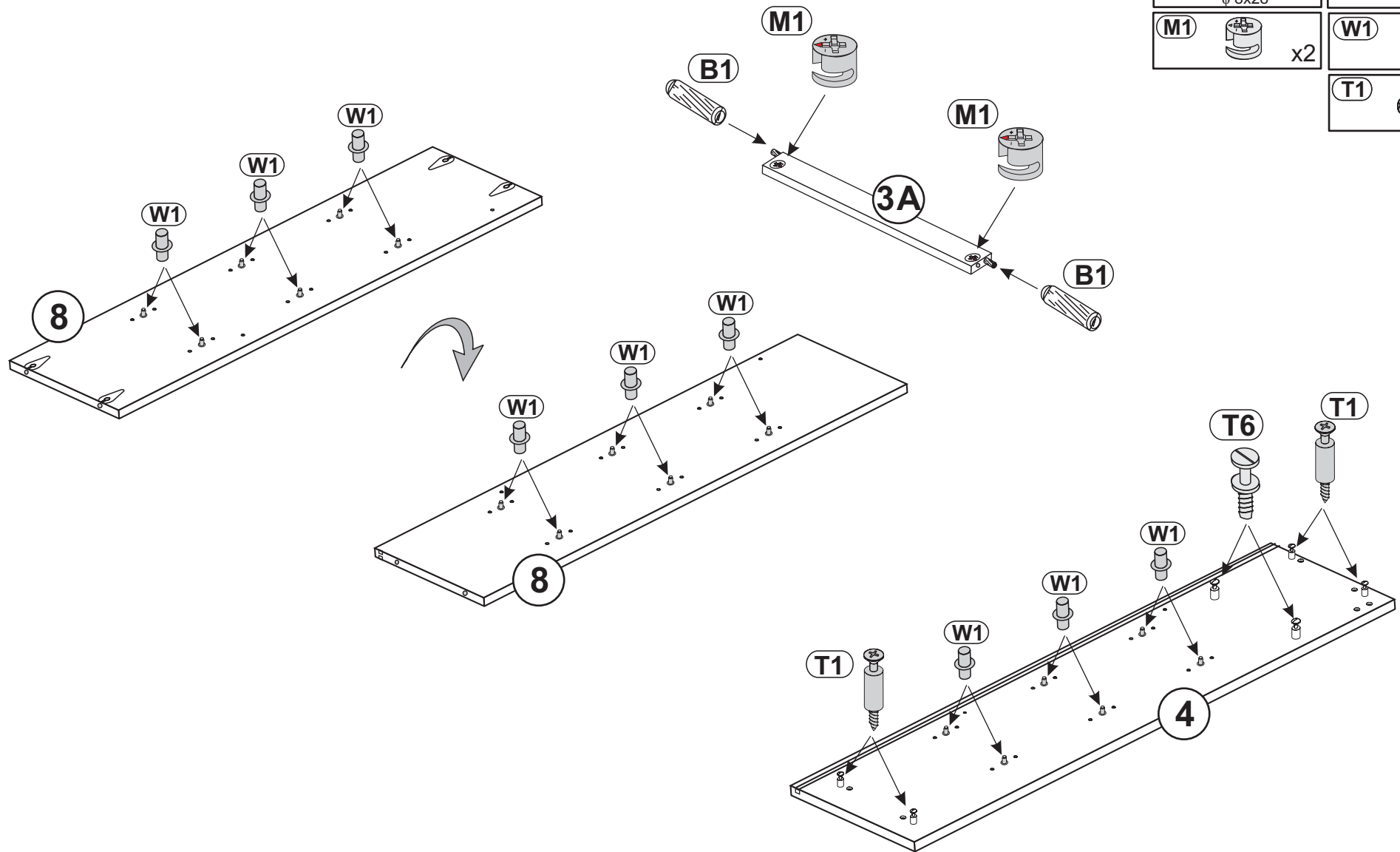



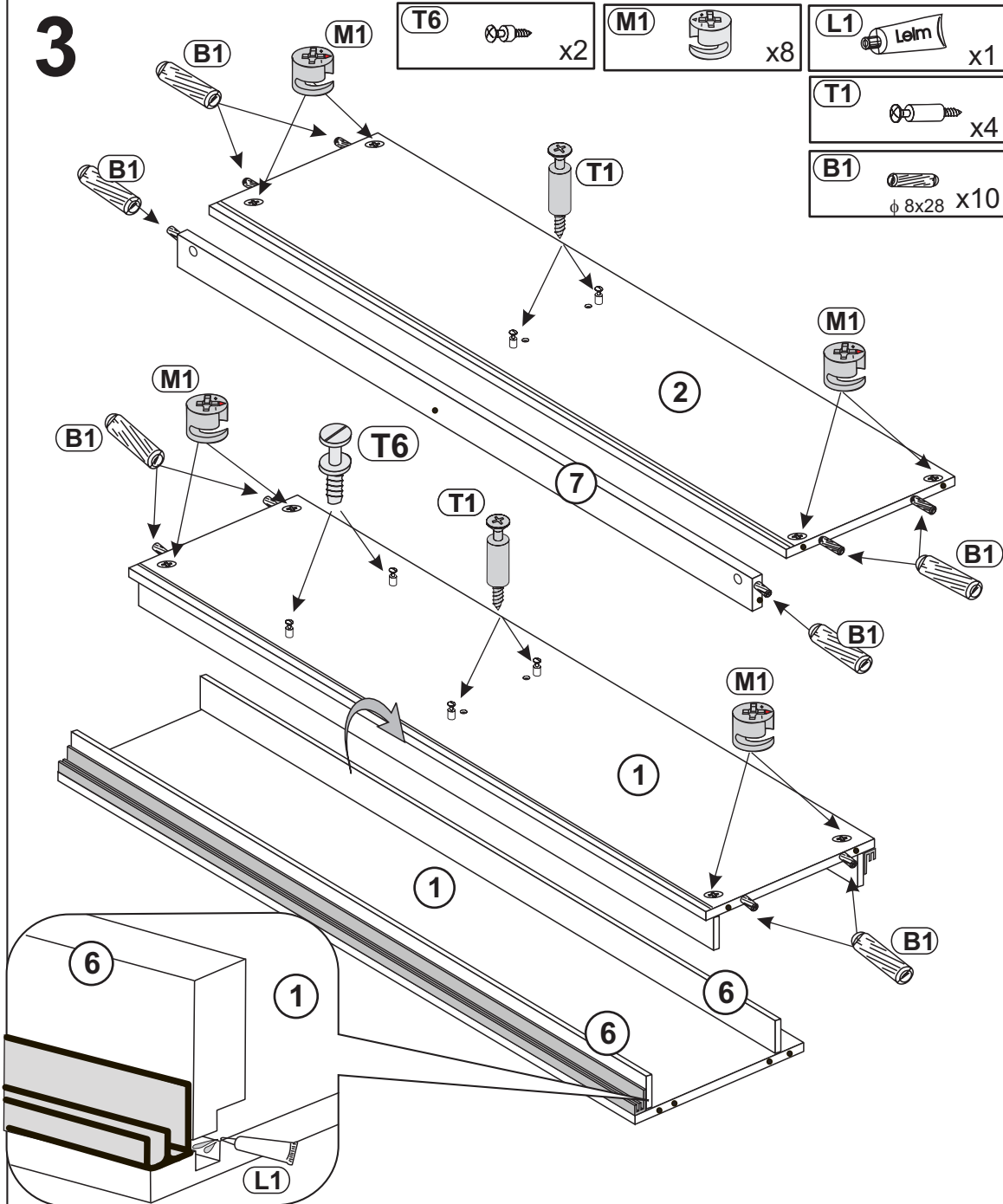

3

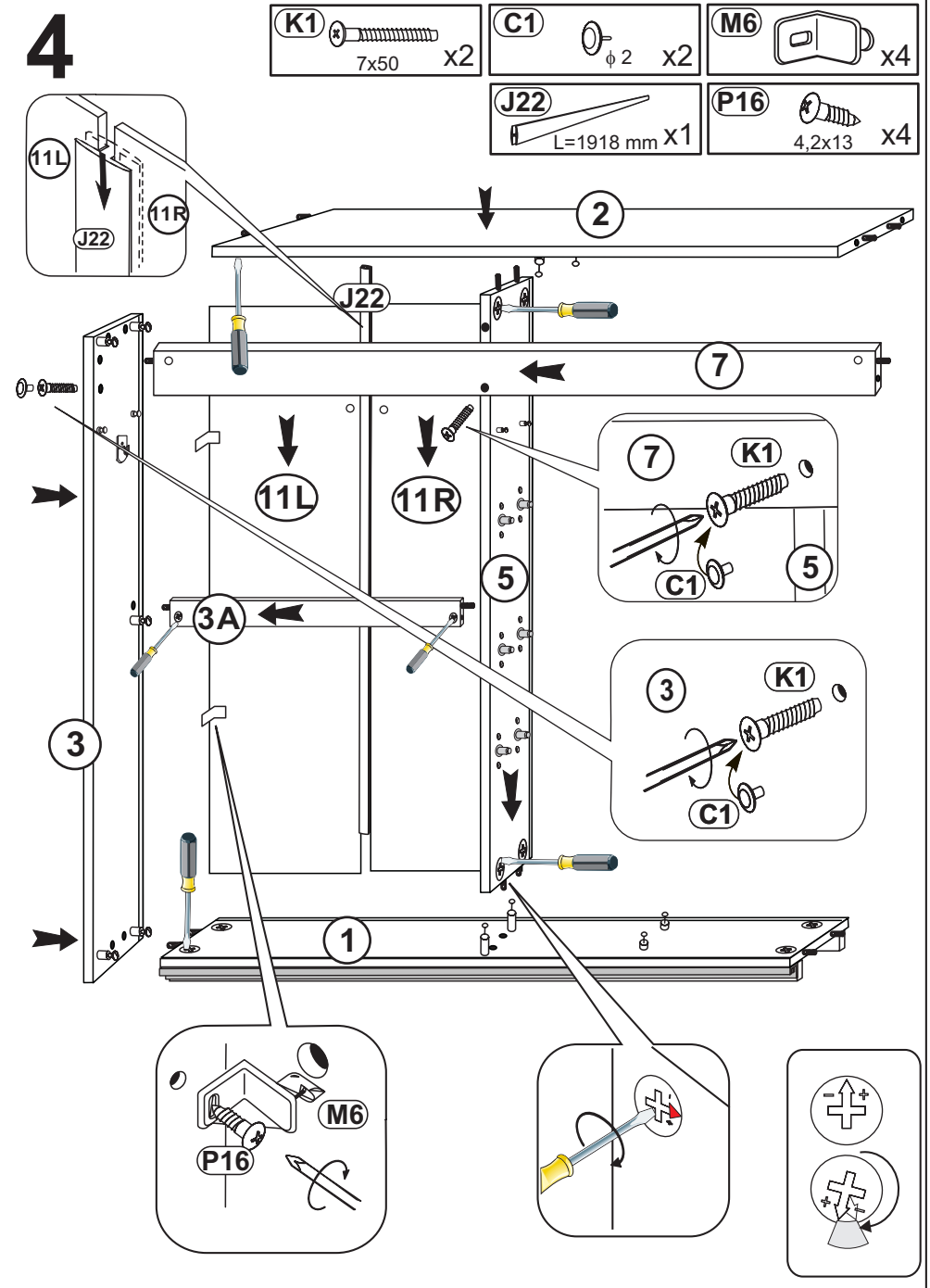

4





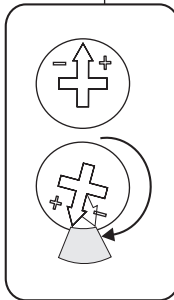
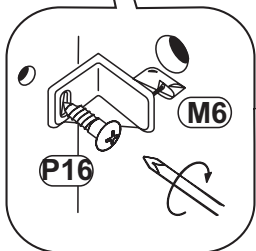
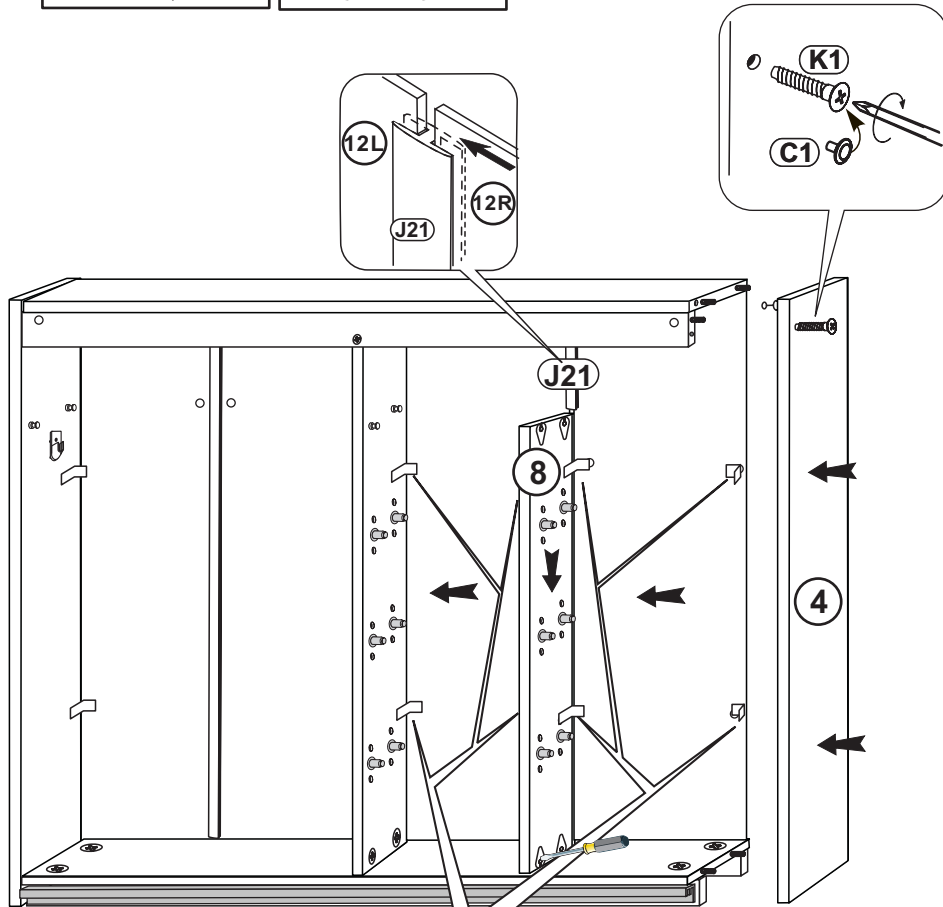

5

- K1**  Ø7x50mm X1
- P16**  Ø4,2x13mm X8
- J21**  L=330 mm X1
- C1**  φ2 X1
- M6**  X8



6

- S3**  Ø3,5x13mm X8
- M6**  X2
- P16**  Ø4,2x13mm X2
- L3**  L=970 mm X1

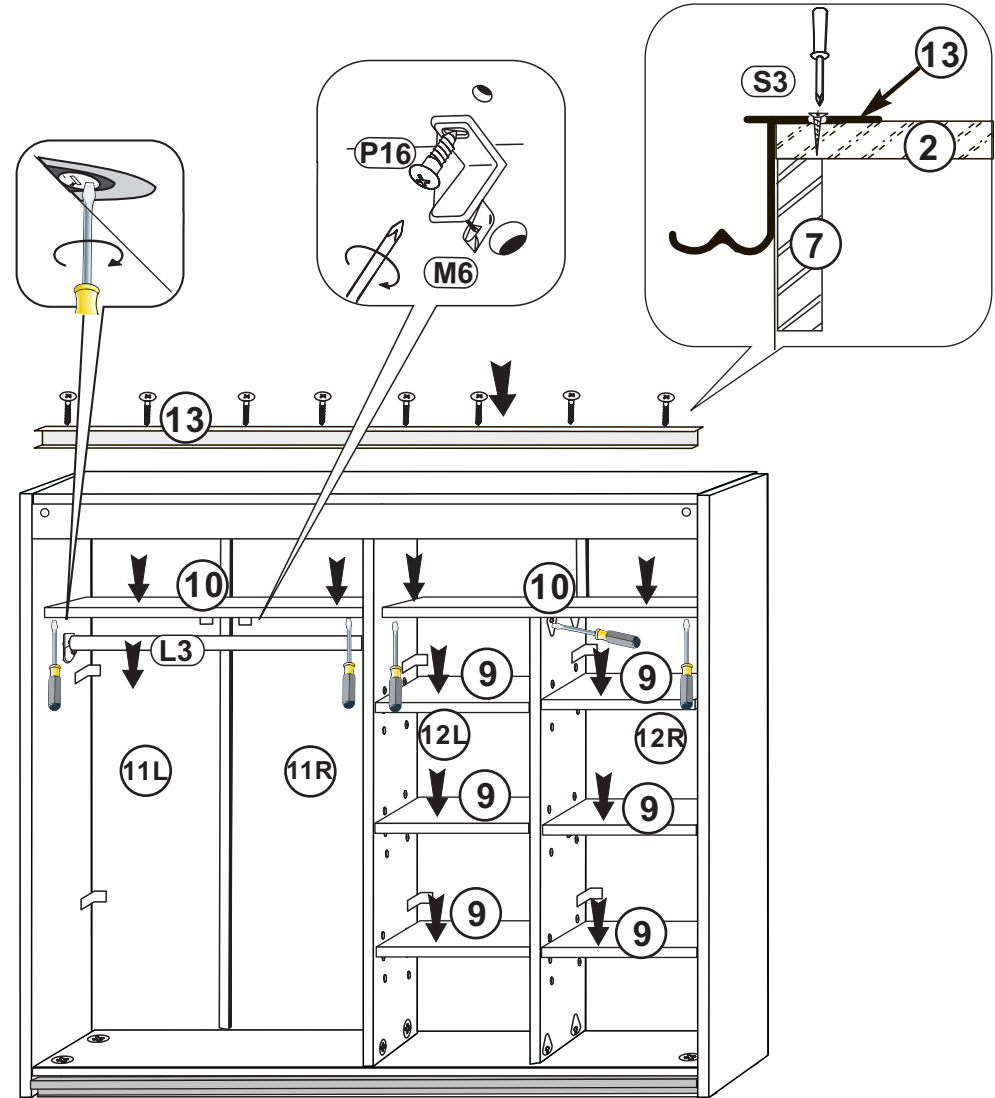

7

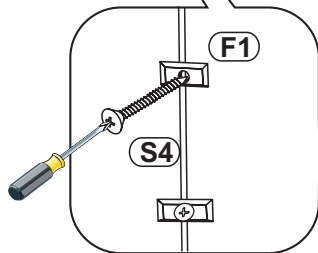
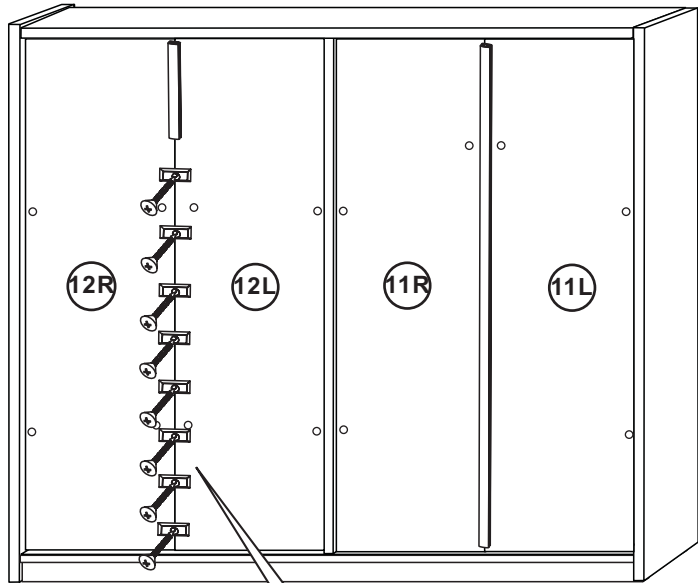
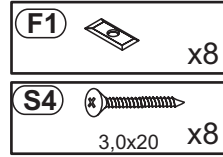

8

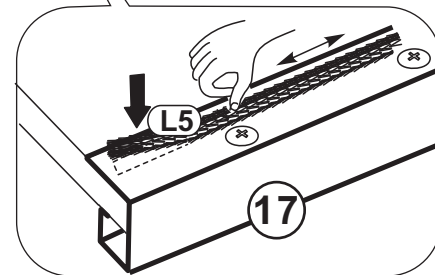
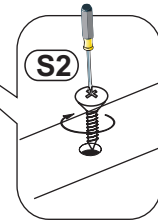
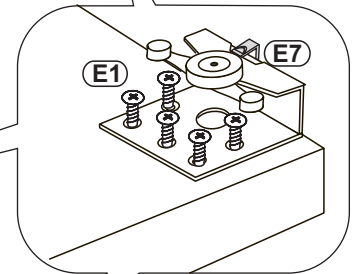
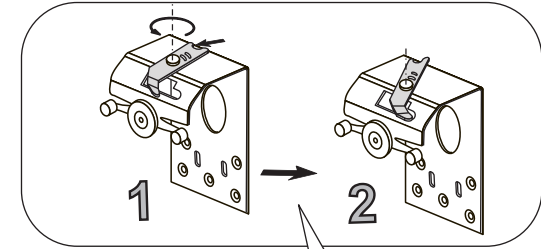
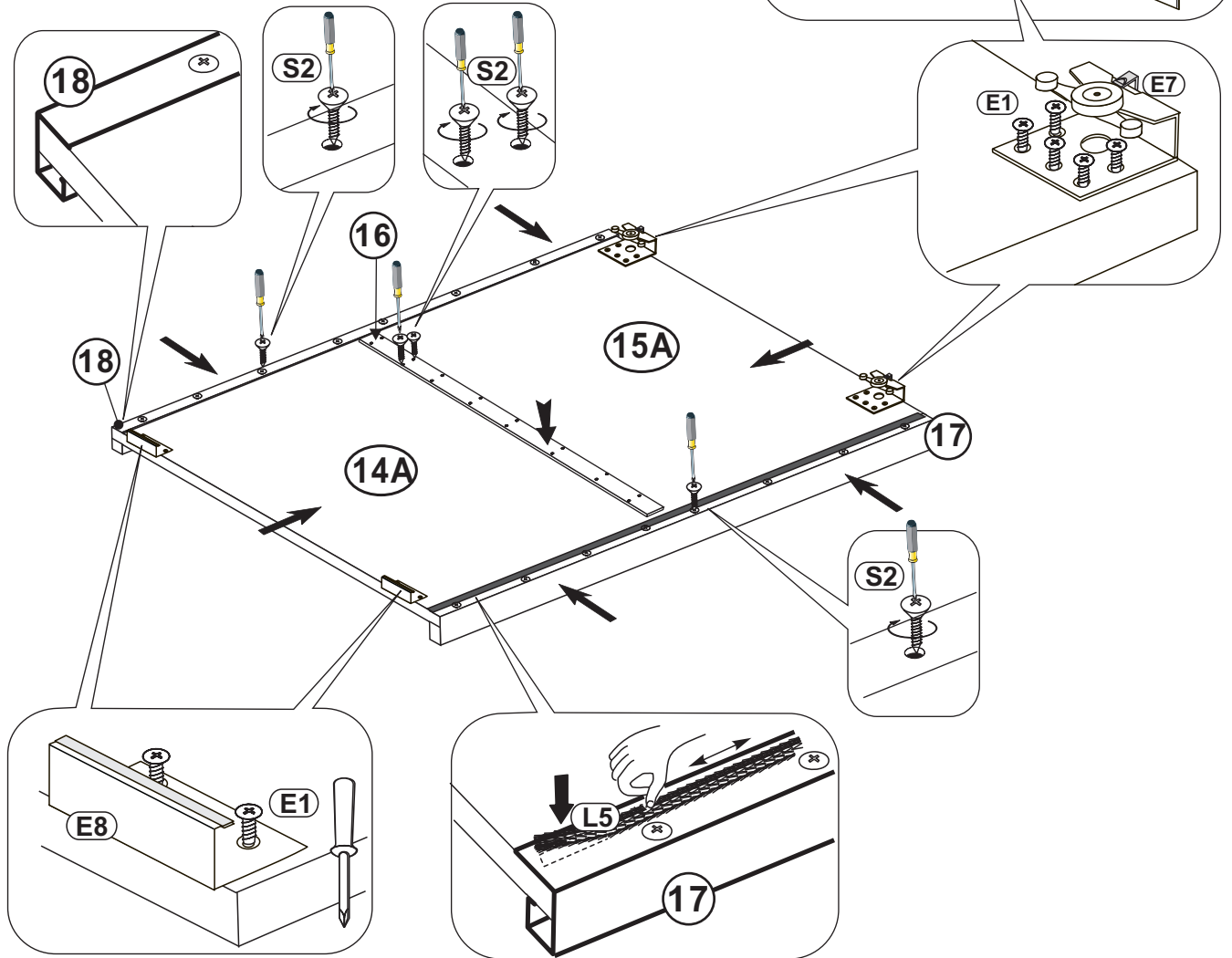
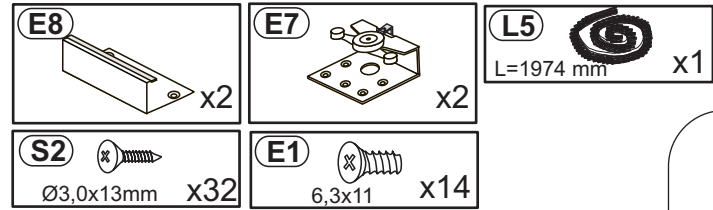

10

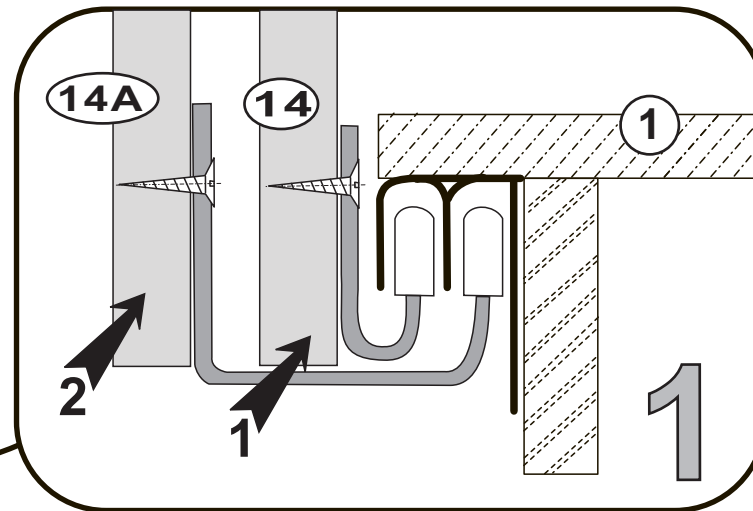
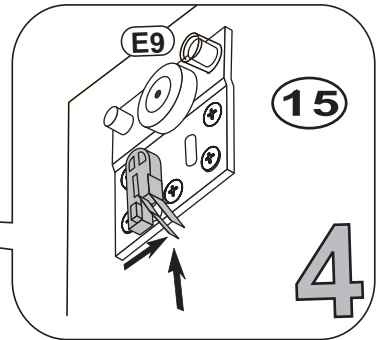
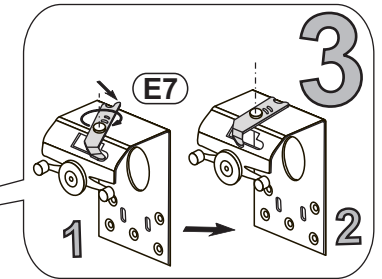
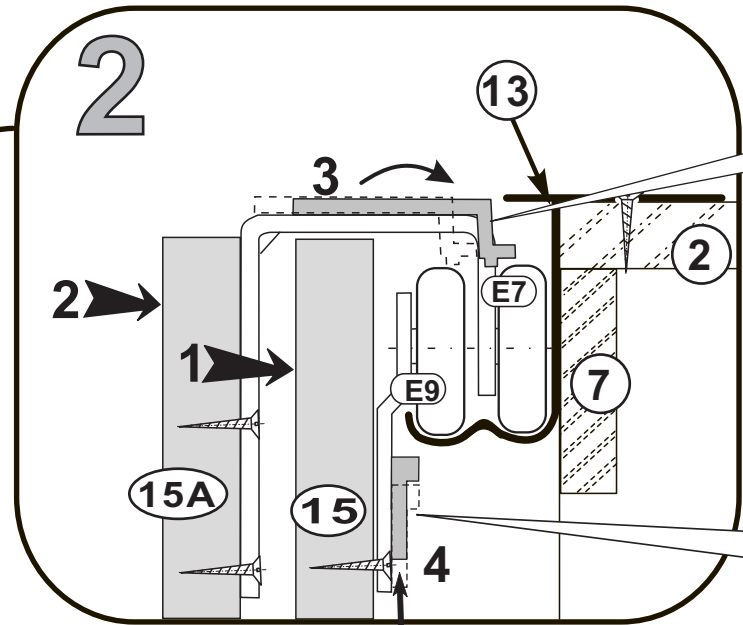
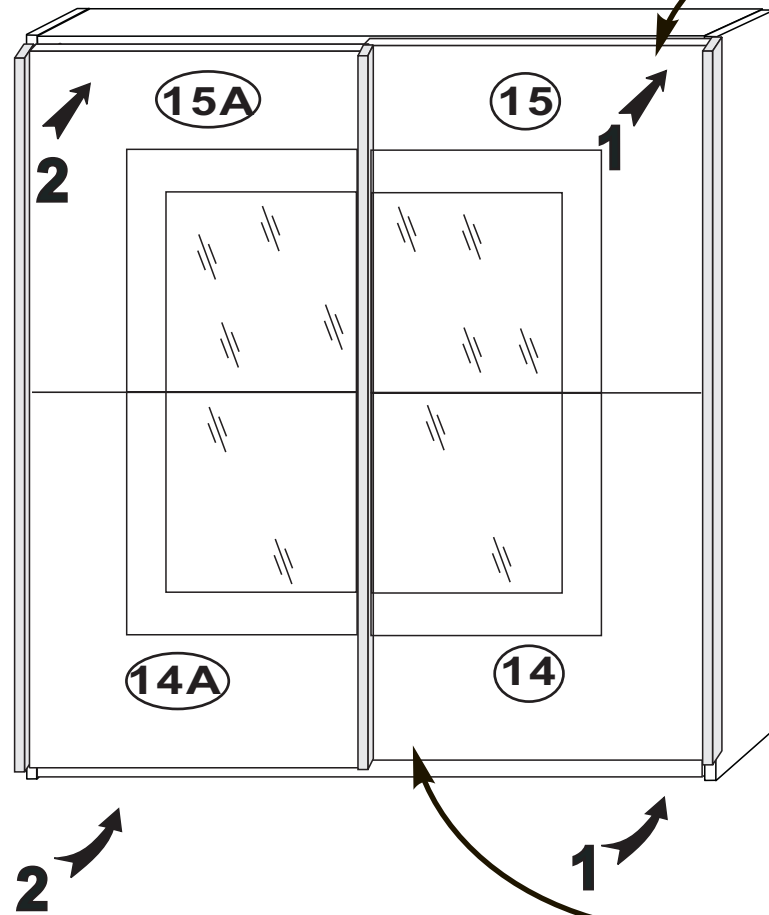

11

