

Modellname:
Nazwa modelu:

DOVER

Modellreihe:
Numer modelu:

SL -- 08

Type: 18
Typ: 18

Blatt Nr 1 von: 5
Strona 1 z: 5

MONTAGEANLEITUNG INSTRUKCJA MONTAŻOWA

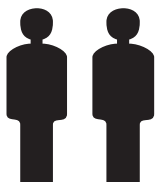

**2 Personen
2 Osoby**

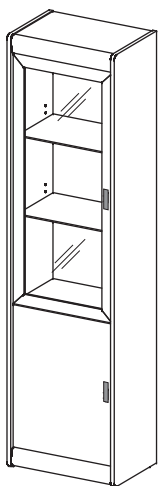
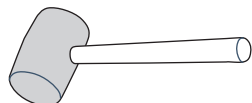
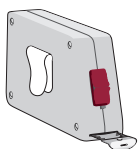

TYPE "L"

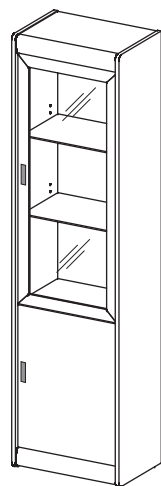

TYPE "R"

**MONTOWAĆ
NA ROZŁOŻONYM KARTONIE!**

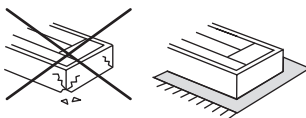

**Wskazówka dotycząca
pielęgnacji!**

Proszę czyścić tylko suchą
lub lekko wilgotną szmatką do kurzu.
Nie używać żadnych środków szorstkich!
Maksymalne obciążenie półek w kg:

Stärke/Gr. Länge/Dł. mm	Spanplatte/Płyta		
	15	18	22
0<400			
401<600	40	40	40
601<800	24		
801<1000	15	30	

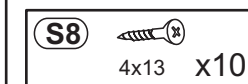
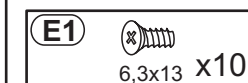
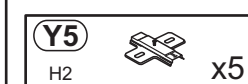
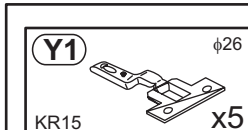
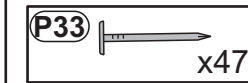
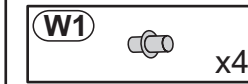
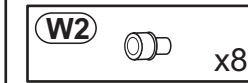
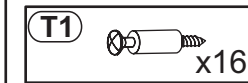
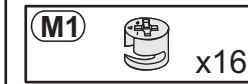
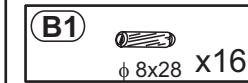
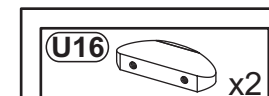
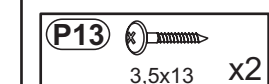
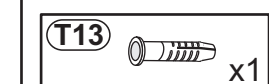
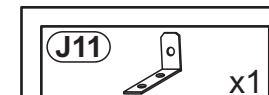
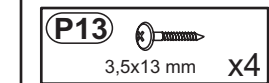
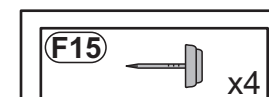
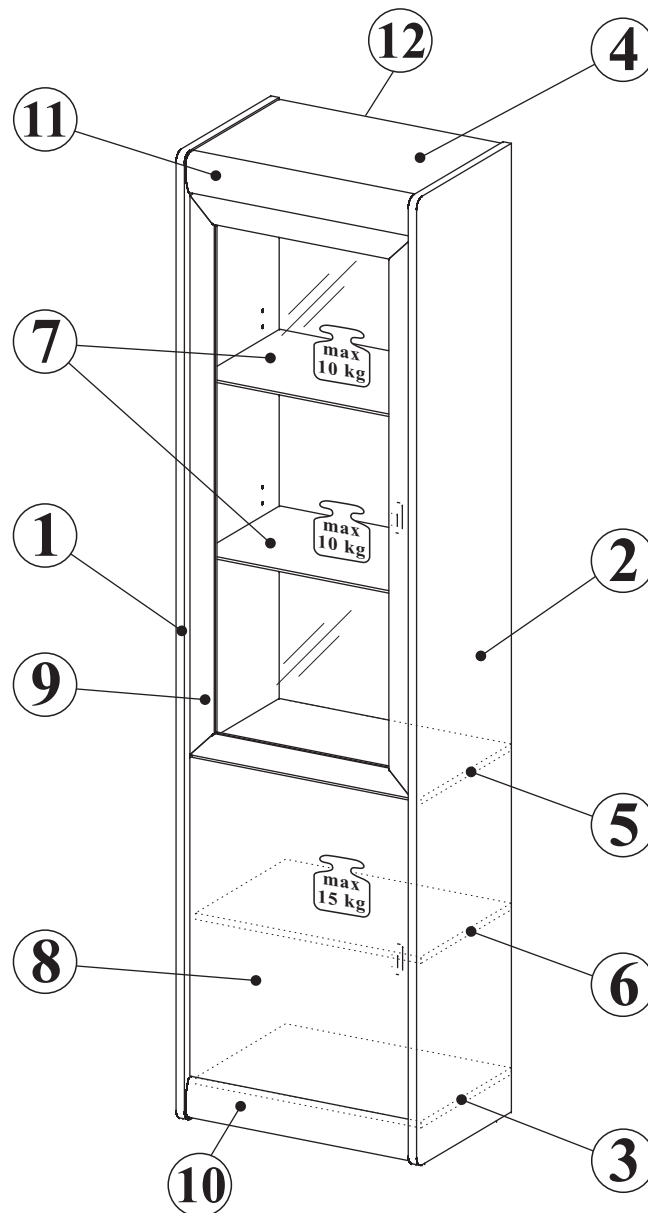

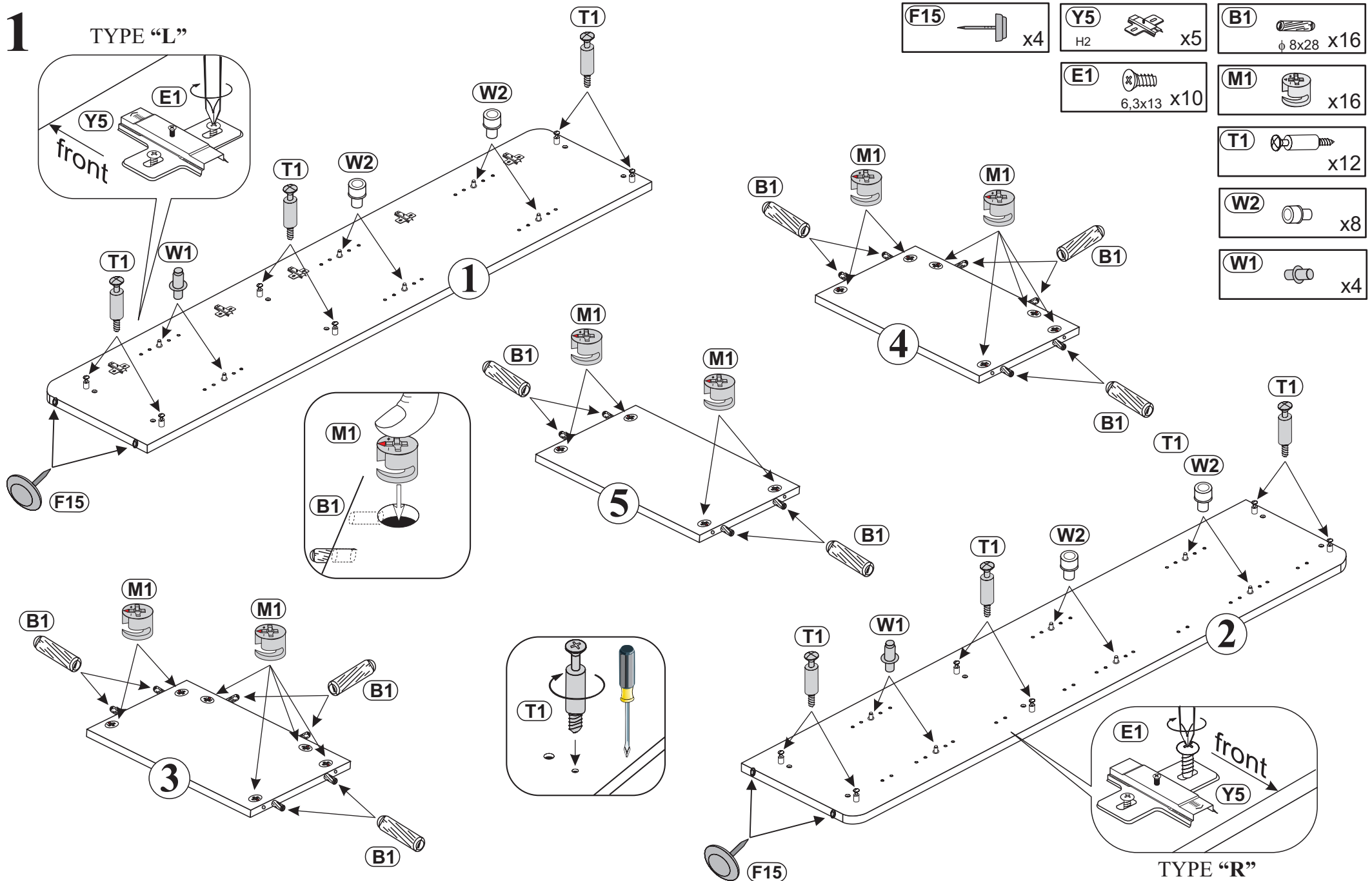

1

TYPE "L"



2

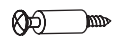

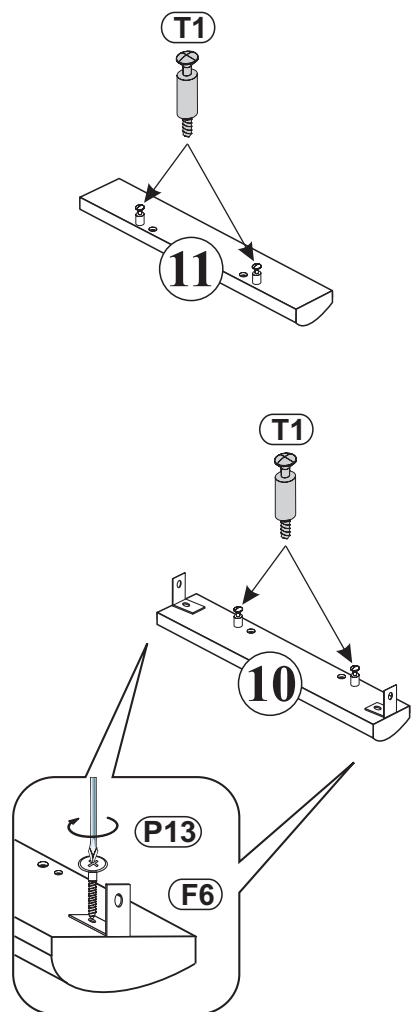

- F6**  x2
- P13**  3,5x13 mm x2
- T1**  x4

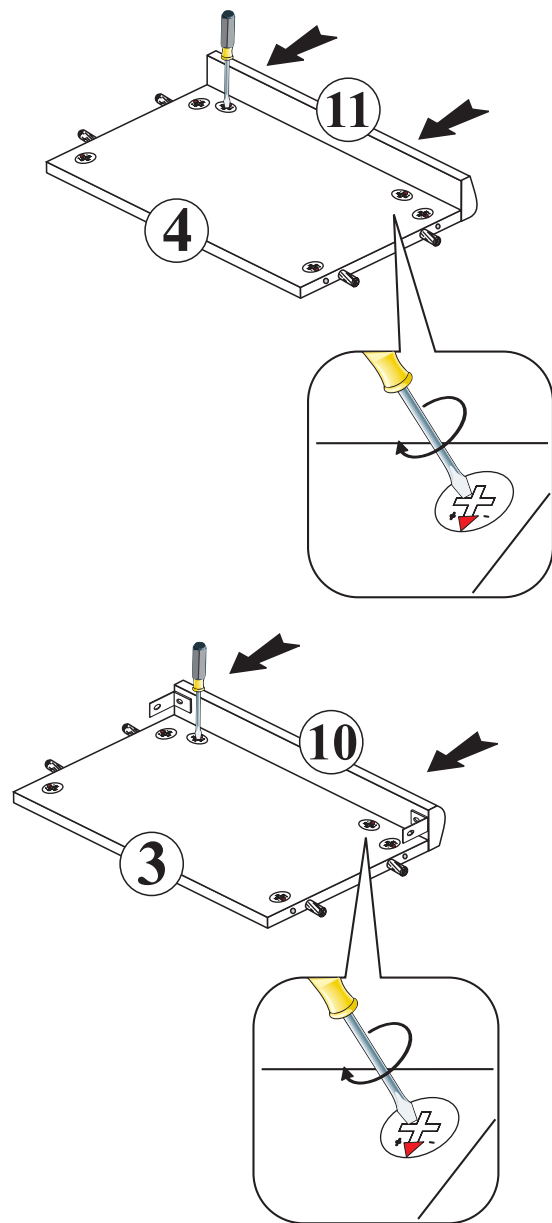

3

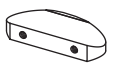

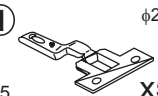
4

- U16**  x2
- A2**  M4x22 x4
- Y1**  $\phi 26$ KR15 x5
- S8**  4x13 x10

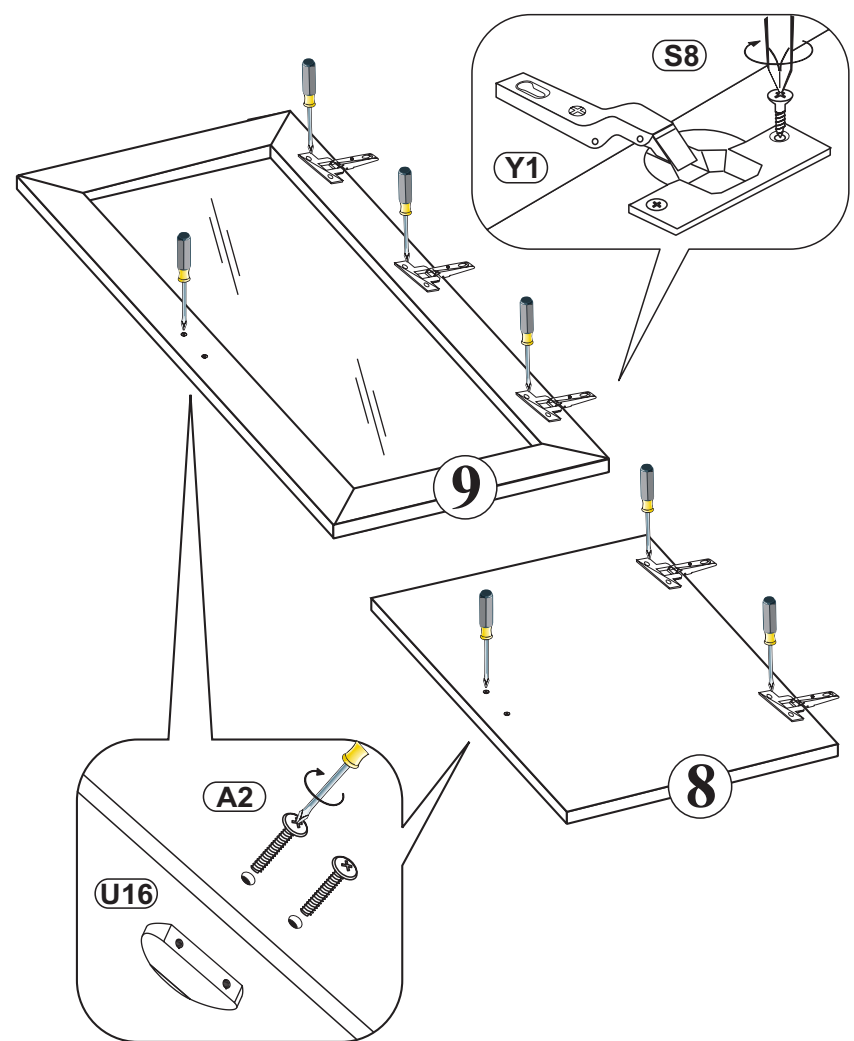

5

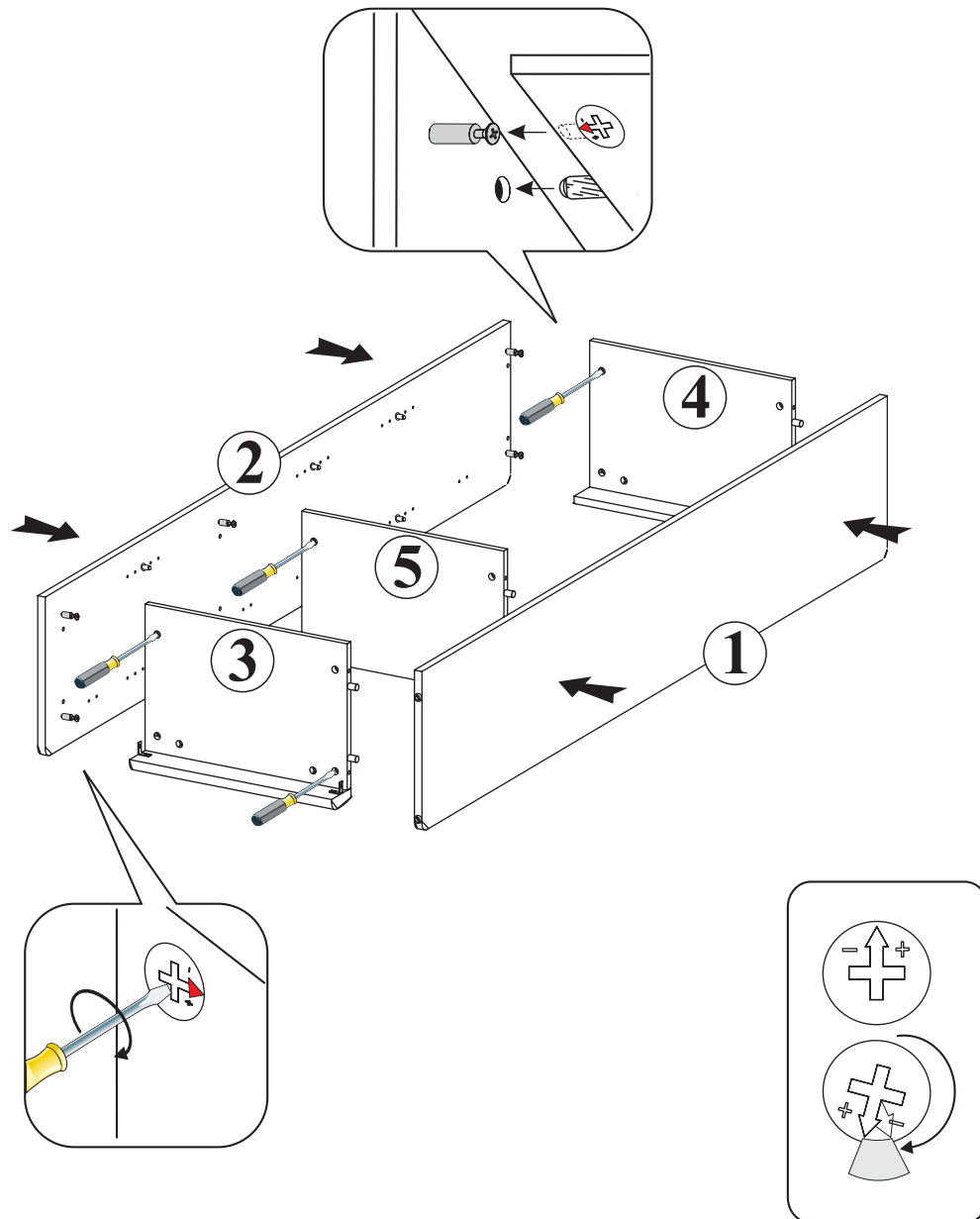

6

P13 3,5x13 mm x2

P33 x47

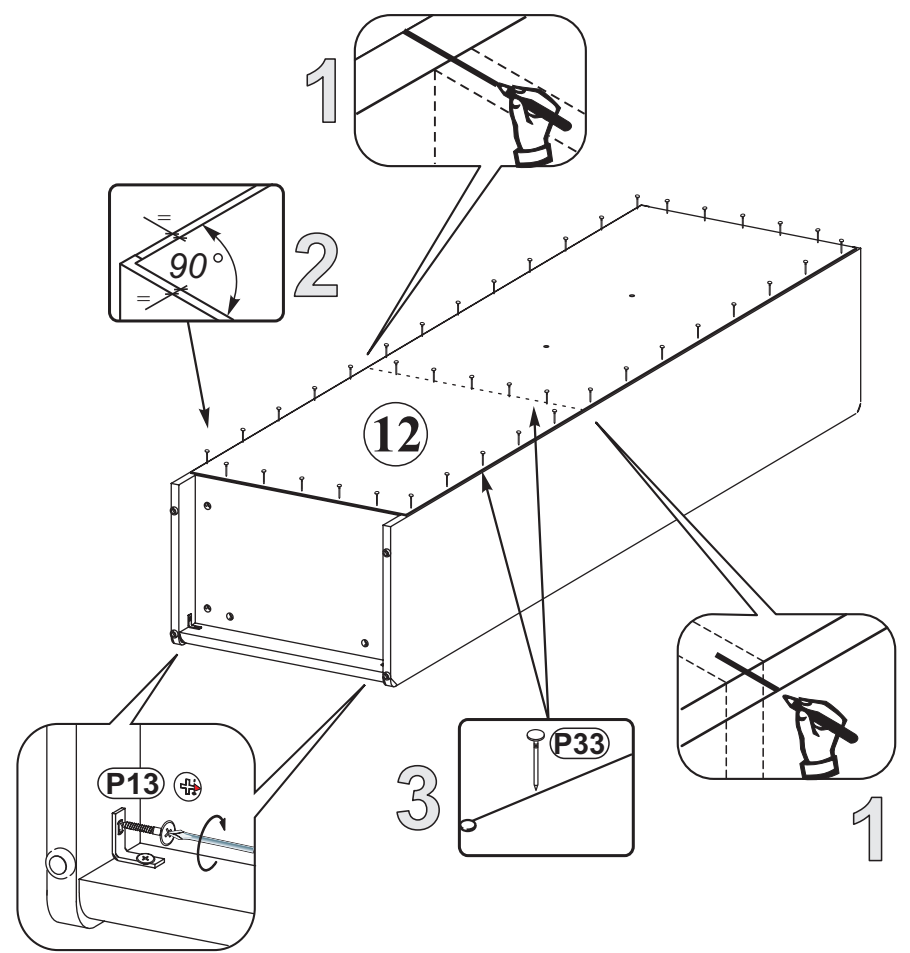

7

