

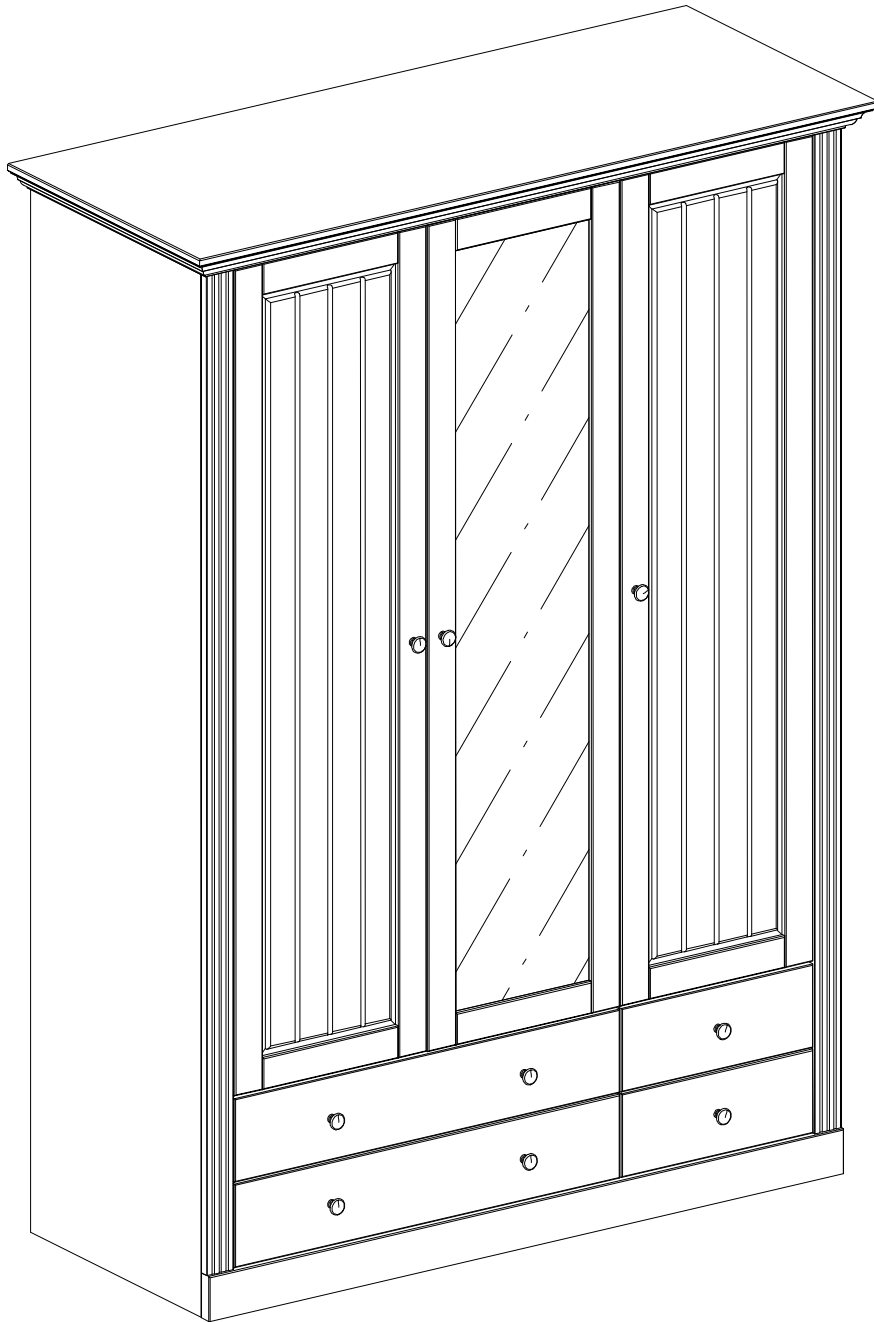

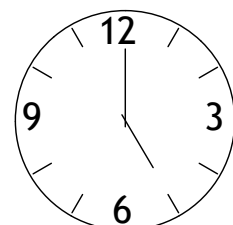

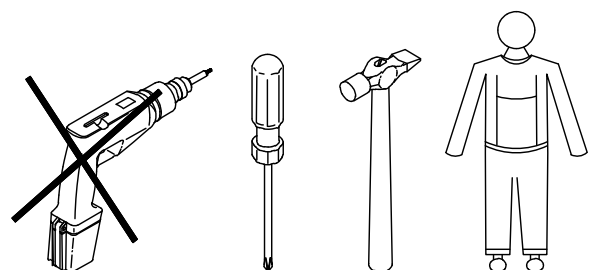

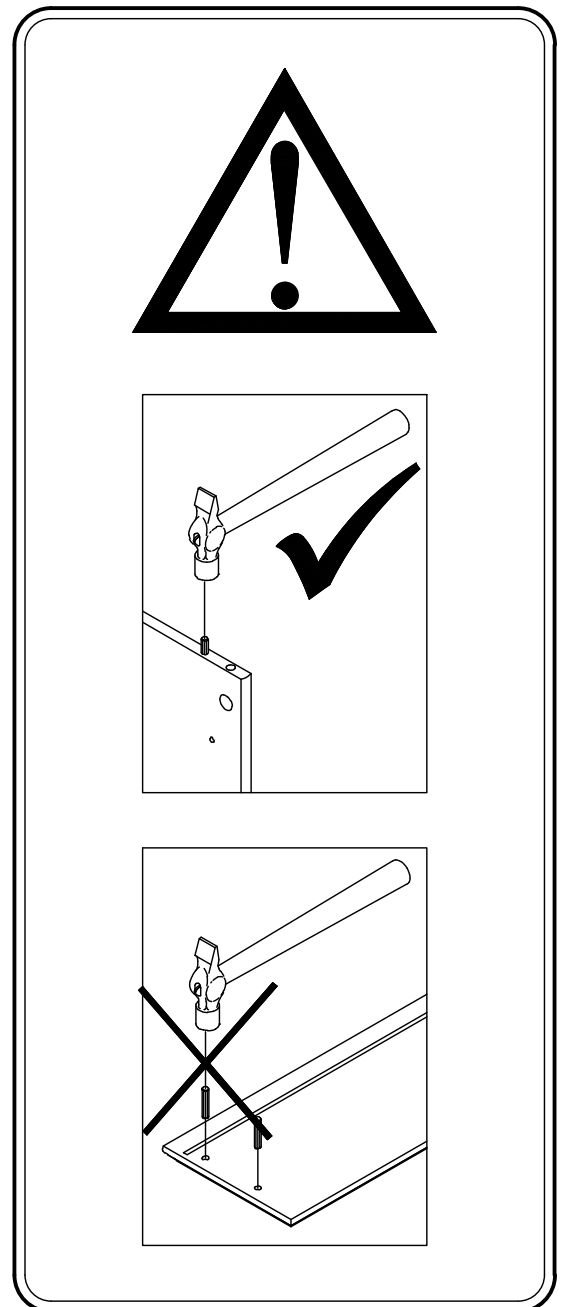

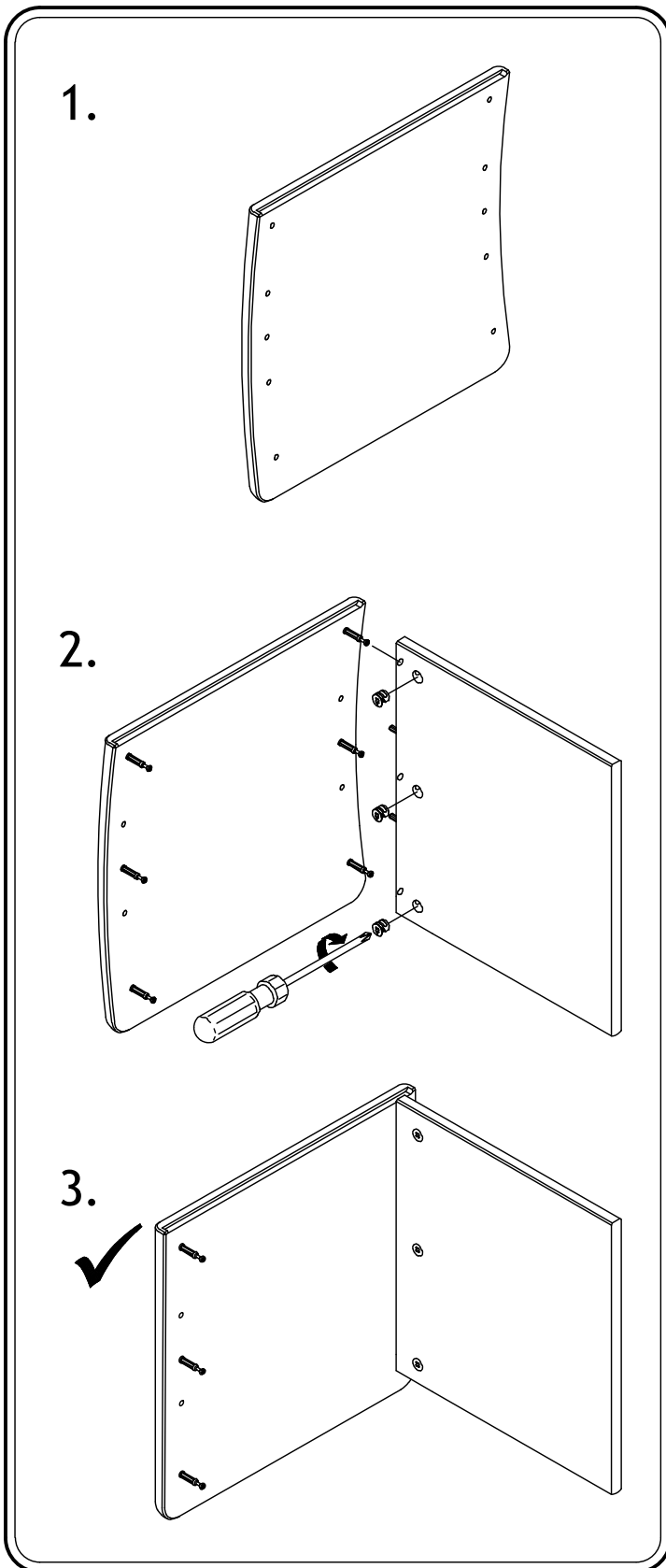
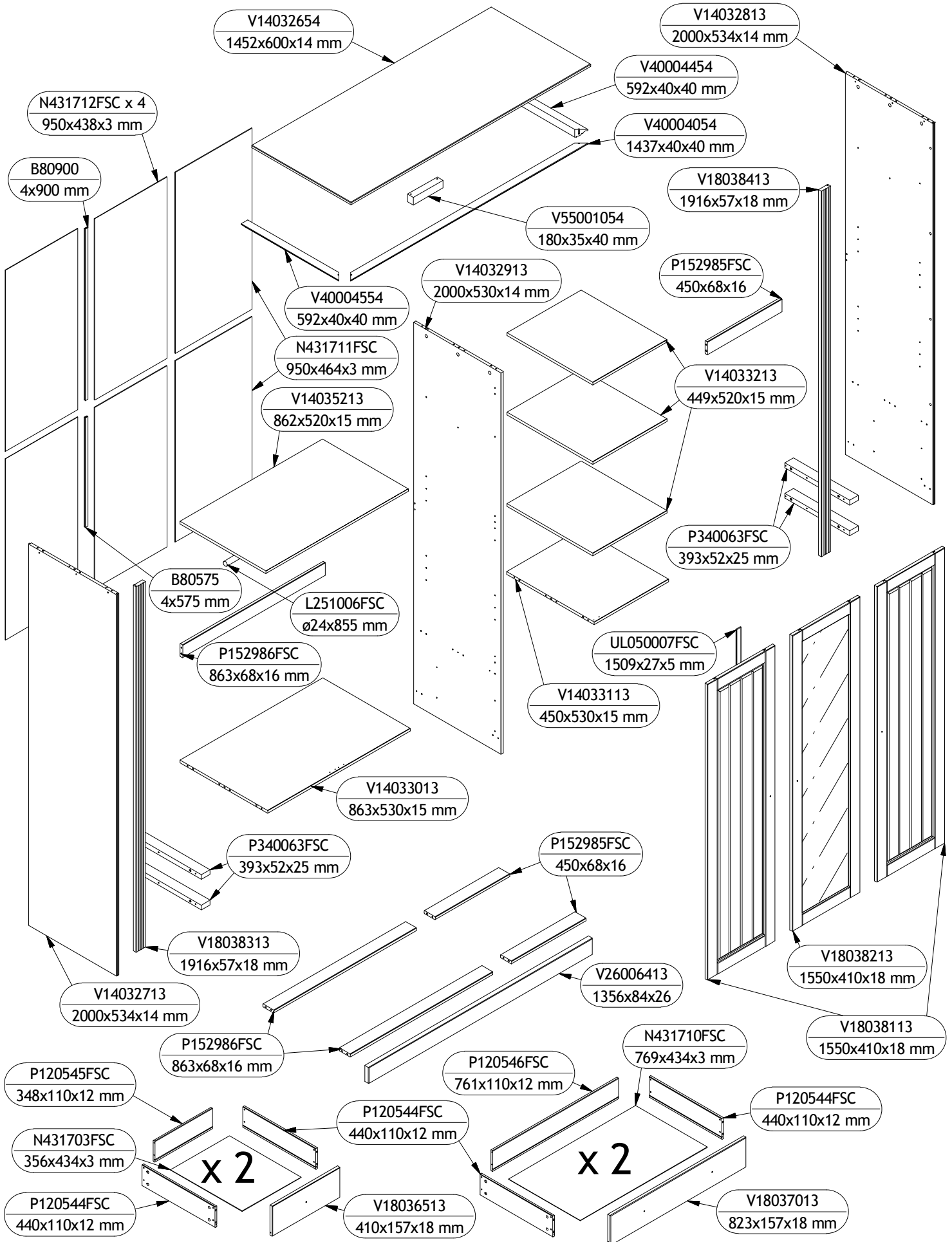
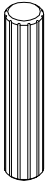
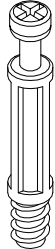
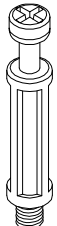

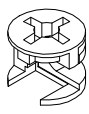





31711213

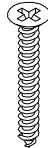

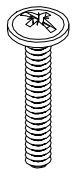
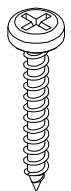
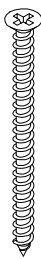
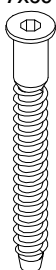

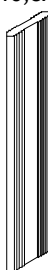
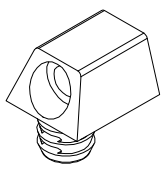
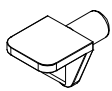
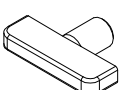
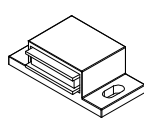

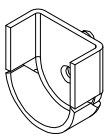
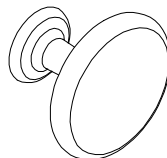
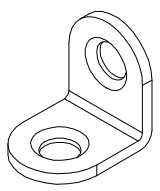
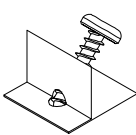
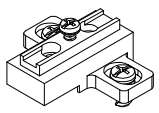
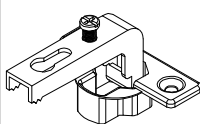
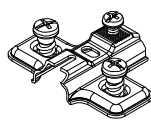
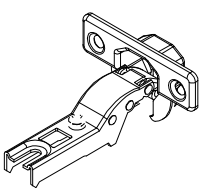
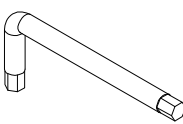
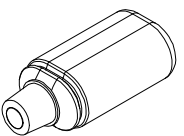
<p>BA10400 x 40 ø6x30</p> 	<p>BA10602 x 37 ø5/8x34</p> 	<p>BA10617 x 12 M4x5,5</p> 	<p>BA10590 x 33 ø15x9,5</p> 	<p>BA10596 x 16 ø12x9,5</p> 	<p>BA10020 x 100 ø1,2x16</p> 	<p>BA10619 x 10 M4xø5x12</p> 
<p>BA10250 x 11 6,3x11</p> 	<p>BA10623 x 8 M4x6</p> 	<p>BA10158 x 12 ø3,5x12</p> 	<p>BA10106 x 22 ø3,0x12</p> 	<p>BA10050 x 27 ø3,5x15</p> 	<p>BA10110 x 6 ø3,5x25</p> 	<p>BA10045 x 16 ø3,5x35</p> 
<p>BA10223 x 9 M4x22/23</p> 	<p>BA10144 x 11 ø4,5x30</p> 	<p>BA10152 x 2 ø4,5x50</p> 	<p>BA10307 x 8 7x60</p> 	<p>BA10985 x 2 W-2 25,4 mm</p> 	<p>BA10981 x 16 3x16,5x80</p> 	<p>BA10336 x 11 22x12/ø11x10</p> 
<p>BA10848 x 16 ø5x7</p> 	<p>BA10831 x 5 ø5</p> 	<p>BA107081 x 6 40x19</p> 	<p>BA10709 x 6 35x12</p> 	<p>BA10730 x 2 ø25xø5</p> 	<p>BA10501 x 9 ø30x23,5</p> 	<p>BA10801 x 5 20x20x16x2</p> 
<p>BA10833 x 4 15x15x10</p> 	<p>BA10536 x 6</p> 	<p>BA10535 x 6</p> 	<p>BA10539 x 3</p> 	<p>BA10508 x 3</p> 	<p>BA10680 x 1 4 mm</p> 	<p>I10882 x 1</p> 
<p>B2133041 x 4 450 mm</p> 