

VIK-01 VIKI - KOMODA

► 150 ▲ 86 ▼ 42

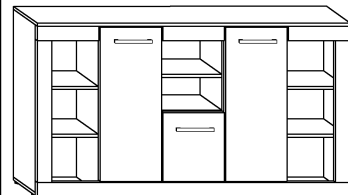

x 16



(a)

x 22



(b)

x 6



(c)

x 28



(d)

x 4



(e)

x 2



(f)

x 6



(g)

x 4



(h)

x 36



(i)

x 3



(k)

x 6



(l)

x 20 (3,5x16)



(m)

x 130



(n)

x 1



(o)

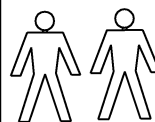

50 min

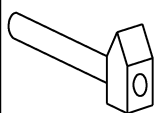

① - FAZY MONTAŻU

Ⓐ - OZNACZENIE ELEMENTÓW

Ⓐ - OZNACZENIE AKCESORIÓW

①

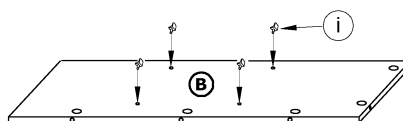
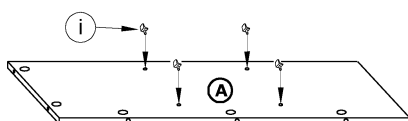

②

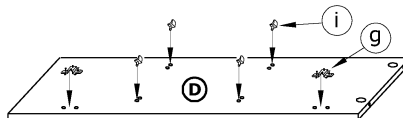
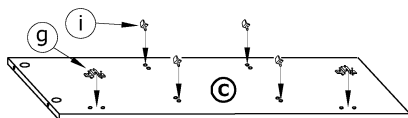

③

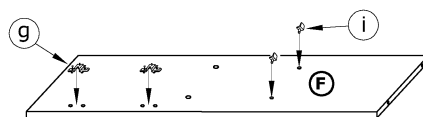
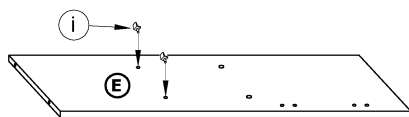

④

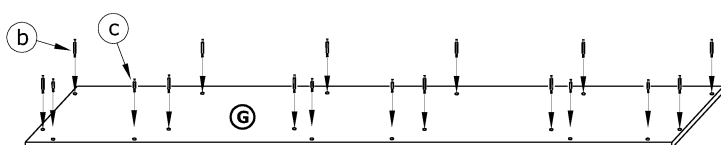

⑤

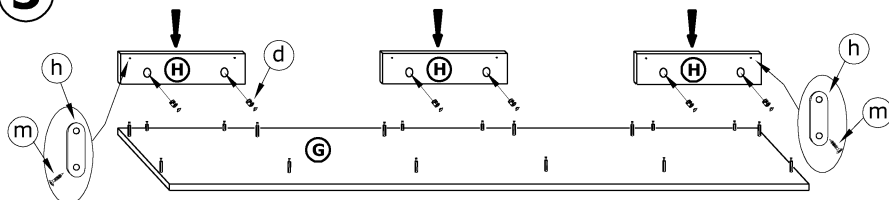

⑦

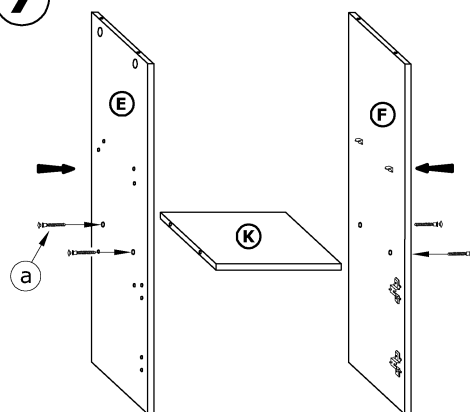

⑥

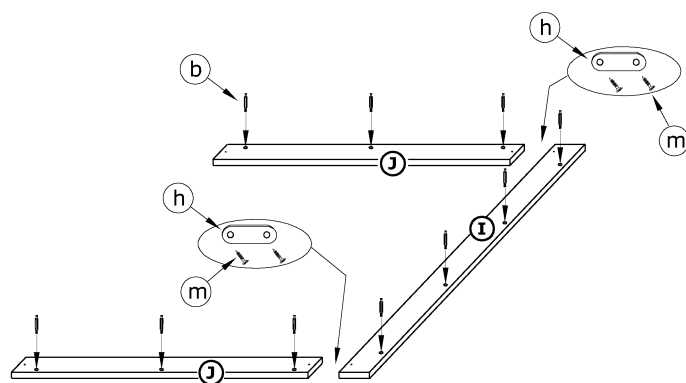

8

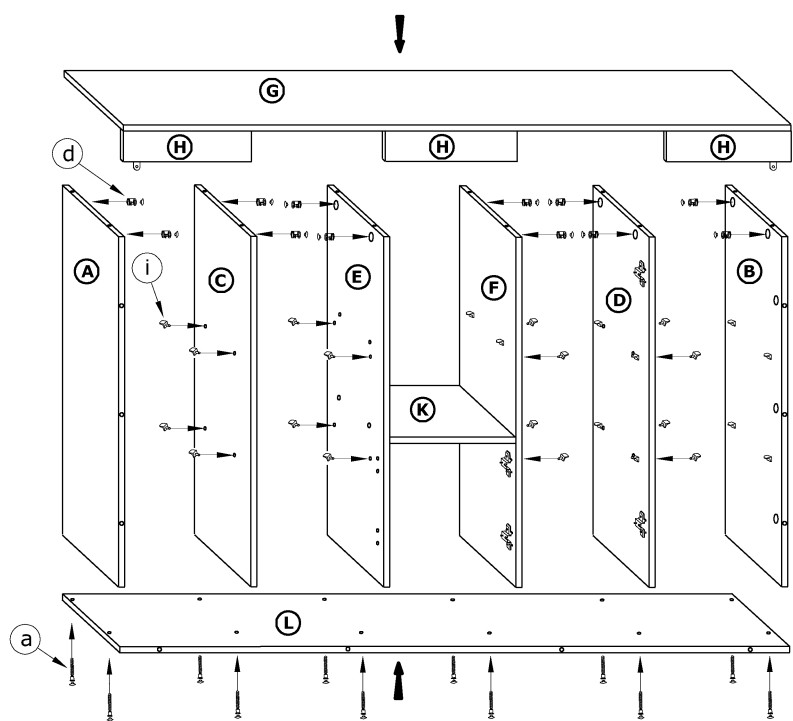

9

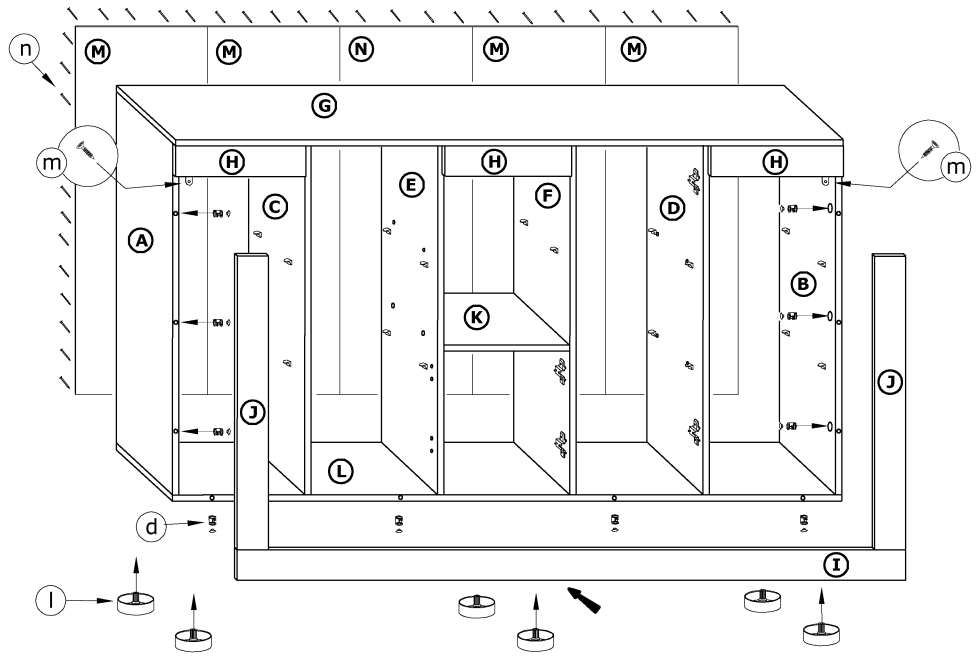

10

