

980721

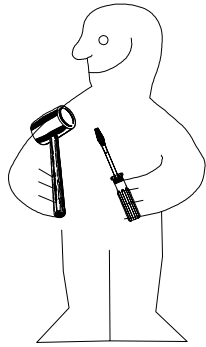

1.



2.

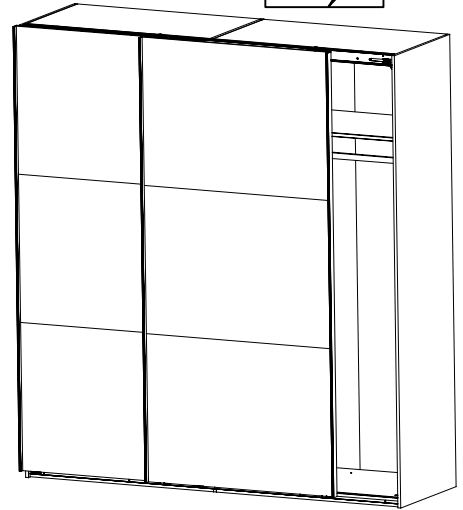
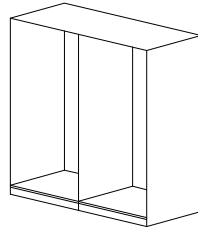



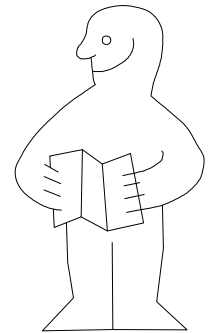
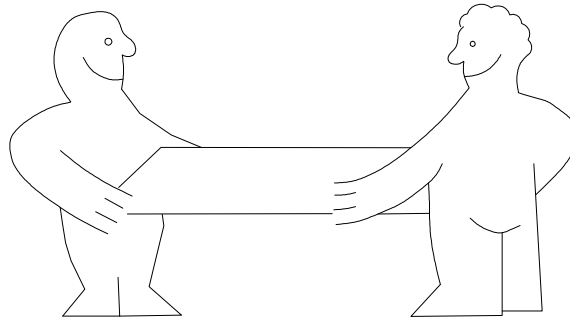
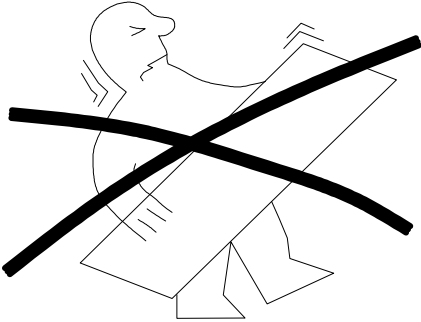

HSP 200

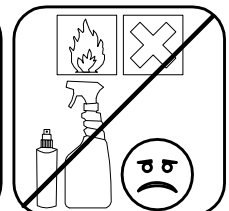
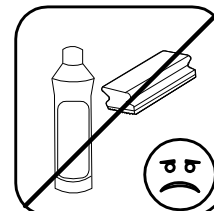
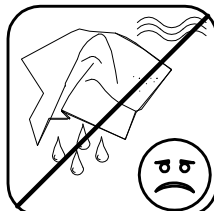
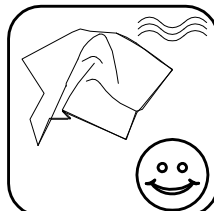
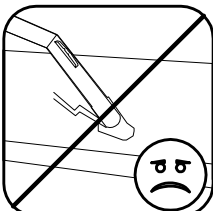
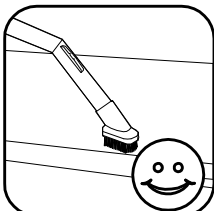
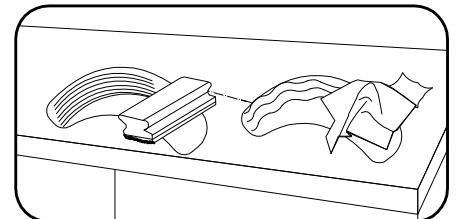
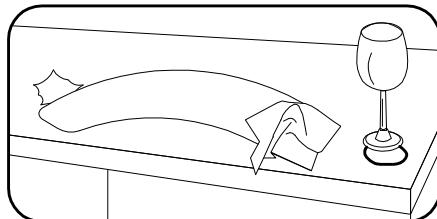
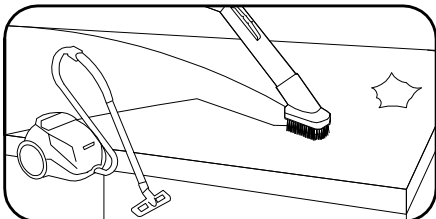
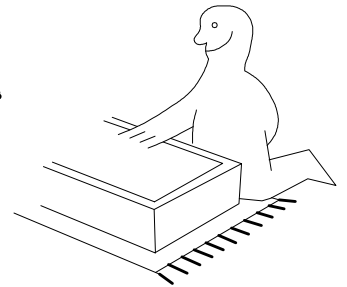
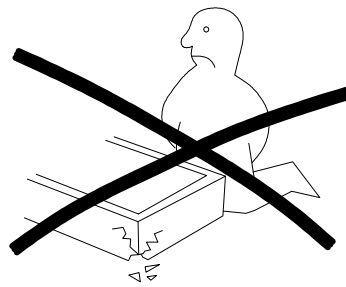
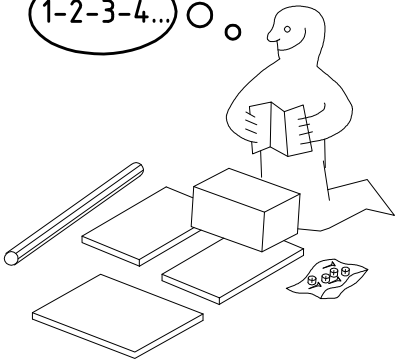

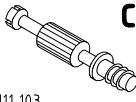



1-2-3-4... ○



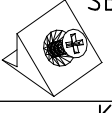

 111 xxx	A1 16x
 111 103	C 8x
	F3 4x

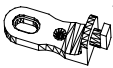
 111 xxx	S0 10x
 111 xxx ø12	V12 10x
 121 370 3,5 x 15 mm	G1 28x



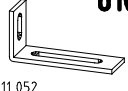

 117 002	K2 4x
	SBV 16x
 100cm 112 400	K10 2x

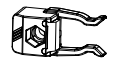
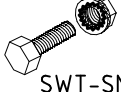

 111 611	J2 6x
 6,3 x 10,5 mm 112 055	T1 24x
 111 607	L8 8x

 111 052	o10 1x
 4 X 15mm 121 120	SP15 3x

1x **FPK**
1453/1940/2430/2920/3408

1x **SWT-LP**
1453/1940/2430/2920
/3410 SY

 121 xxx	SWT-ST 2x
 M4 x 13 mm 121 xxx	SWT-SM5 2x
 M4 x 13 mm 121 xxx	GH13 4x
 M4 x 10 mm 121 xxx	G43 4x
 3,5 x 35 mm 121 375	G14 2x

 121 004	SWH-SKL 1x
 3,5 x 22 mm 121 004	SWH-SKR 1x
	G24 7x

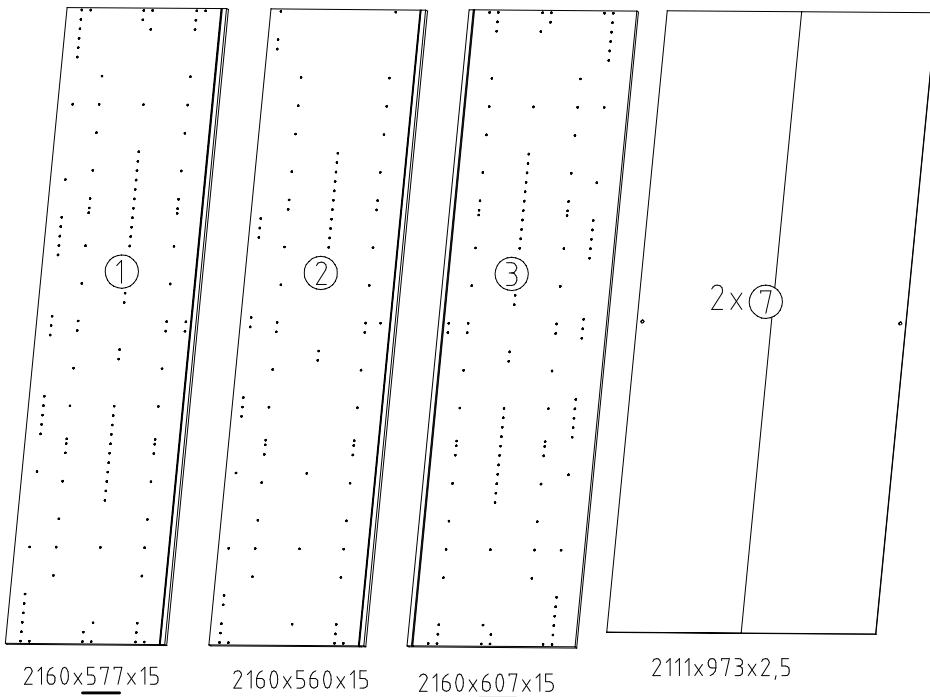
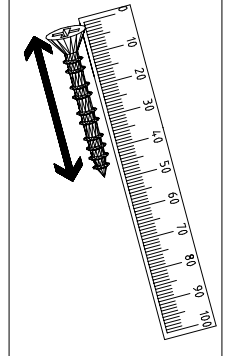
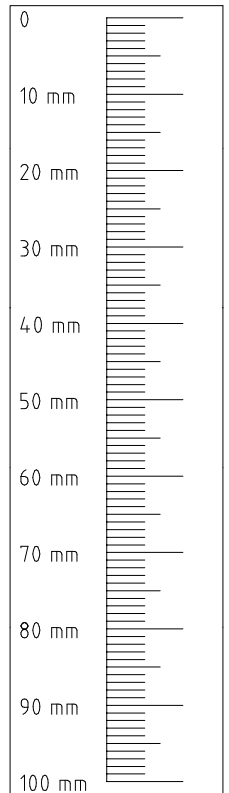
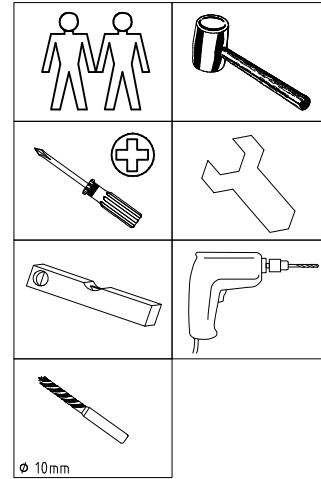

1

3,5 x 15 mm

G1

S0

A1

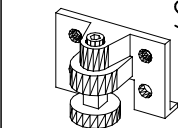
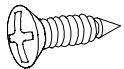

121 370

111 xxx

111 xxx

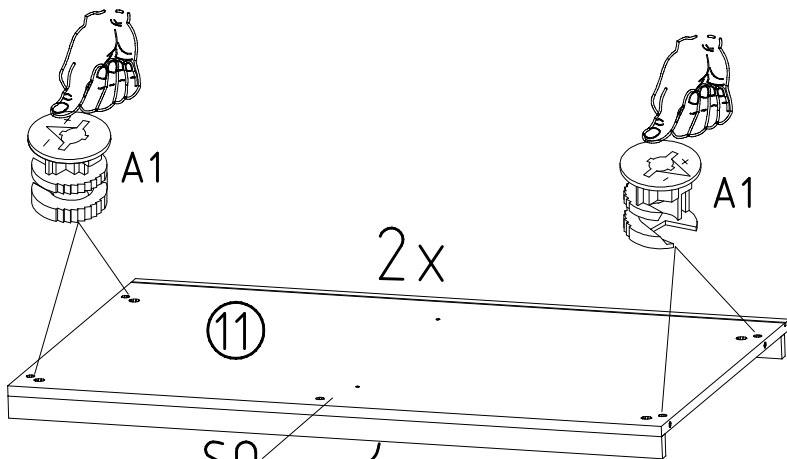

2x

11

S0

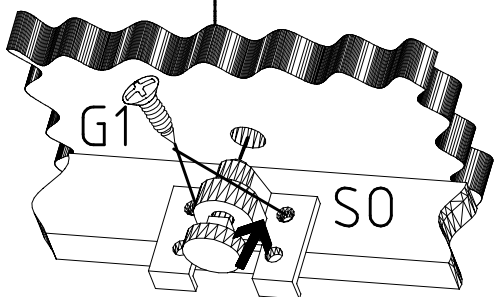

G1

S0

2

A1

111 xxx

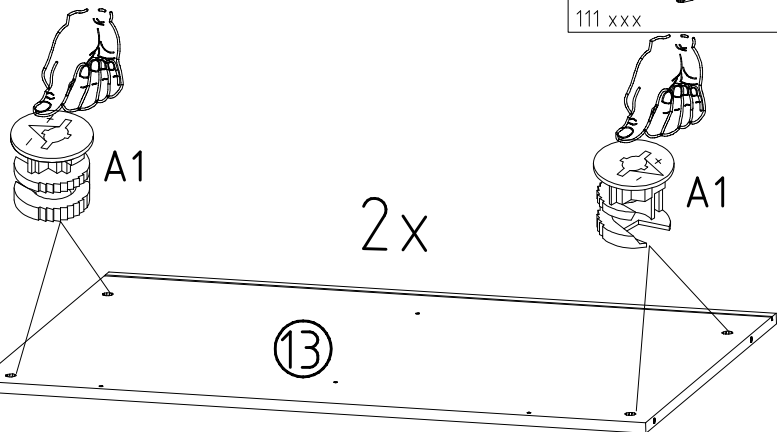

2x

13

3

F3

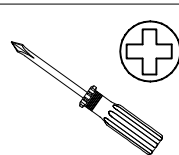

6,3 x 10,5 mm

T1

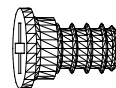

112 055

3,5 x 15 mm

G1

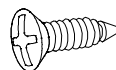

121 370

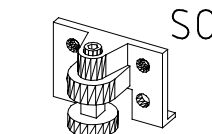

S0

111 xxx

F3

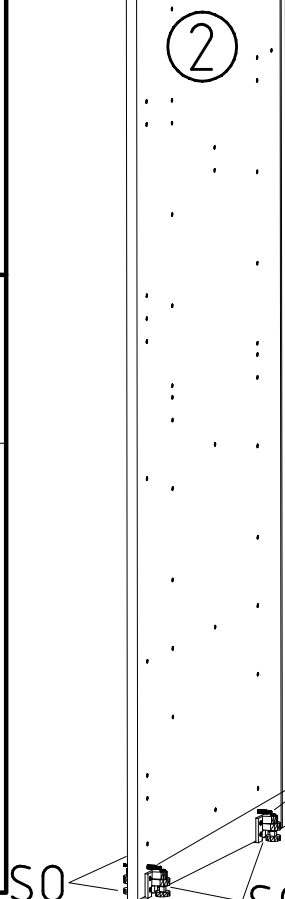
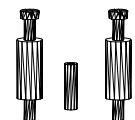

2

F3

S0

S0

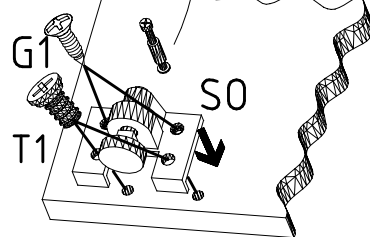
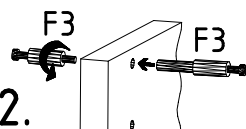
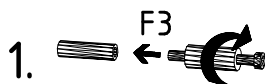

G1

T1

S0

4

SWH-SKL

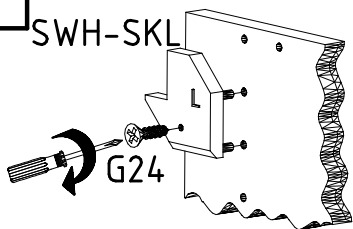

SWH-SKR

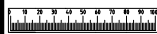
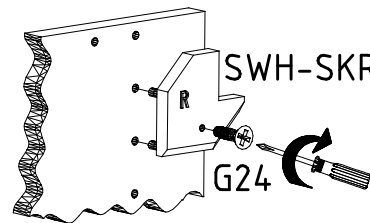

577

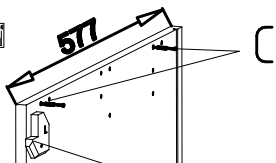

SWH-SKL + G24

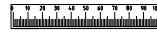
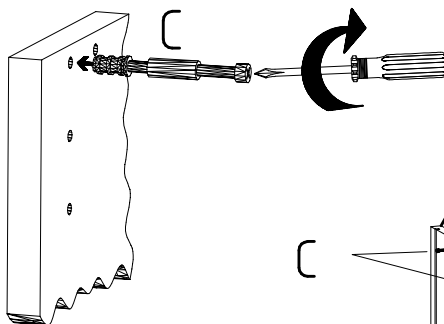

607

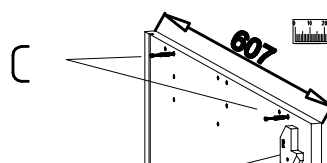

SWH-SKR + G24

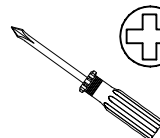

SWH-SKL

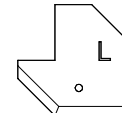

SWH-SKR

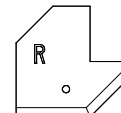

3,5 x 22 mm G24



121 004

6,3 x 10,5 mm T1

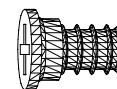

112 055

3,5 x 15 mm G1

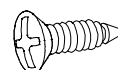

121 370

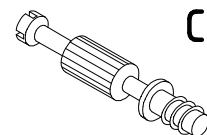

111 103

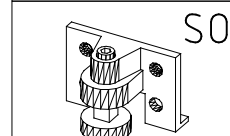

111 xxx

1

3

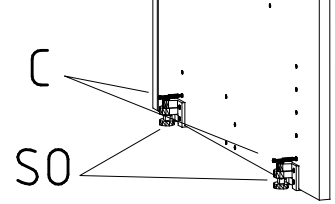
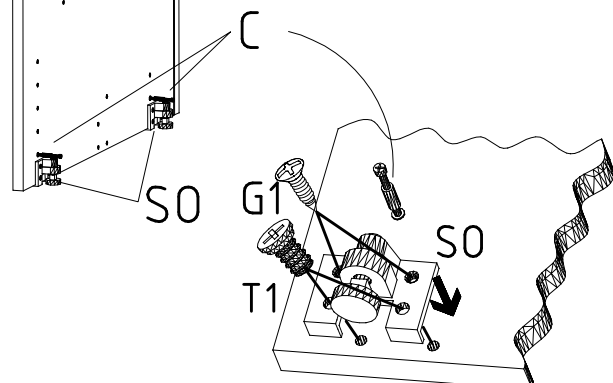

5

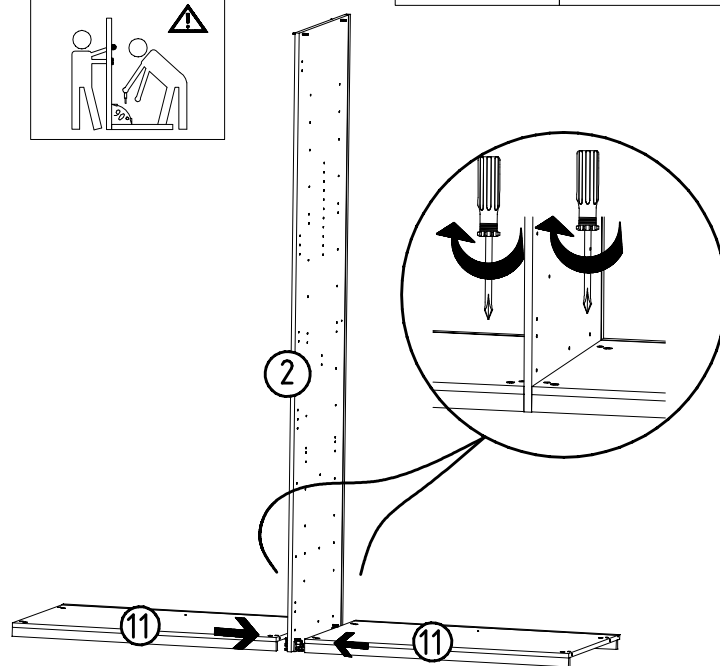
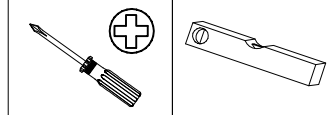

6

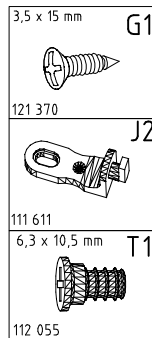
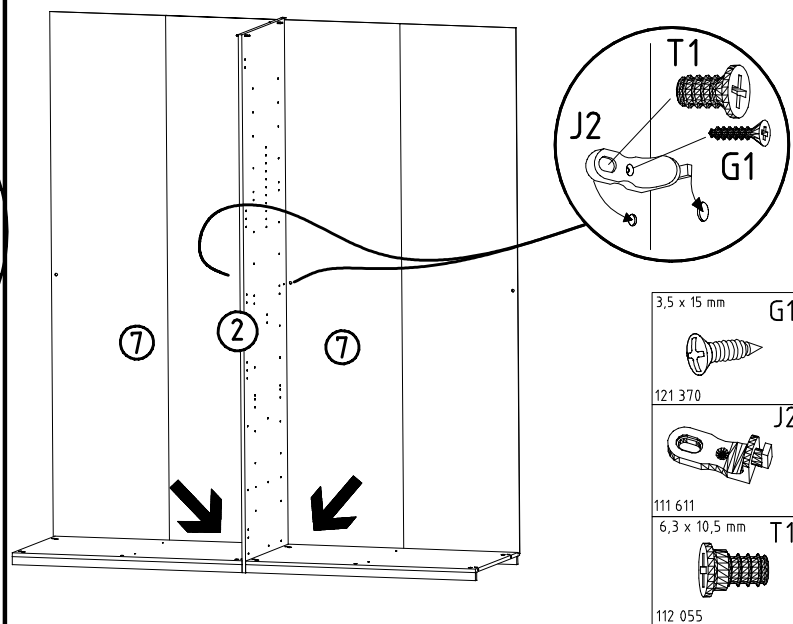
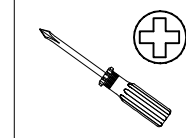

7

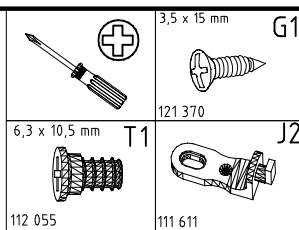

8

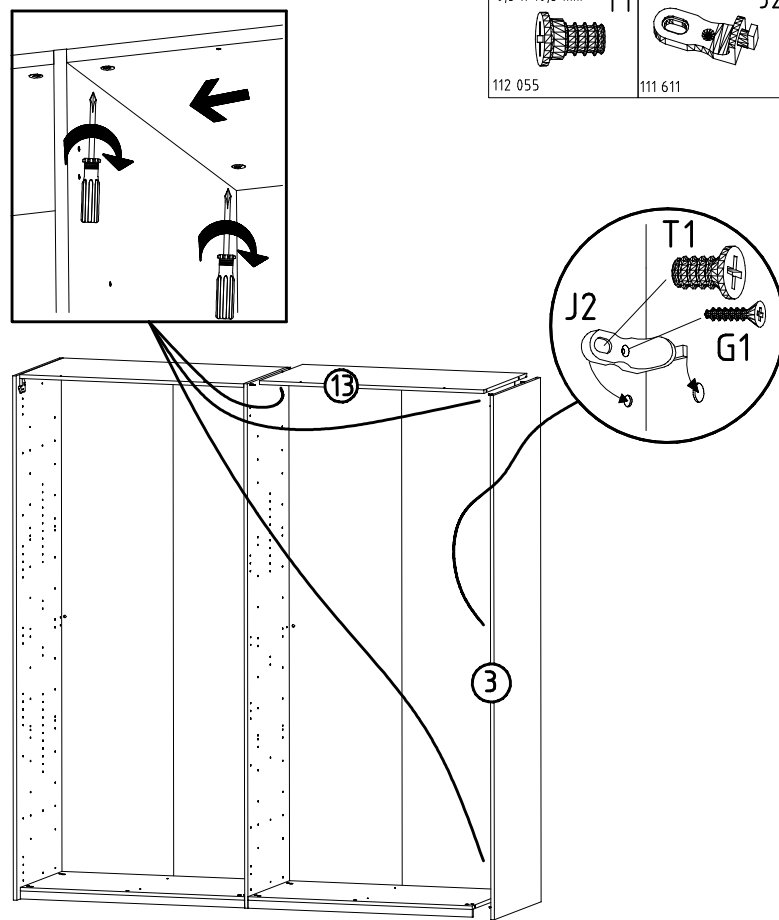
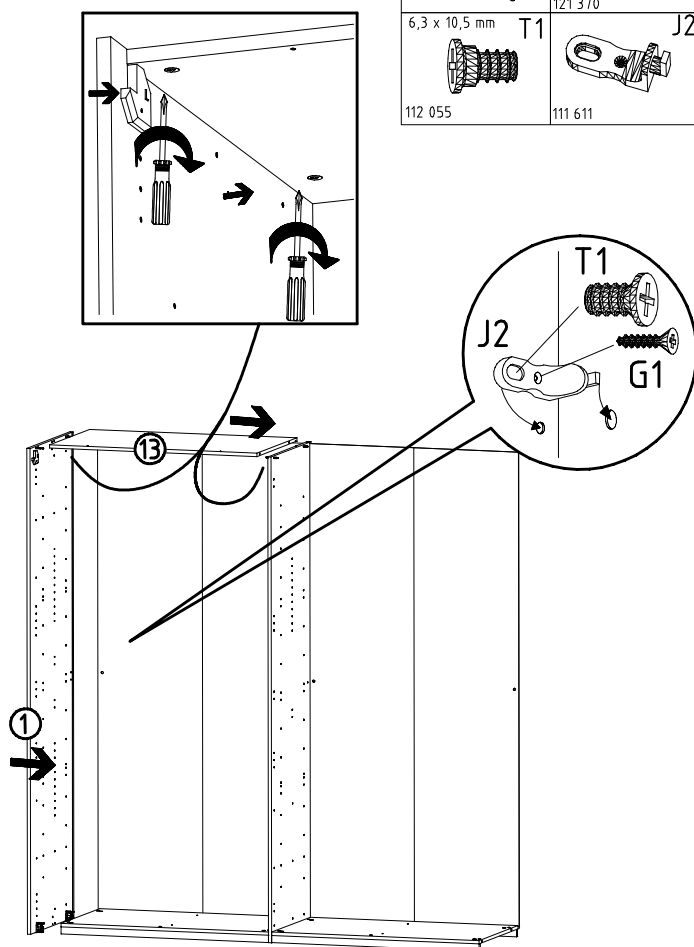
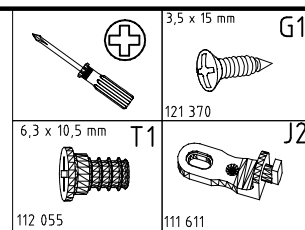

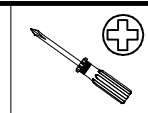

111 607

L8



K2

117 002

3,5 x 15 mm

G1

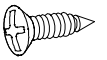

121 370

K10

100cm

112 400

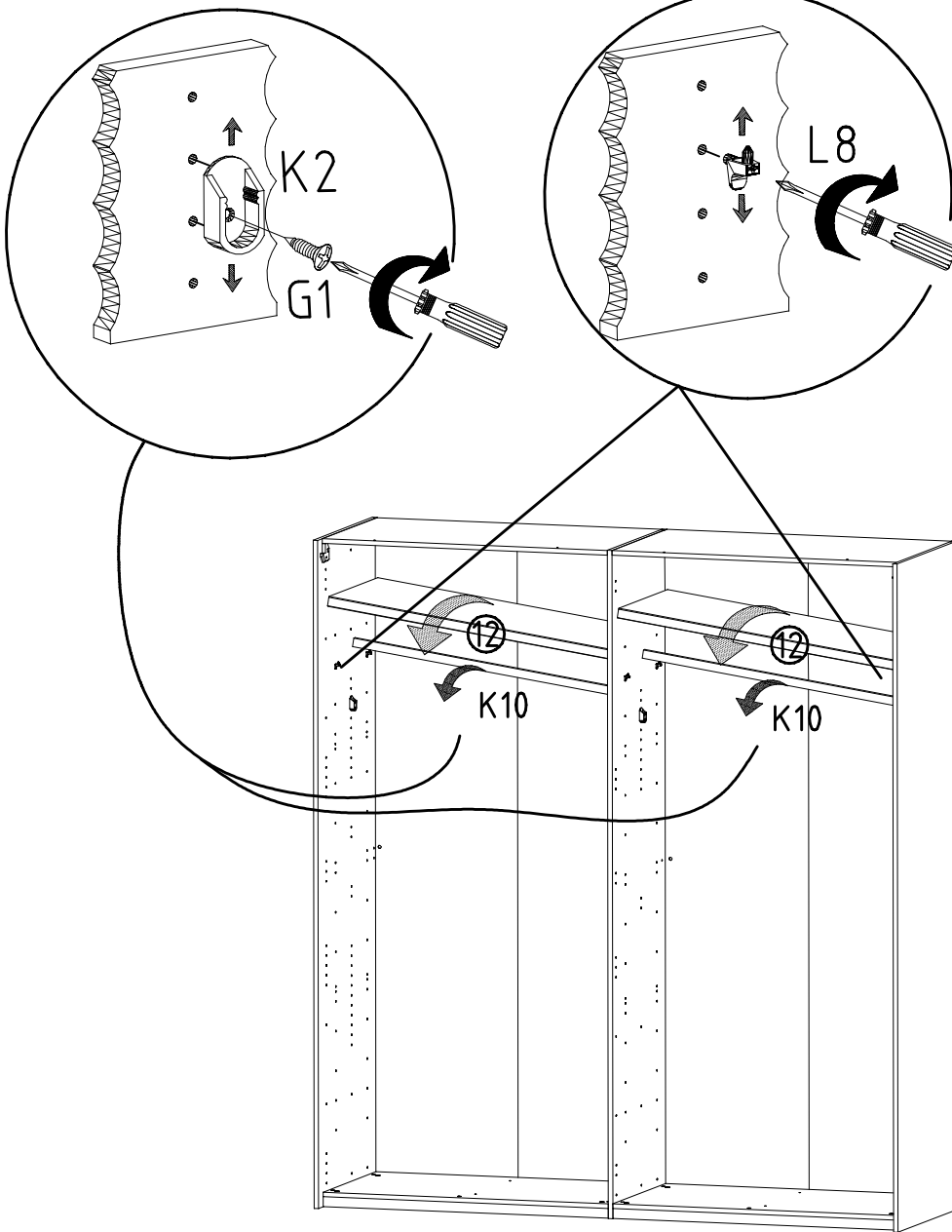

10

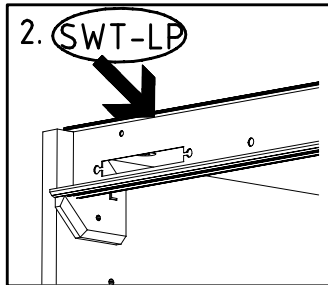
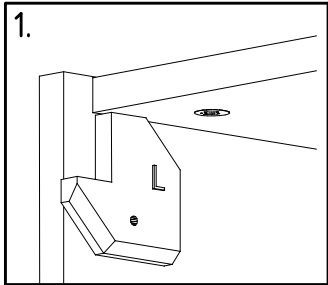

M4 x 10 mm G43 121 xxx	M4 x 13 mm GH13 121 xxx	3,5 x 35 mm G14 121 375	SWT-ST	SWT-SM5
------------------------------	-------------------------------	-------------------------------	--------	---------

SWT-LP
1453/1940/2430/2920
/3410 SY

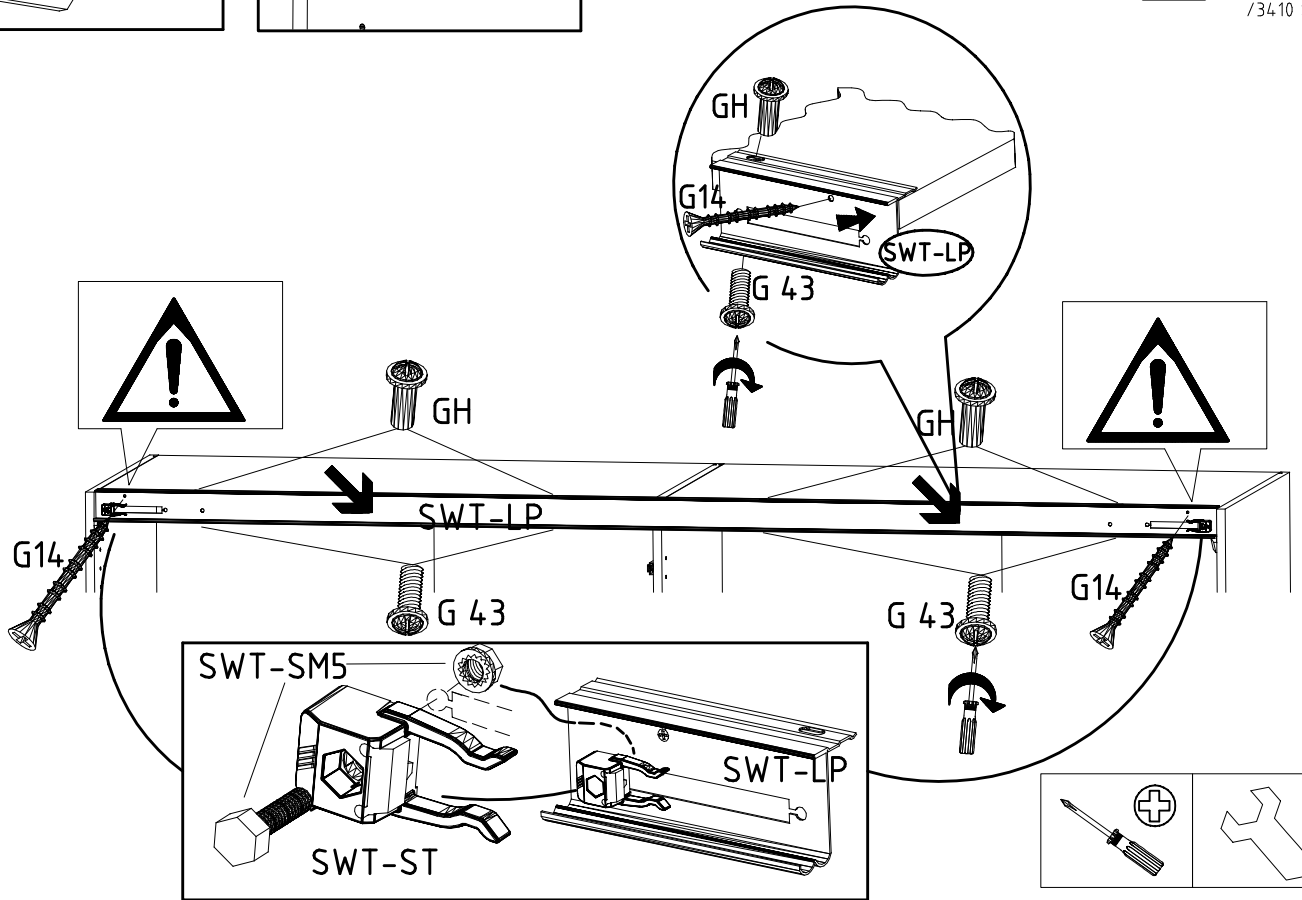

11

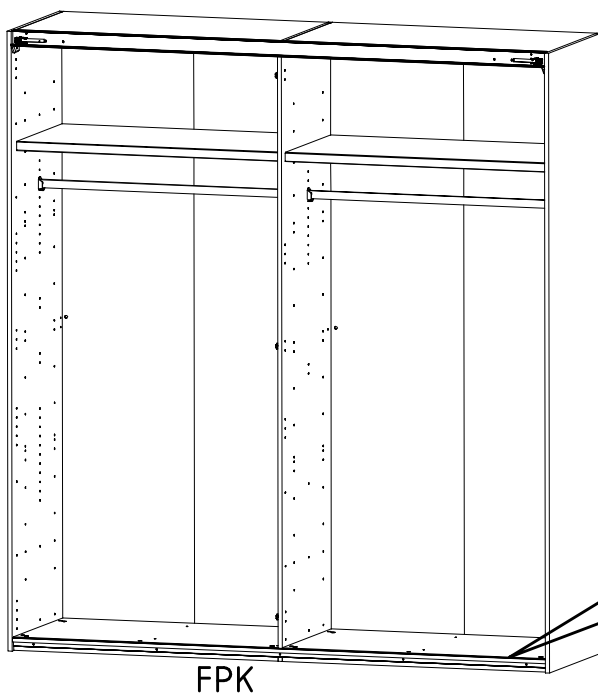

FPK 1453/1940/2430/2920/3408
3,5 x 22 mm G24 121 004

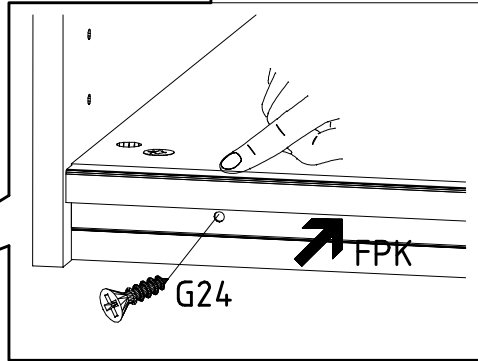

12

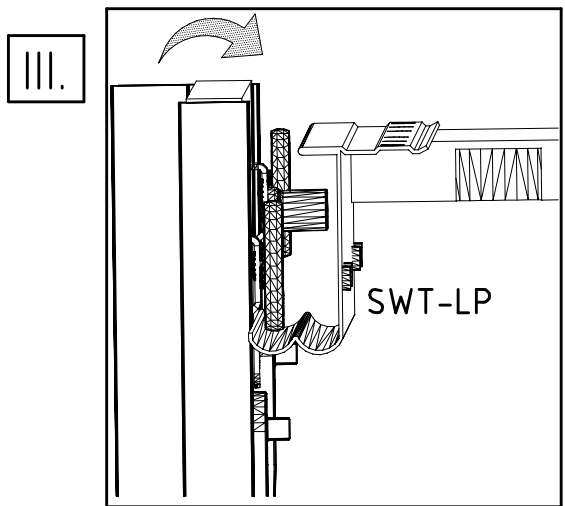
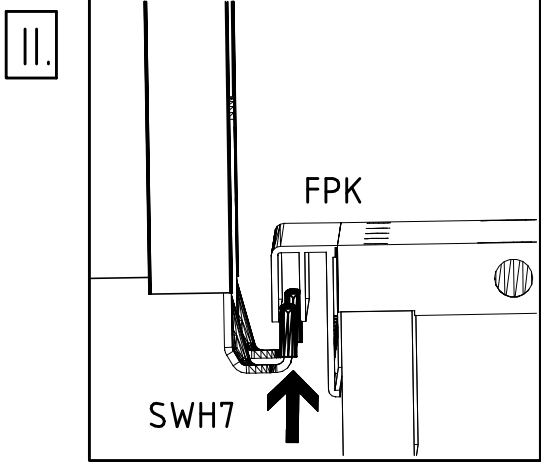
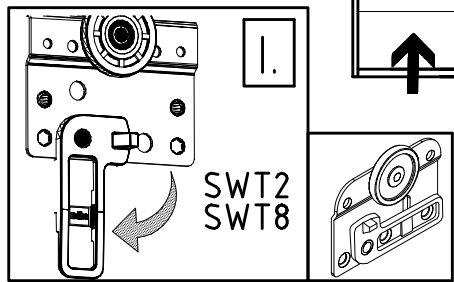

IV.

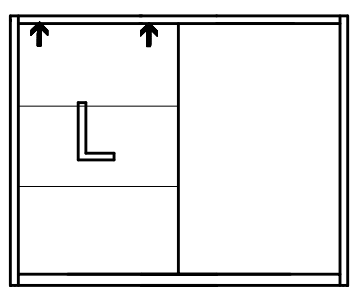
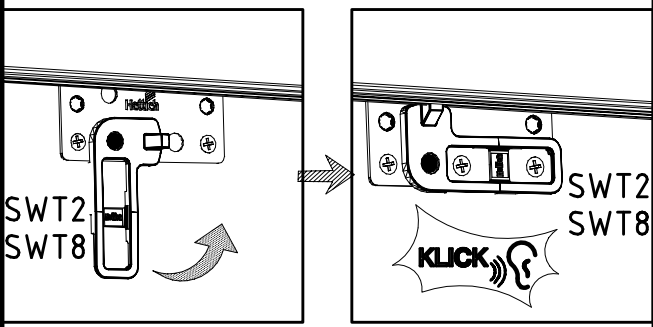

13

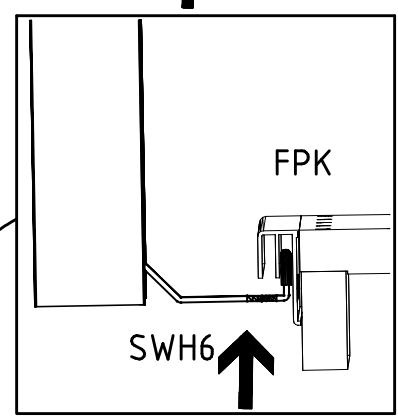
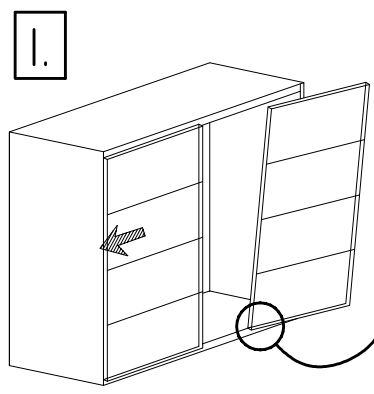
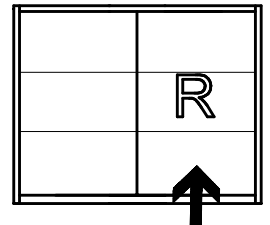
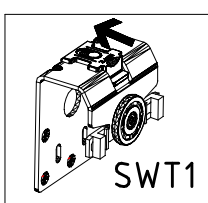

II.

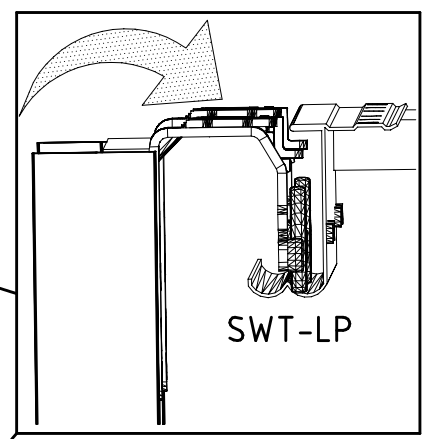
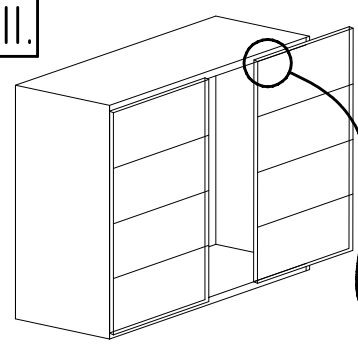

III.

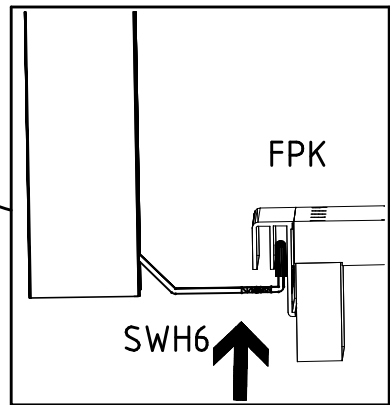
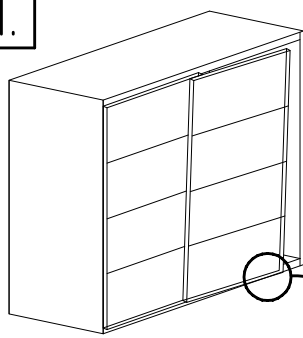

IV.

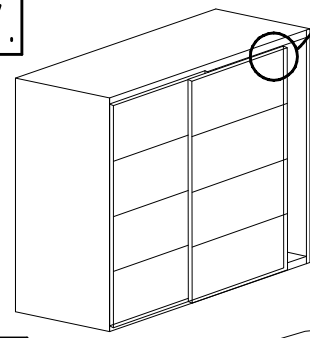

V.

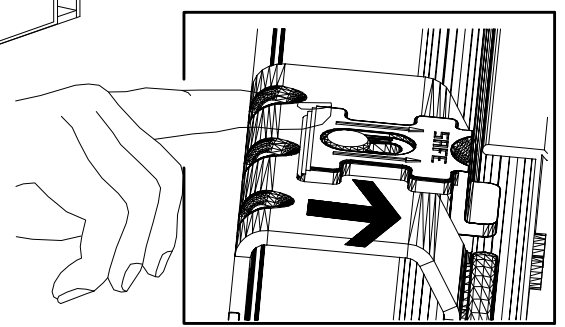
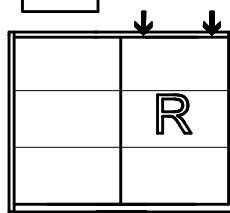

14

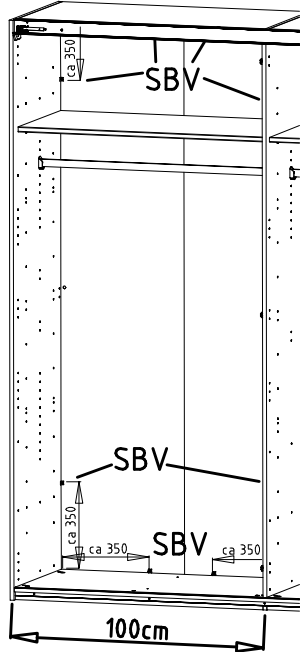
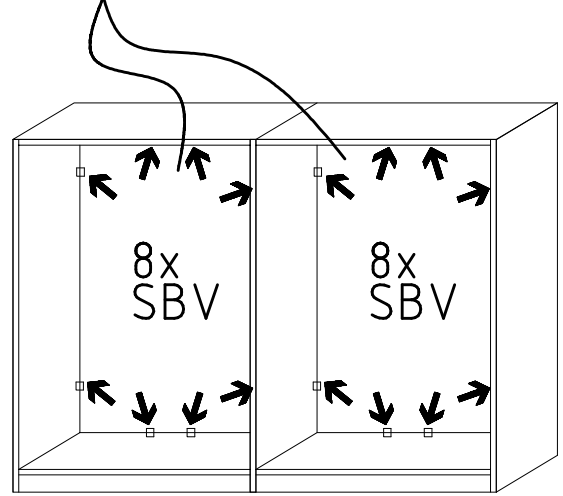
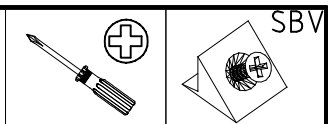
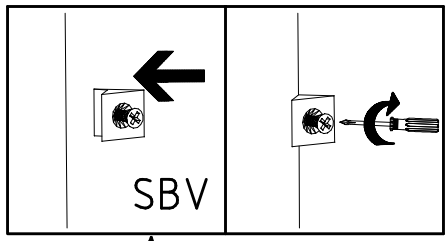

15

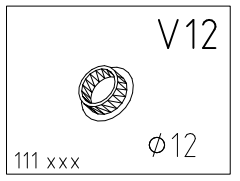
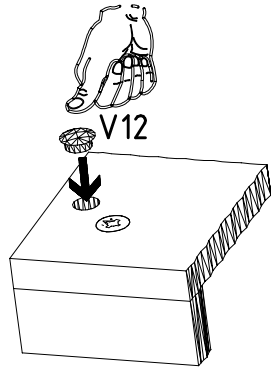
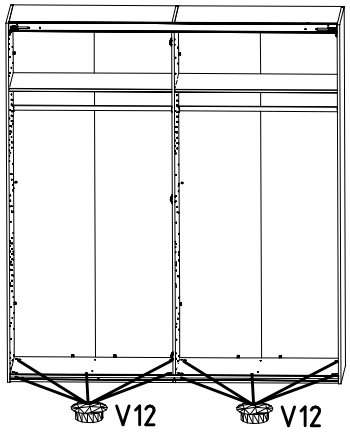

16

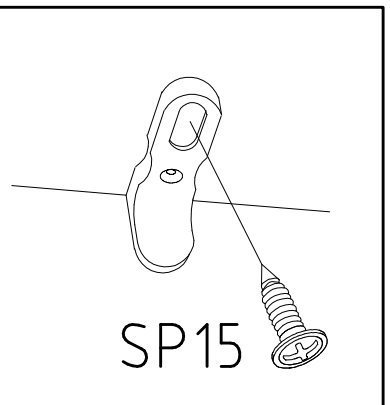
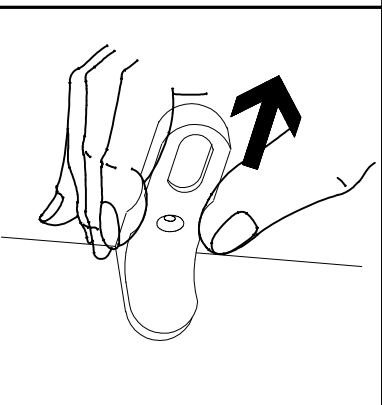
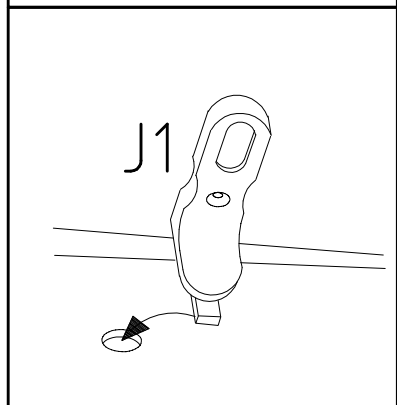
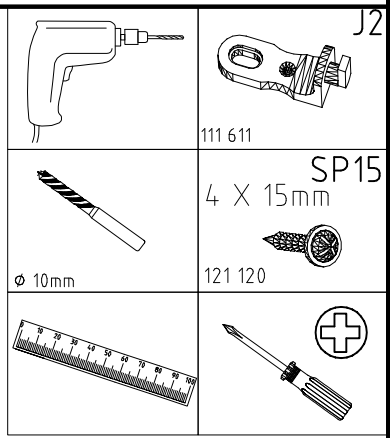
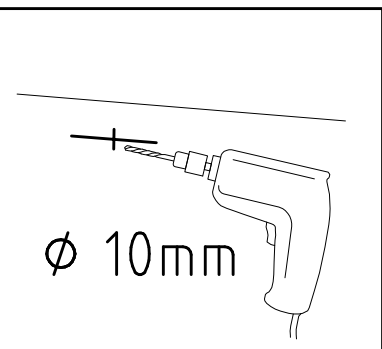
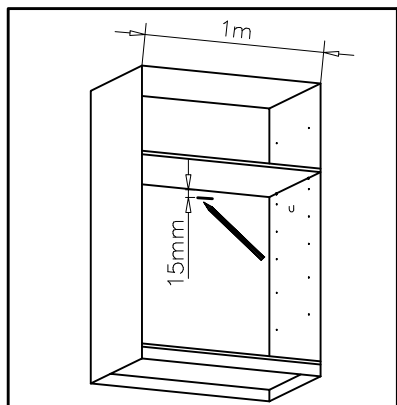

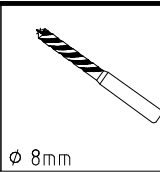
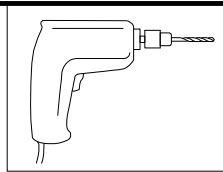

ø 8mm

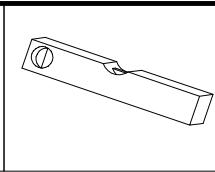
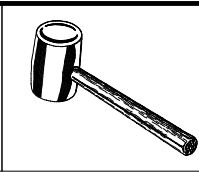

SP15
4 X 15mm
121 120

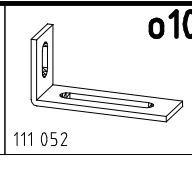

111 052

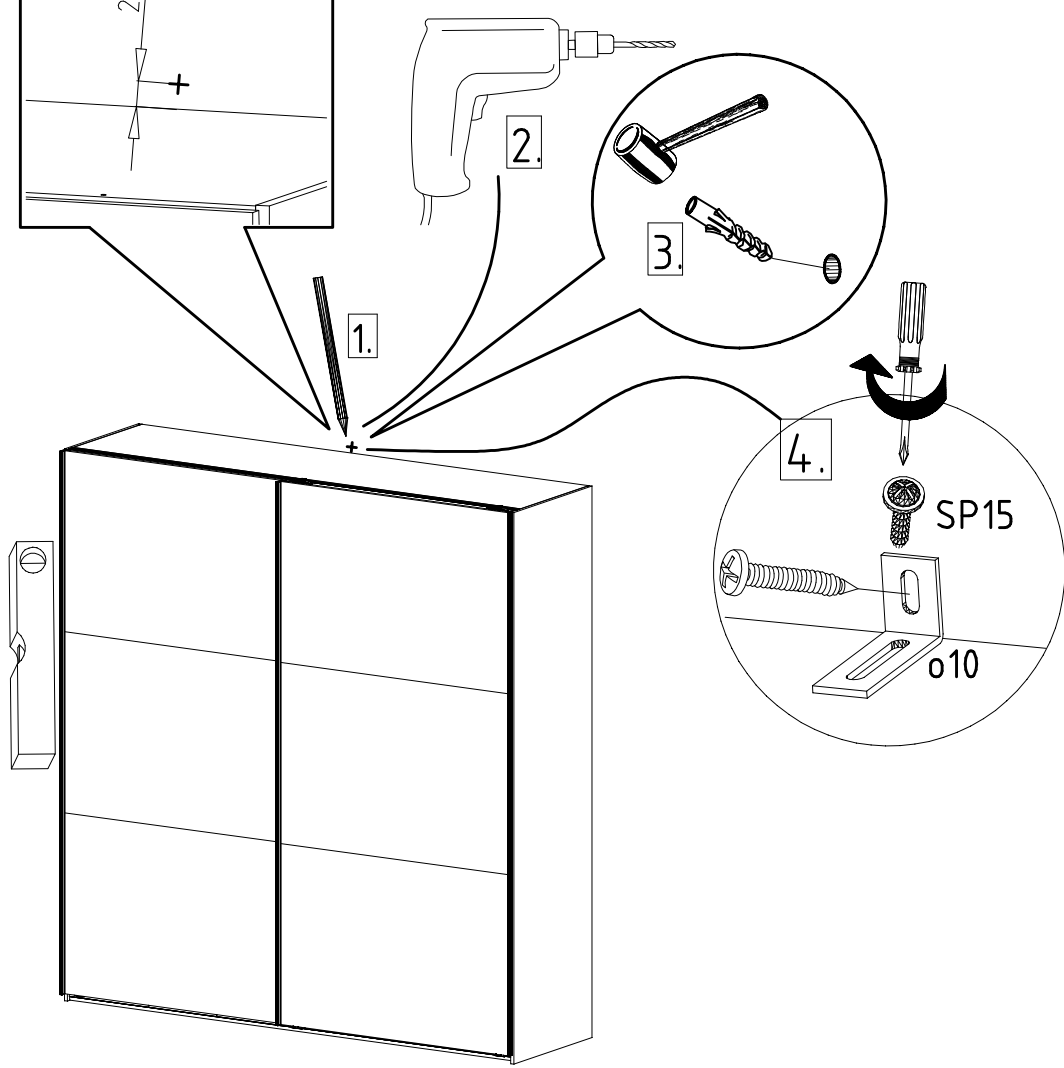
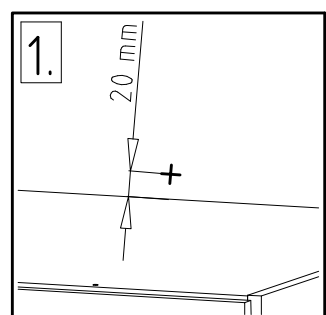
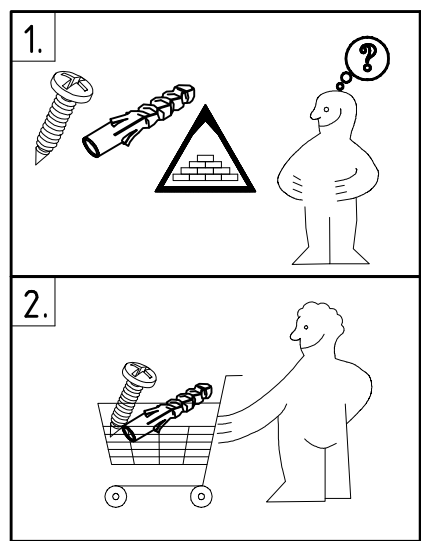

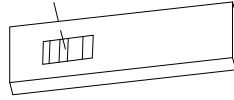
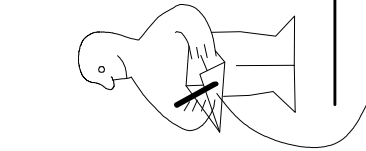
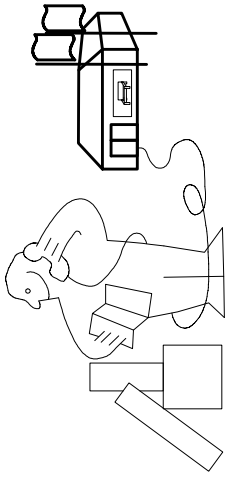
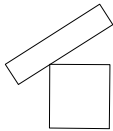
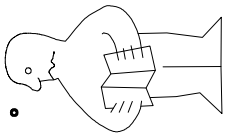

Modell/Model/Modèle



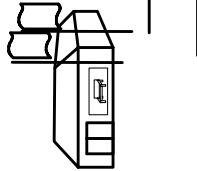

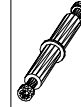
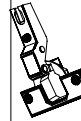
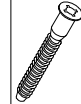

{121 370}	{ G 1 }	{4x}

Änderungen die dem technischen Fortschritt geschuldet sind, behalten wir uns vor !

Bei nicht vorschriftsmäßiger und/ oder nicht fachmännischer Montage wird bei Personen- und/ oder Sachschäden keinerlei Haftung übernommen.

WIMEX Wohnbedarf/ Import Export Handels GmbH/ Postfach 1407/ 49112 Georgsmarienhütte/ Germany
Tel.:(+49) 054-01 8598 16/17 Fax.:(+49) 054-01 8598 33 Mail: service_H@wimex-online.com

104P-NR. / 104P-NO. 150X-NR. / 150X-NO. Auftrag/Order-No. / No. de Commande

23203 **30110XY** 104

Kunde MAX MUSTERMANN
Customer
Client

Kommission / your order reference / votre reference

3377 MINDEN

Dekor / Decor Decor / Modell / Modele

F99 **SAMPLE**

F99842 SCHWEBETUERENSCHRANK 250 CM H 216CM
PLANKENEICHE NB + RAH STEEL
PLANKENEICHE NACHBILDUNG

202320301107241476000001

Paket / Package / Paquet

414760

SOCKEL

Paket 1 von 8 Colli Kommission 10

HSP-SHT BOD 50 TEXT/TEX SOCKEL 32 FRESH TV / LF 104
SO-BOD TEXT RASTEX/ ZNBOD D18MM TX KLSTA

Montage - Anleitung Laenge 520,0 OBEREN
KS-64 Breite 568,0 OBEREN

SOCKEL32 KLEB

Bei Werkstatteinrichtungen für Möbelbau beachten!
En cas d'installation réalisée retourner le bordereau d'envoi.



OBEREN 5 30/19 HAUT 23.08.19 OBEREN 1 1. JABOVE OBEREN



WIMEX Wohnbedarf
Import Export Handelsges mbH & Co. KG
Werner-von-Siemens-Str. 35
D-49124 Georgsmarienhütte - Germany

SAMPLE **23.08.19**
Modellname Produktionsdatum
Model Date of manufacture

