

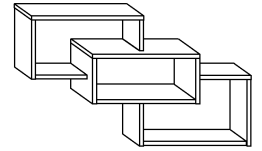

RIO-17

PÓŁKA M

→ 85 × 50 × 26



x 8

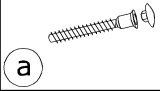

x 20

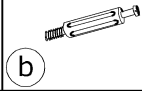

x 20

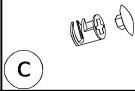

x 10

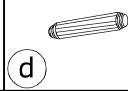

x 3 kpl.

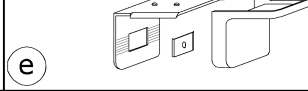

x 6

(6,2x13)



x 1

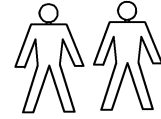
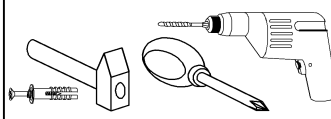
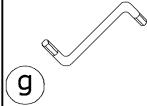

30 min

**1** - FAZY MONTAŻU**A** - OZNACZENIE ELEMENTÓW**a** - OZNACZENIE AKCESORIÓW**1**

x 20



x 10



x 3



x 6

(6,2x13)

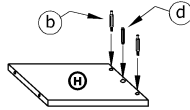
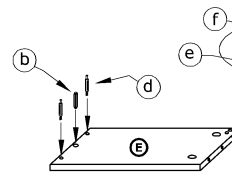
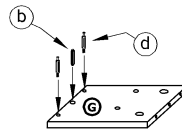
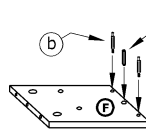
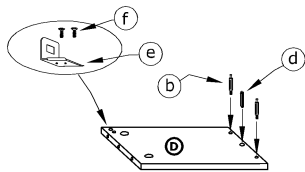
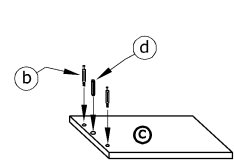
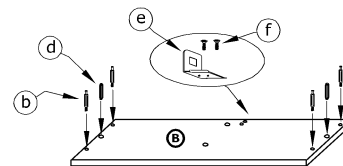
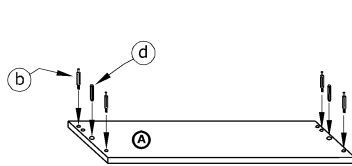
**2**

x 6

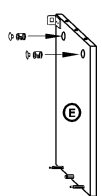
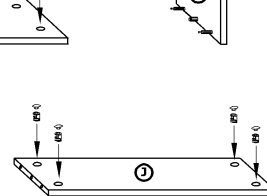
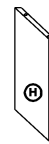
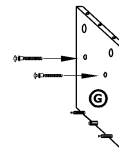
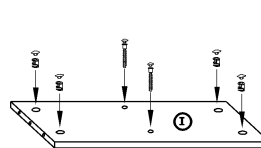
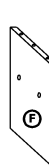
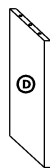

x 12

**3**

x 2

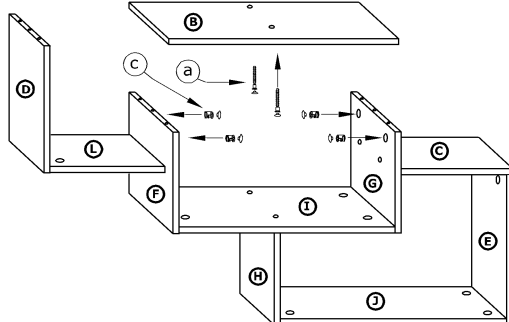

x 4

**4**

x 4

