

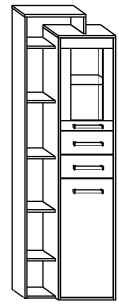

RIO-27

WITRYNA L1D2S

→ 64 + 203 \ 41



x 14 a	x 28 b	x 28 c	x 22 d	x 4 e	x 4 f	
x 14 g	x 6 h	x 4 i	x 32 (3,5x16) j	x 8 (3,5x30) k	x 70 m	x 1 n
x 4 l	x 2 kpl. (350 mm) o				 60 min 	



1 - FAZY MONTAŻU

A - OZNACZENIE ELEMENTÓW

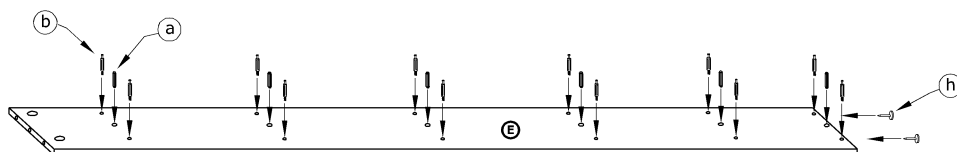
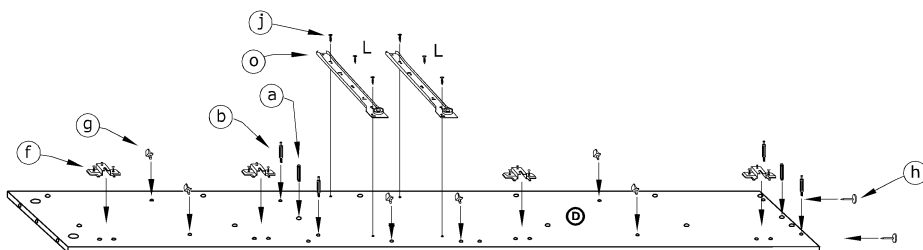
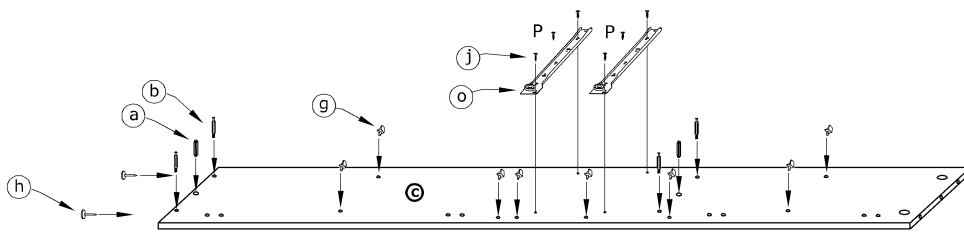
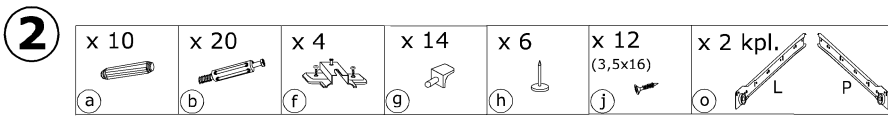
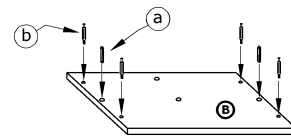
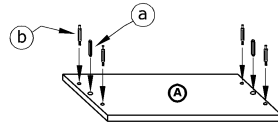
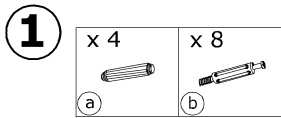
a - OZNACZENIE AKCESORIÓW



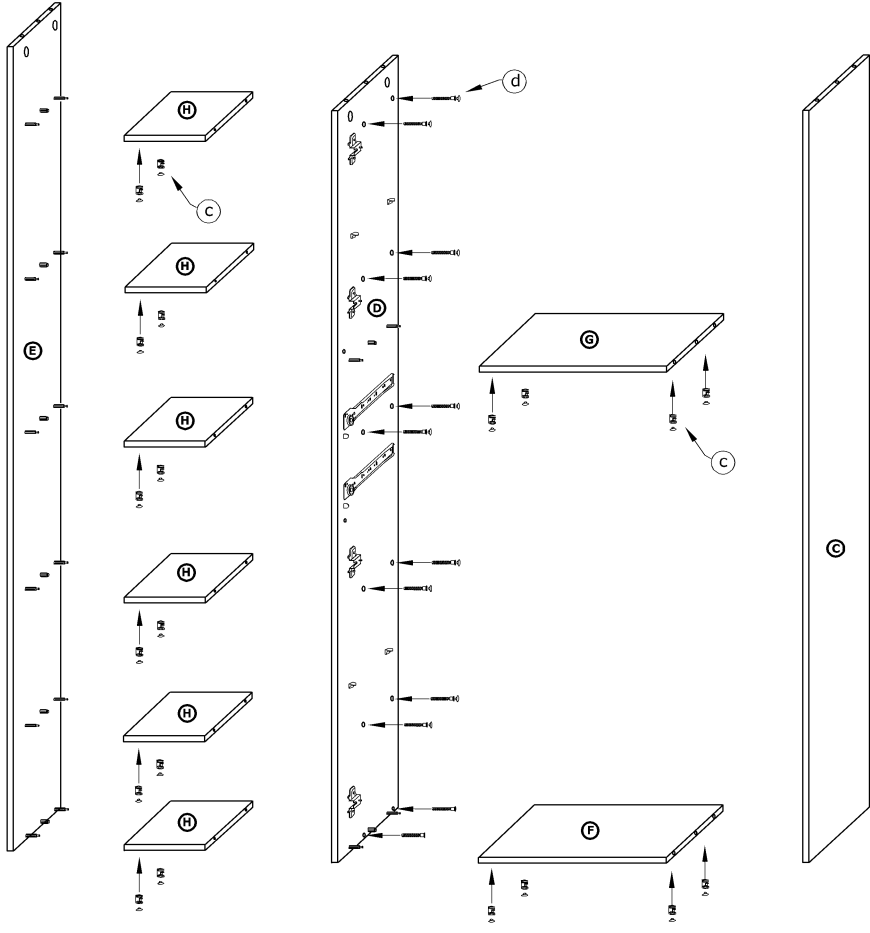

3

- x 20
- (c) 
- x 12
- (d) 



4

- x 8
- (c) 
- x 2
- (d) 

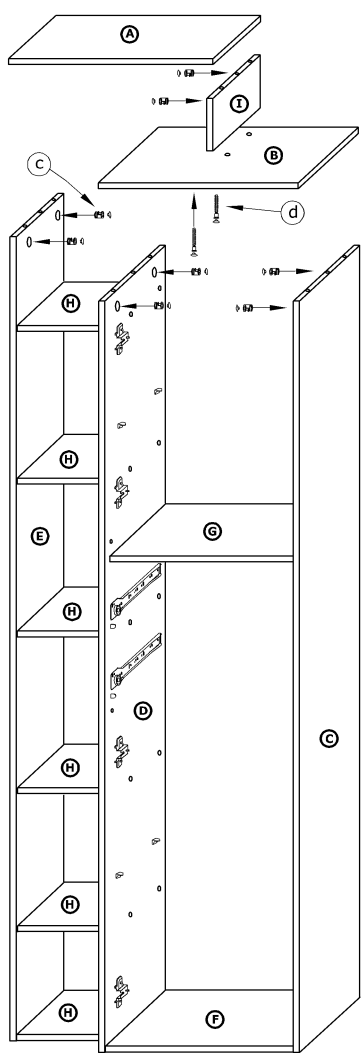

5

x 40

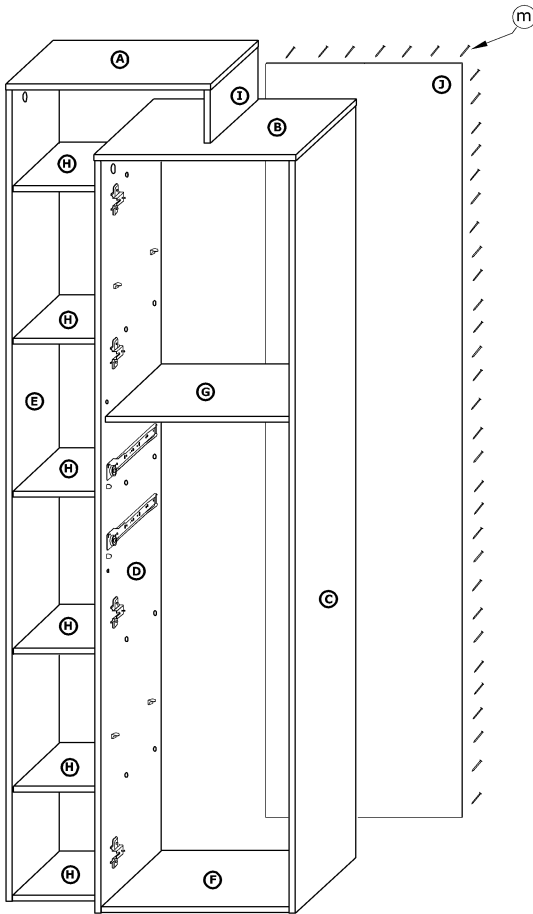
**6**

x 8



x 4



x 12

(3,5x16)



x 4

(3,5x30)



x 2



x 30



x 2 kpl.

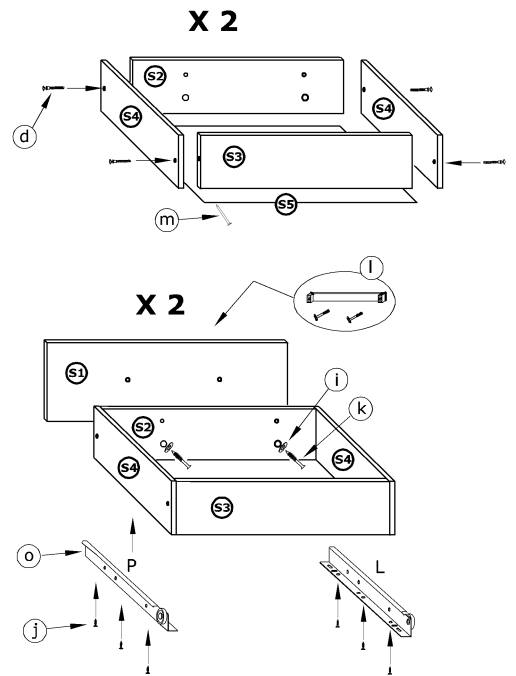

x 2 kpl.

**7**

x 4



x 8

(3,5x16)



x 4

(3,5x30)



x 2

