

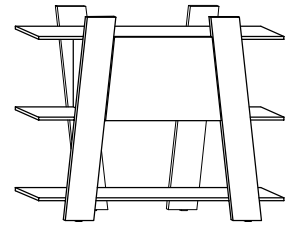

VIA-04 REGAŁ 130-2D

→ 130 ↑ 108 ↘ 29



x 32



(a)

x 32



(b)

x 4

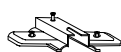

(c)

x 4



(d)

x 5



(e)

x 4



(f)

x 13

(3,5x16)



(g)

x 1

(120 mm)



(h)

x 2

(390 mm)

(i)

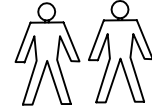

40 min



① - FAZY MONTAŻU

Ⓐ - OZNACZENIE ELEMENTÓW

Ⓐ - OZNACZENIE AKCESORIÓW

①

x 24



(a)

x 2

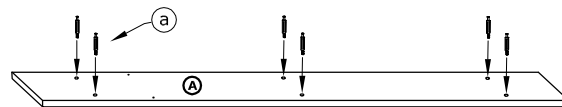

x 2

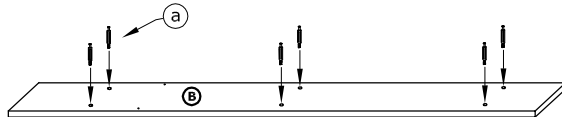

②

x 8



(a)

x 4



(c)

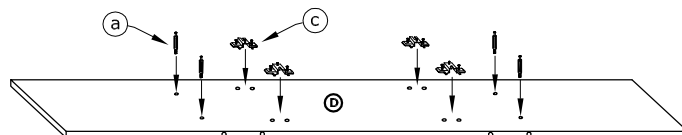
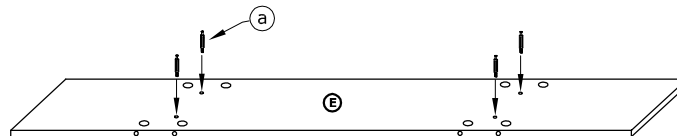

③



x 8

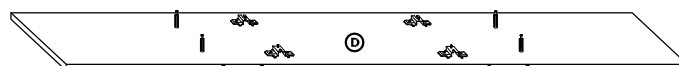
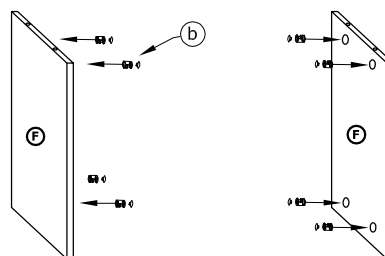
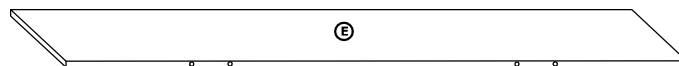

(b)



4

x 8	x 2
	
(b)	(f)

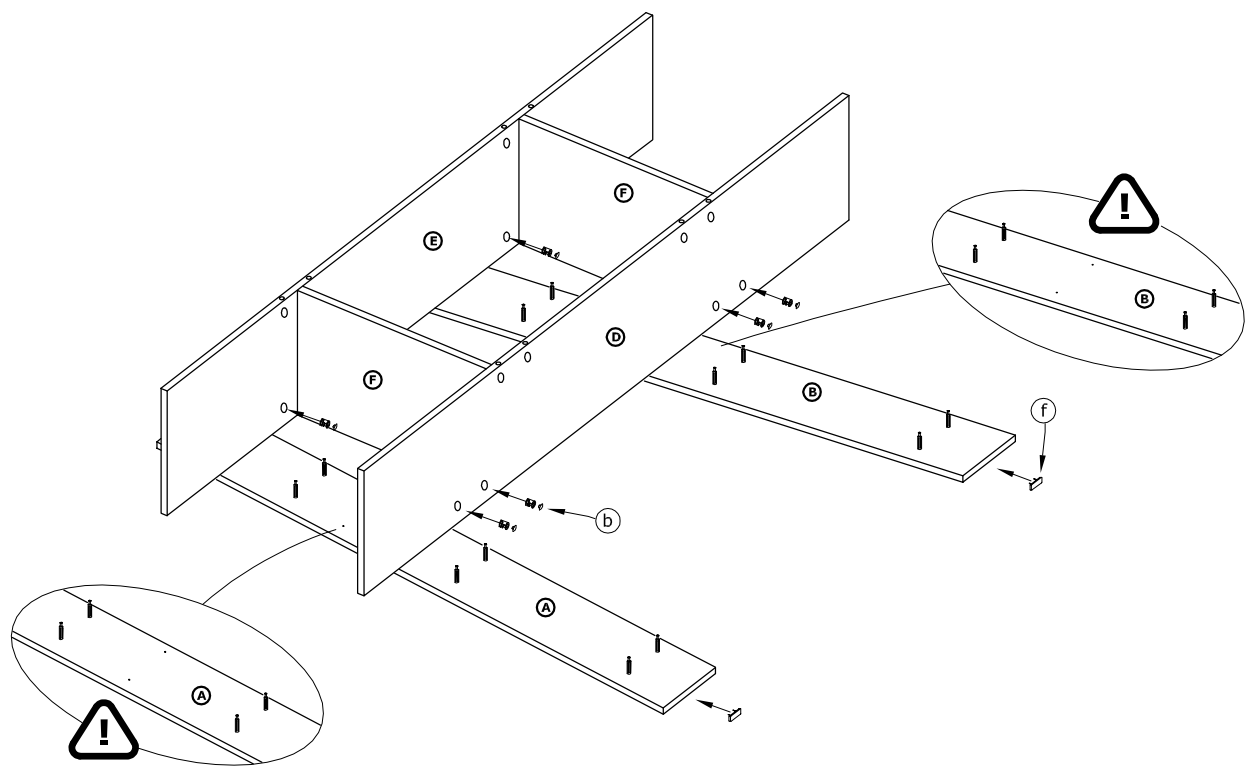

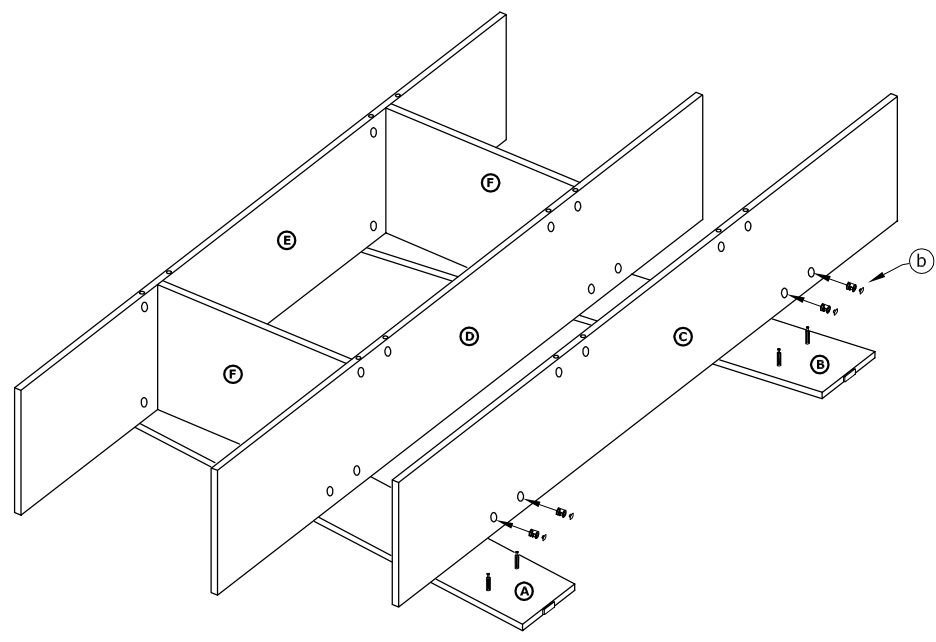

5

x 4

(b)





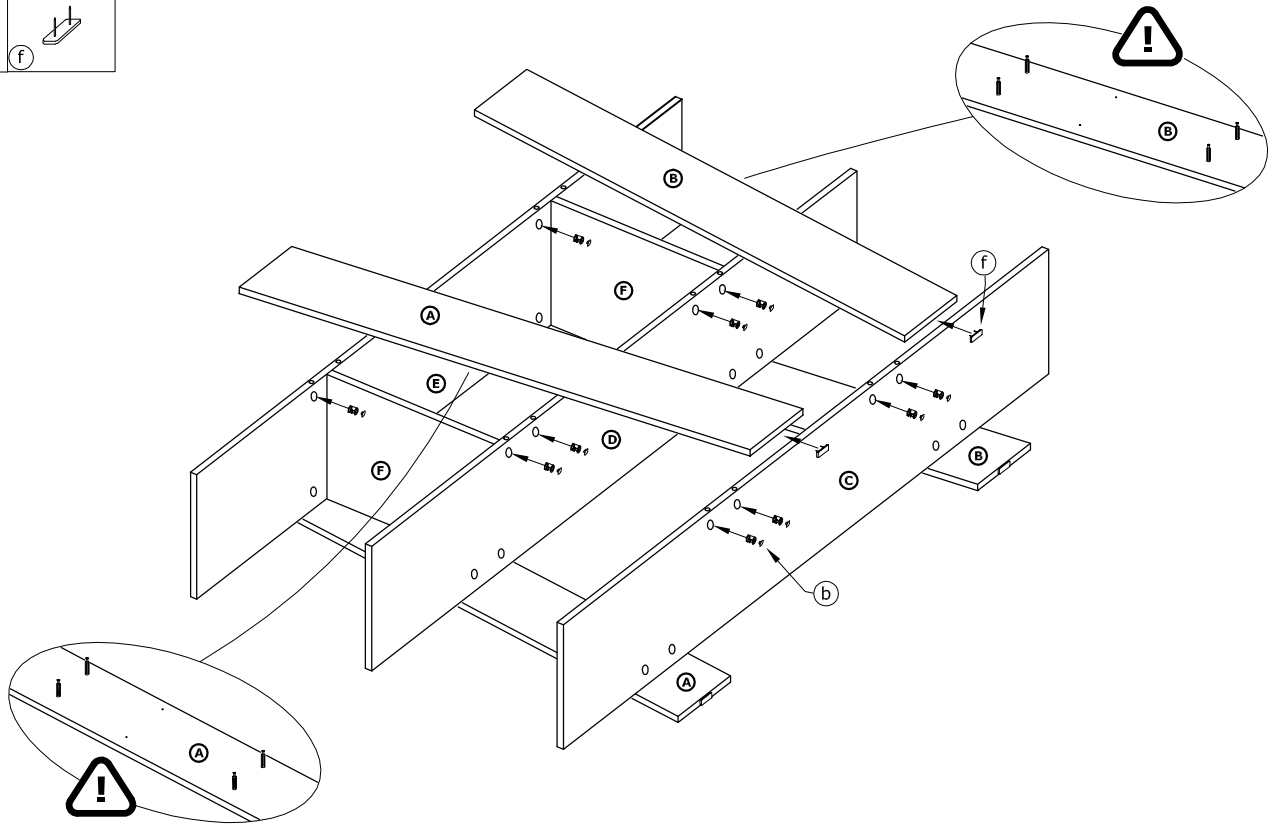

6

x 12	x 2
	
(b)	(f)



7

x 4	x 5
	
(d)	(e)
x 13	x 1
	
(g)	(h)
x 2	
	
(i)	

