

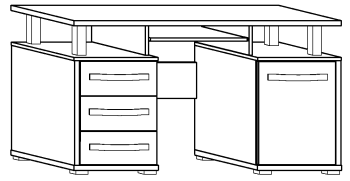

# ANG-03

## ANGEL- BIURKO 1D3S

-135 +77 \58



x 12 	x 8 	x 20 	x 16 	x 4 	x 2 
x 2 	x 6 	x 4 kpl. (400 mm) 	x 8 	x 4 	 60 min
x 4 160 mm 	x 4 	x 4 	x 50 (3,5x16) 		
x 16 (4x20) 	x 8 (4x25) 	x 12 (3,5x30) 	x 4 	x 80 	

① - FAZY MONTAŻU

Ⓐ - OZNACZENIE ELEMENTÓW

Ⓐ - OZNACZENIE AKCESORIÓW

**1**

x 4

x 4 186 mm

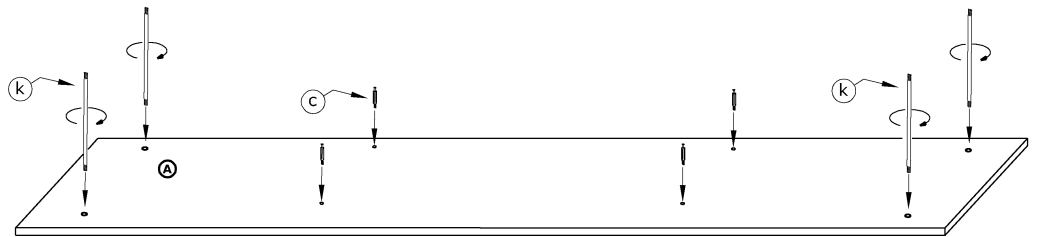

**2**

x 1 kpl.

x 6 (3,5x16)

x 2

x 2

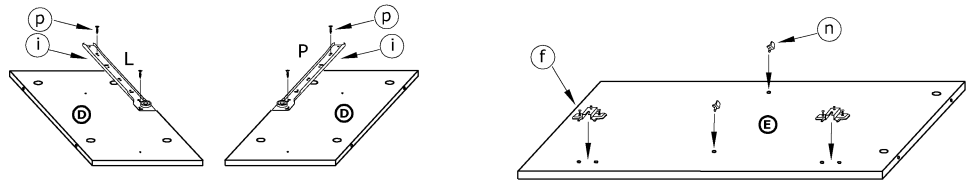

**3**

x 3 kpl.

x 18 (3,5x16)

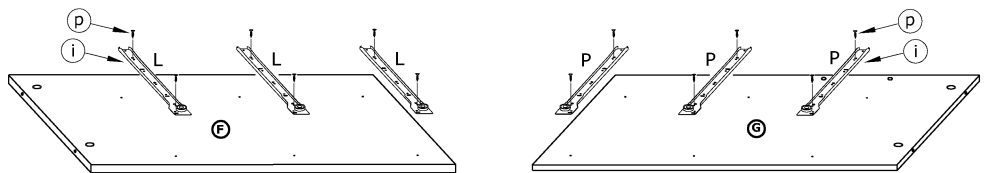



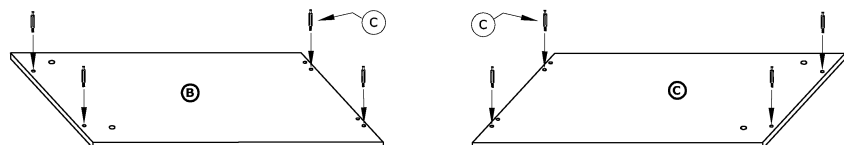

**4**

x 8





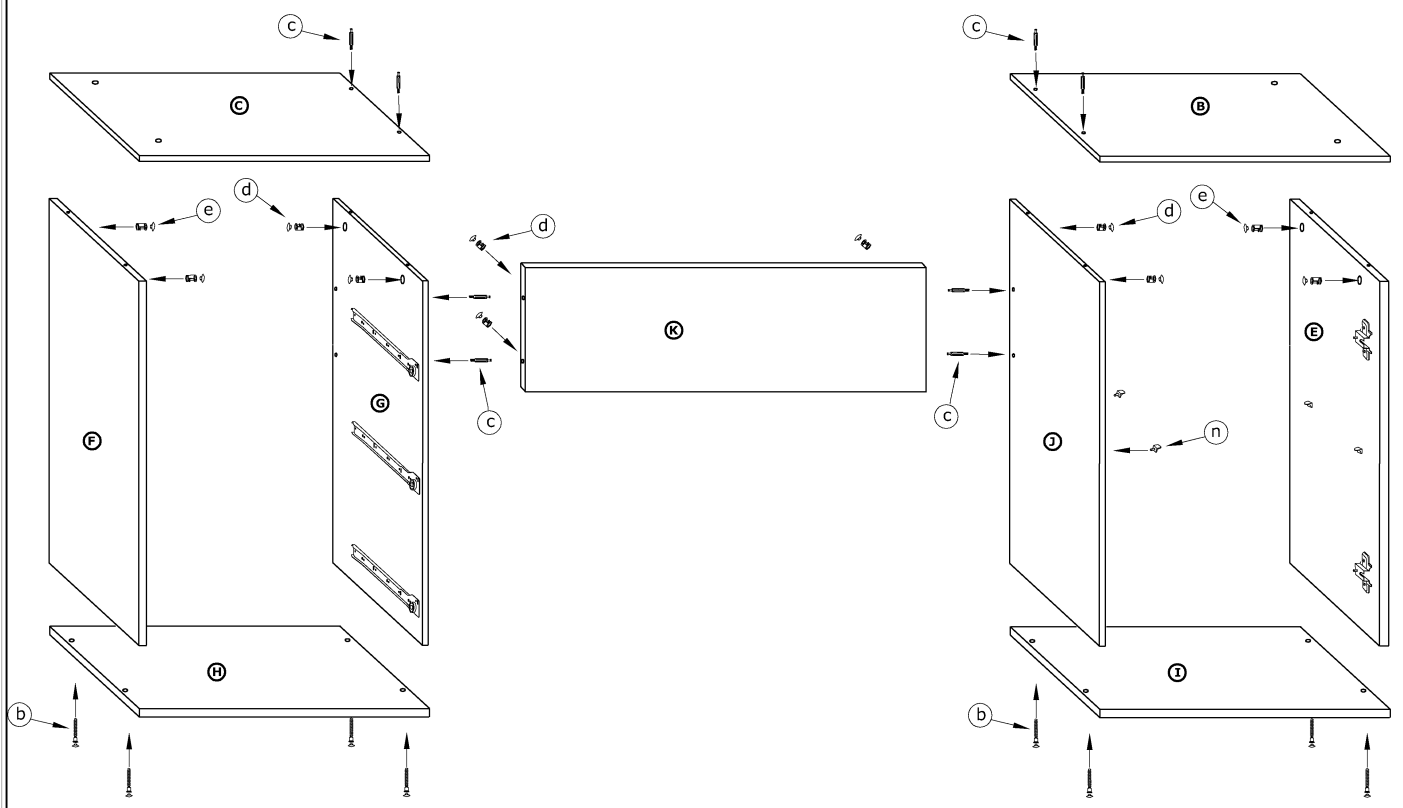

5

- x 8  (b)
- x 8  (c)
- x 8  (d)
- x 4  (e)
- x 2  (n)



6

- x 8  (d)
- x 4 160 mm  (l)
- x 8  (j)
- x 16 (4x20)  (r)
- x 4  (u)

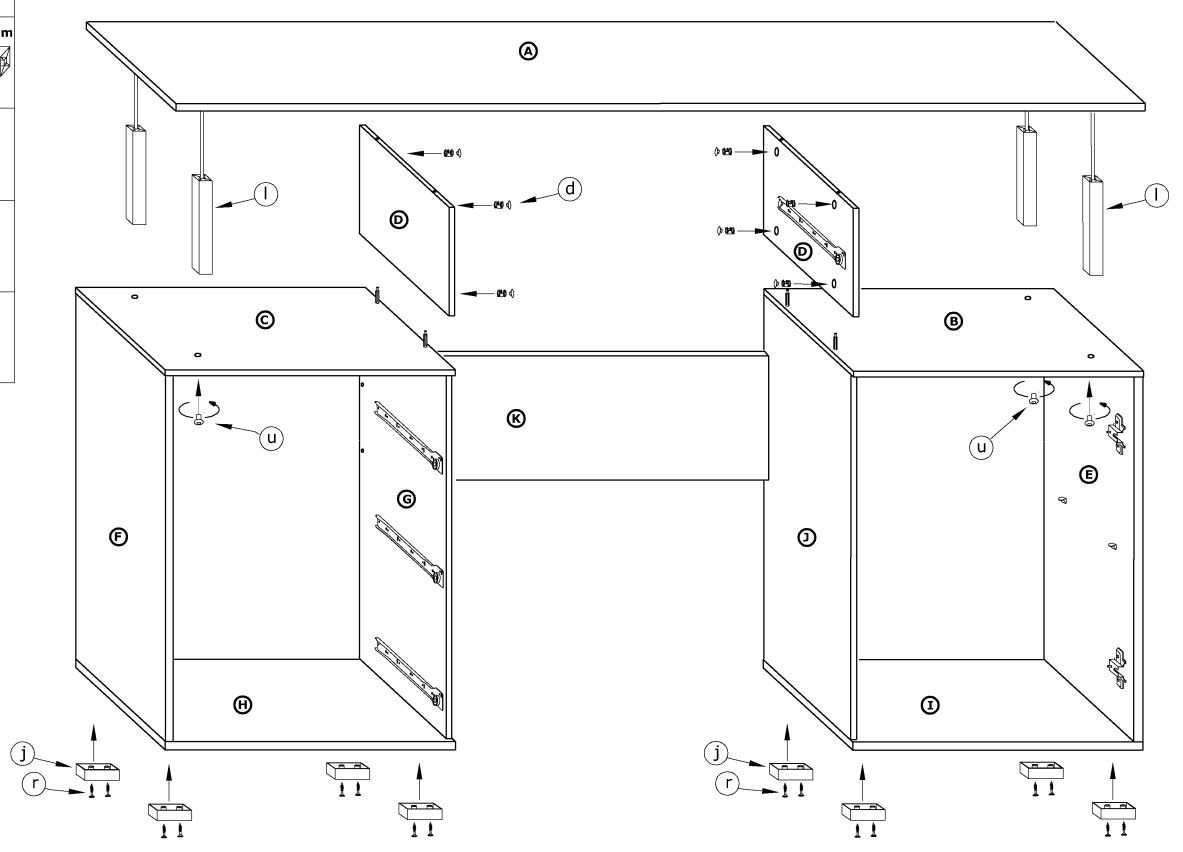

7

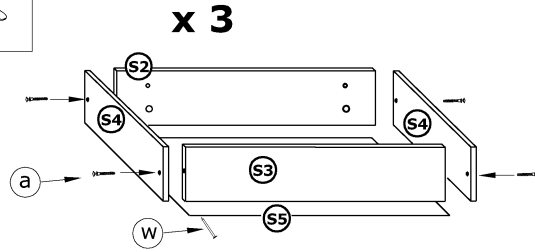
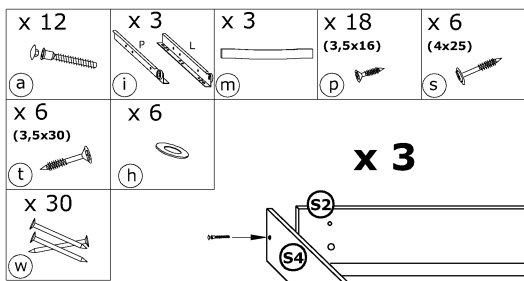

x 3

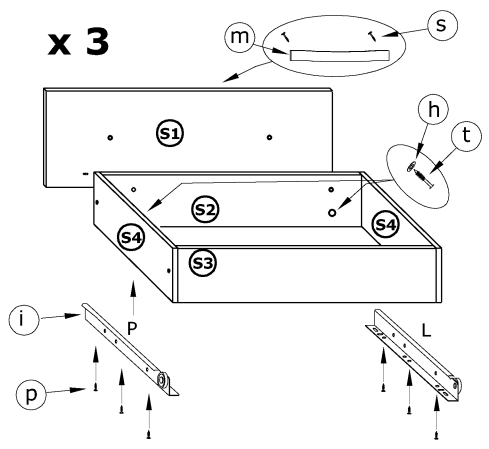

8

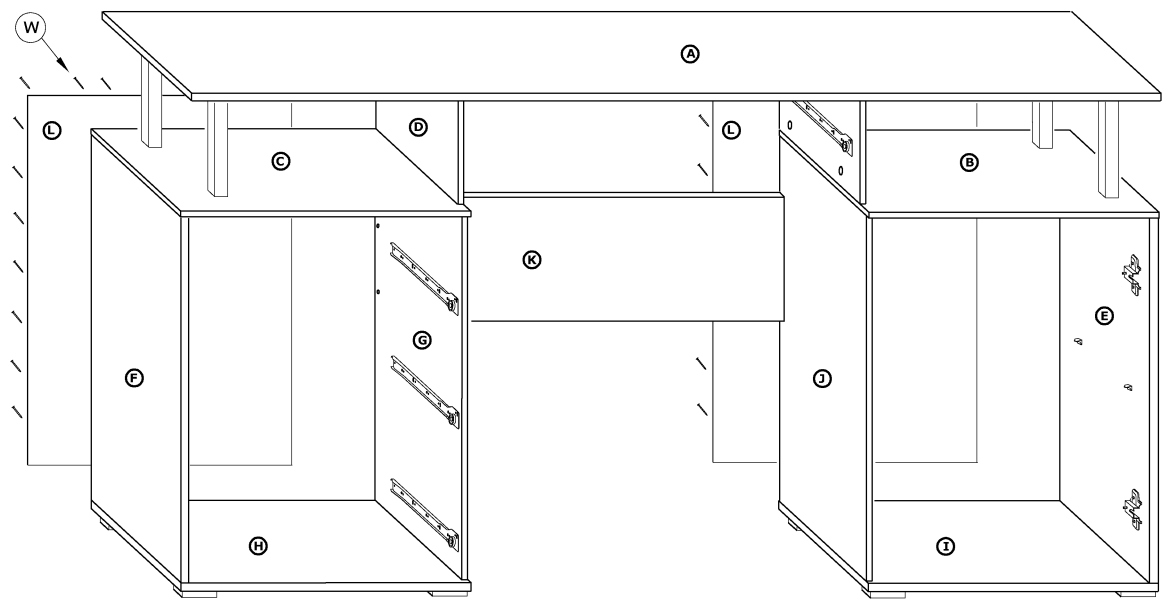
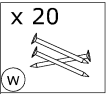

9

