

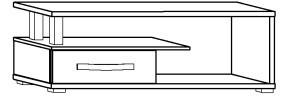

ANG-12 ANGEL- STOLIK RTV 1D

→ 118 43 \ 43



x 6



(a)

x 6

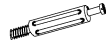

(b)

x 4



(c)

x 2



(d)

x 2

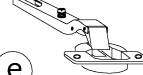

(e)

x 2

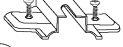

(f)

x 4



(g)

x 2
186 mm

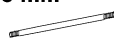

(h)

x 2
160 mm

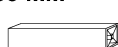

(i)

x 1

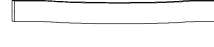

(j)

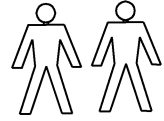

25 min



x 4
(3,5x16)



(k)

x 8
(4x20)



(l)

x 2
(4x25)



(m)

x 2



(n)

x 20



(o)

x 1



(p)

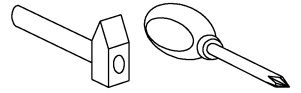

1 - FAZY MONTAŻU

A - OZNACZENIE ELEMENTÓW

a - OZNACZENIE AKCESORIÓW

1



x 2



x 2
186 mm

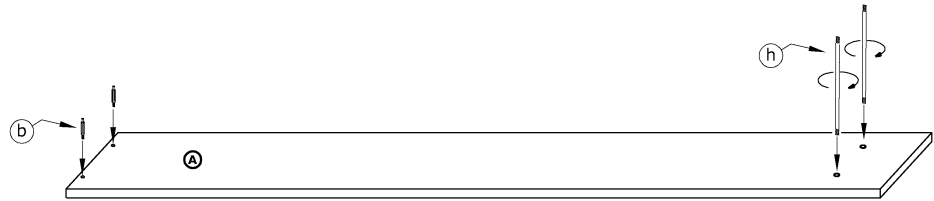

2



x 4

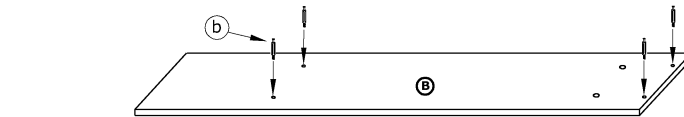

3



x 6



x 4



x 2

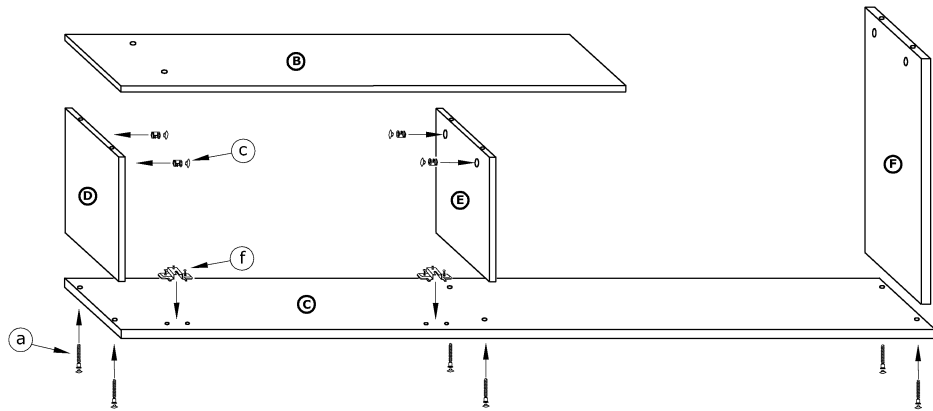

4



x 2



x 2



x 4



x 2
160 mm



x 1



x 4
(3,5x16)



x 8
(4x20)



x 2
(4x25)



x 2



x 20

