

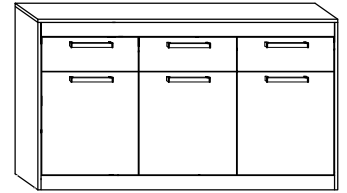

MXS-10 KOMODA 3D3S

→ 148 × 85 × 44



x 8 	x 18 	x 4 	x 22 	x 18 	x 6 	
(a)	(b)	(c)	(d)	(e)	(f)	
x 7 	x 1 	x 54 (3,5x16) 	x 12 (3,5x30) 	x 6 	x 95 	
(g)	(h)	(i)	(j)	(k)	(l)	(m)
x 6 	x 2 	x 4 	x 12 	x 2 	x 3 kpl. (350 mm) 	
(n)	(o)	(p)	(s)	(t)	(r)	90 min



1 - FAZY MONTAŻU

A - OZNACZENIE ELEMENTÓW

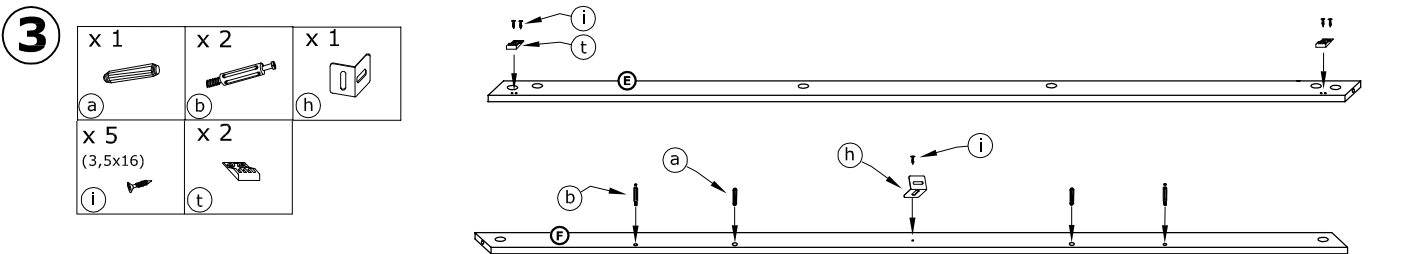
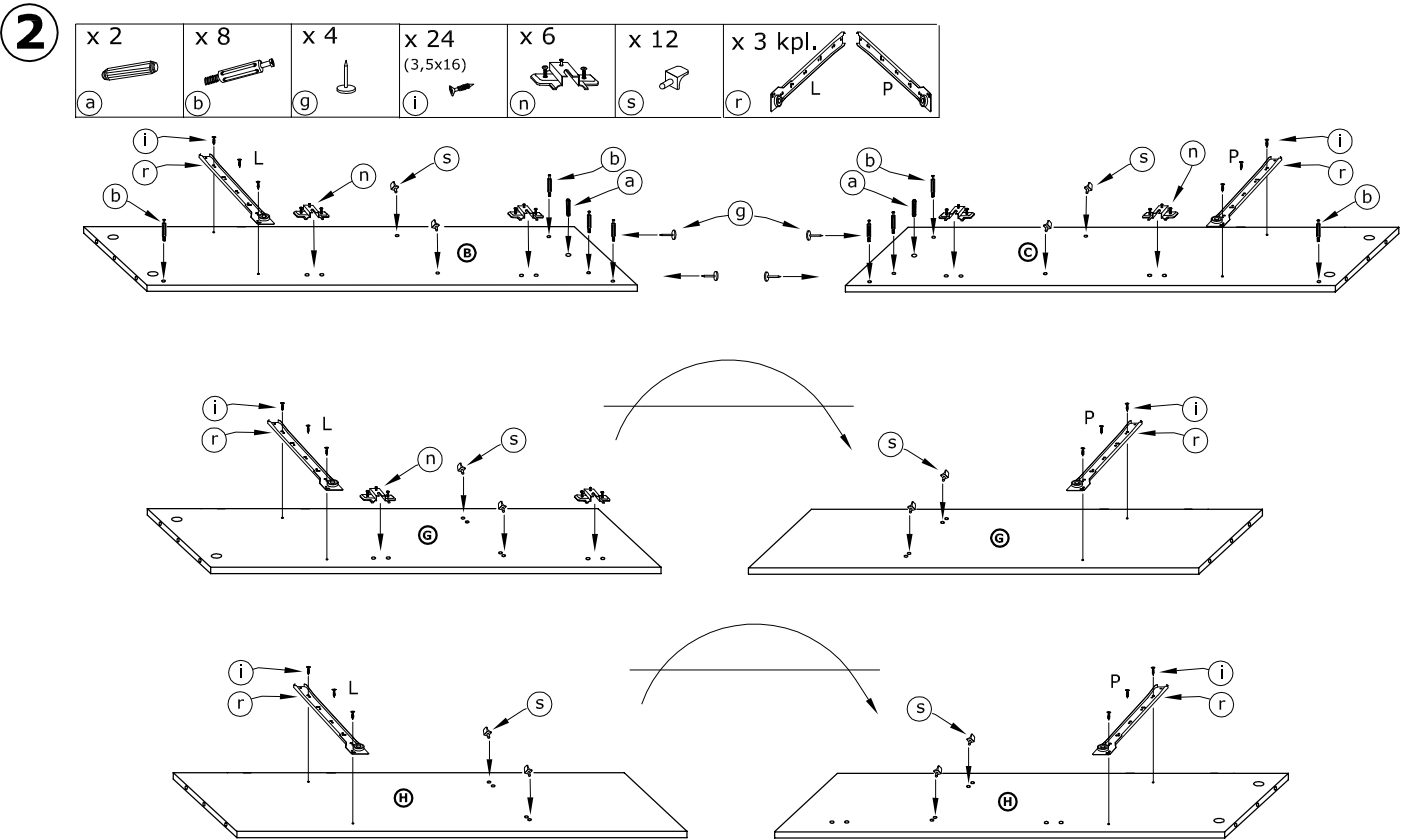
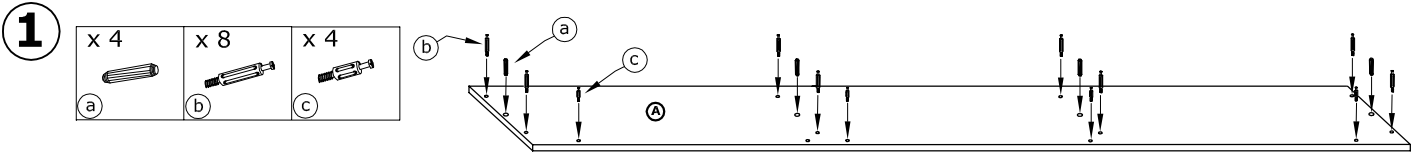
a - OZNACZENIE AKCESORIÓW



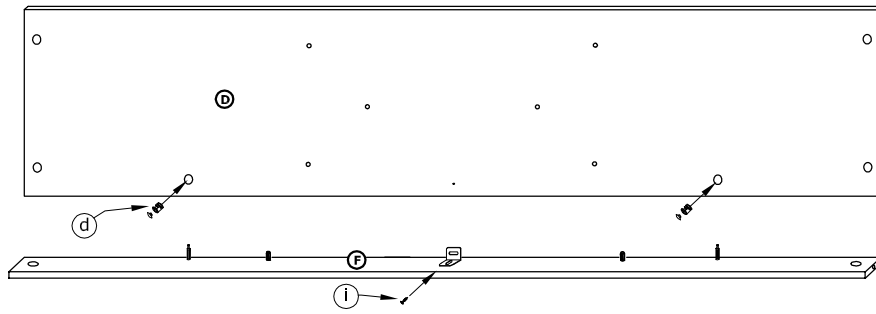

4

- | | |
|---|---|
| x 2 | x 1
(3,5x16) |
|  |  |
| (d) | (i) |



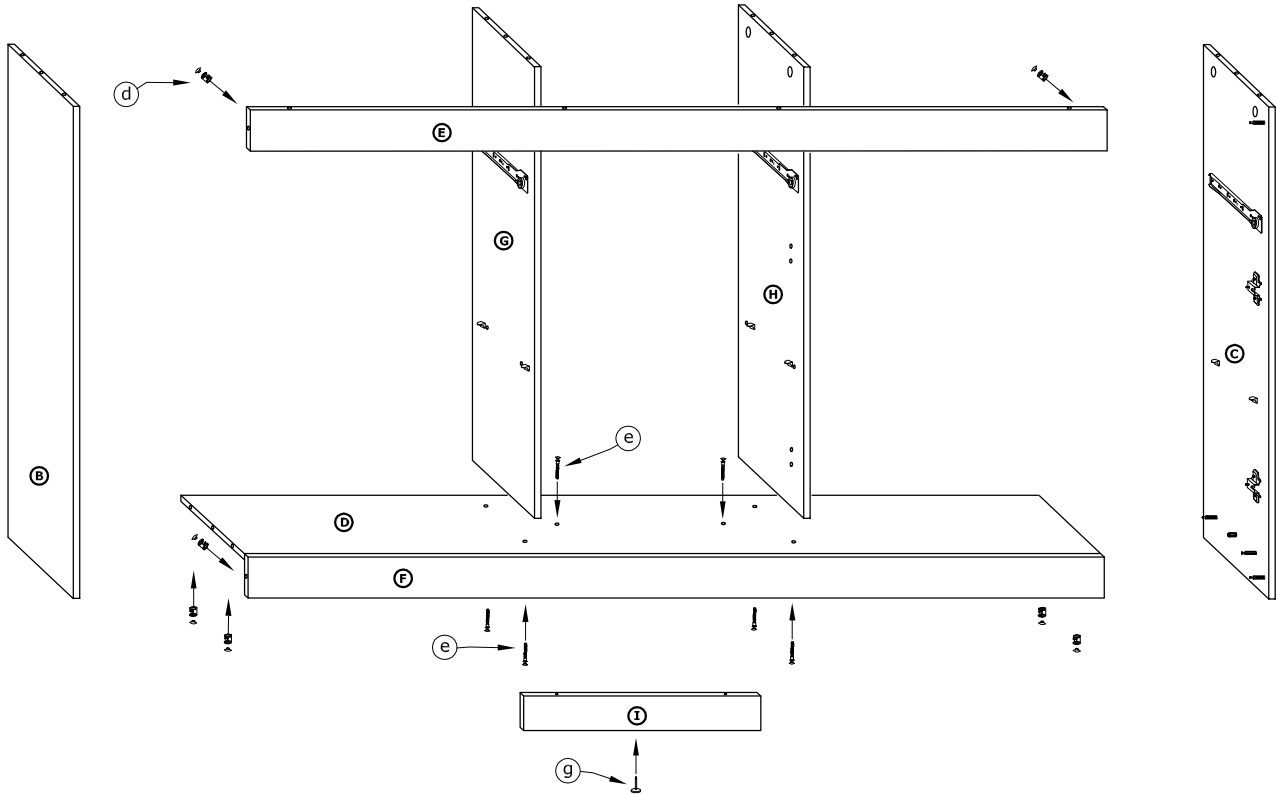

5

- | | | |
|---|---|---|
| x 8 | x 6 | x 1 |
|  |  |  |
| (d) | (e) | (g) |



6

- | |
|---|
| x 12 |
|  |
| (d) |
| x 2 |
|  |
| (g) |

