



# SVN-04 KOMODA 4S

→ 80 ↑ 89 ↘ 40



x 2 	x 4 	x 4 	x 28 						
x 8 (3x16) 	x 48 (3,5x16) 	x 20 (3,5x30) 	x 8 				x 4 	x 80 	x 1 
x 4 	x 4 kpl. (350 mm) 						 60 min 		

**1** - FAZY MONTAŻU

**A** - OZNACZENIE ELEMENTÓW

**a** - OZNACZENIE AKCESORIÓW

**1**

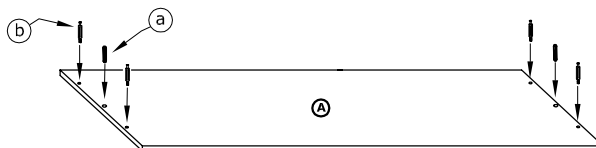
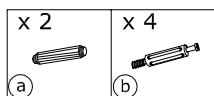

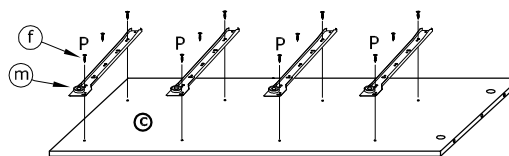
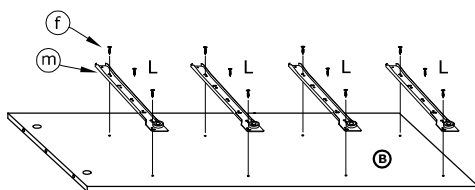
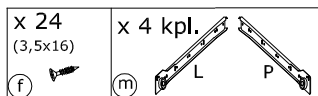

**2**

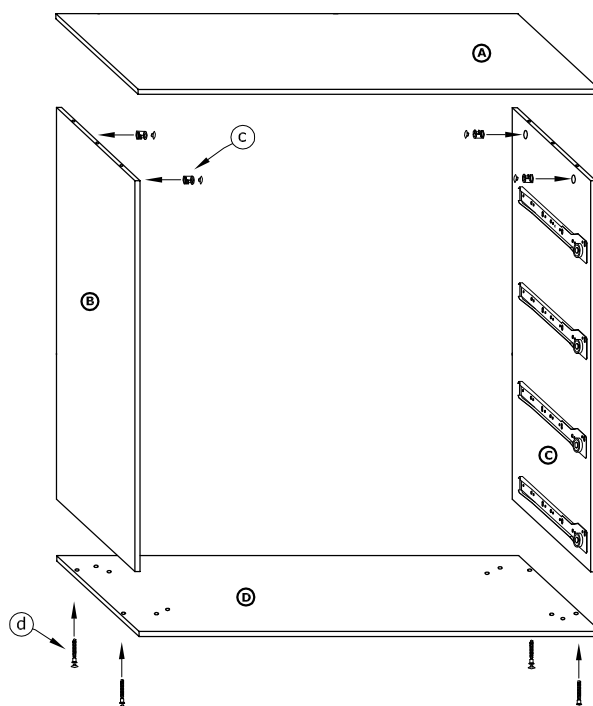
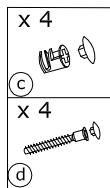

**3**







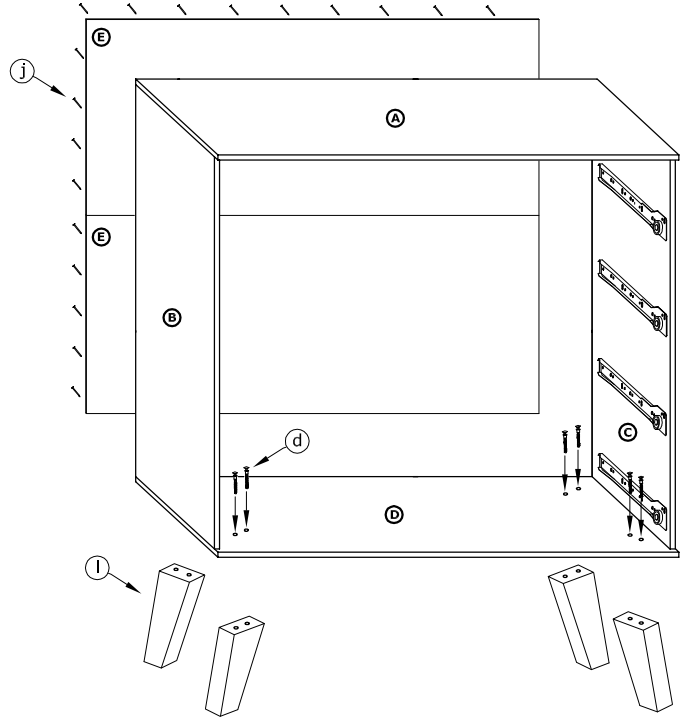



4

- x 8  

- x 20  

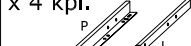
- x 4  

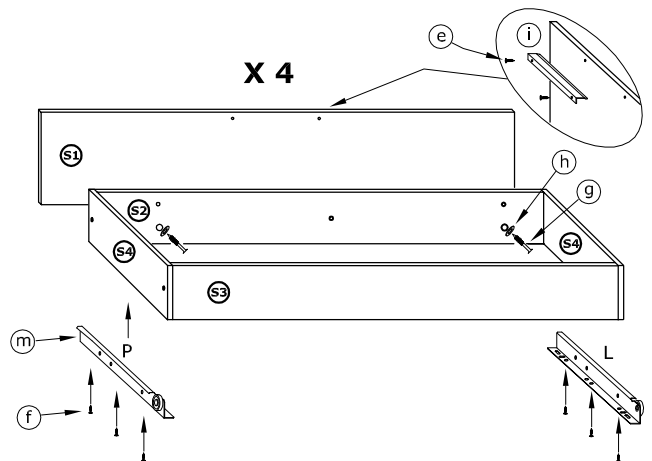
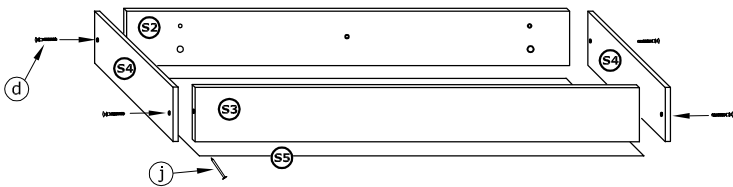

5

- |  |  |   |  |   |
|--|--|---|--|---|
| x 16<br> | x 8 (3x16)<br> | x 24 (3,5x16)<br>   | x 8 (3,5x30)<br> | x 8<br> |
| x 4<br> | x 60<br>      | x 4 kpl.<br>  |  |   |

X 4



6

- x 12 (3,5x30)  
