

A	B	C	D	
1	S404-1008	1178	428	1/3
2	S404-1009	1178	428	1/3
3	S404-1010	388	402	1/3
4	S404-1011	388	402	1/3
5	S404-1012	693	408	1/3
6	S404-2003	1491	454	2/3
7	S404-3003	1459	428	2/3
8	S404-3004	945	407	1/3
9	S404-3005	496	407	1/3
10	S404-3006	1459	393	2/3
11	S404-4003	1459	160	2/3
12	S404-4004	1459	60	2/3
13	S404-5005	1350	70	2/3
14	S404-5006	1350	70	2/3
15	S404-5007	1178	70	1/3
16	S404-5008	1178	70	1/3
17	S404-5050	432	398	3/3
18	S404-5051	495	398	3/3
19	S404-5052	208	446	3/3
20	S404-9004	1106	509	1/3
21	S404-9303	1106	959	1/3
23	S407-0005	543	446	3/3
22	S407-0004	543	446	3/3
24	S407-0006	518	446	3/3
25	S407-0012	446	145	3/3
26	S407-0013	446	145	3/3
27	S407-0014	446	120	3/3
28	S407-0015	446	120	3/3
29	S407-0016	446	120	3/3

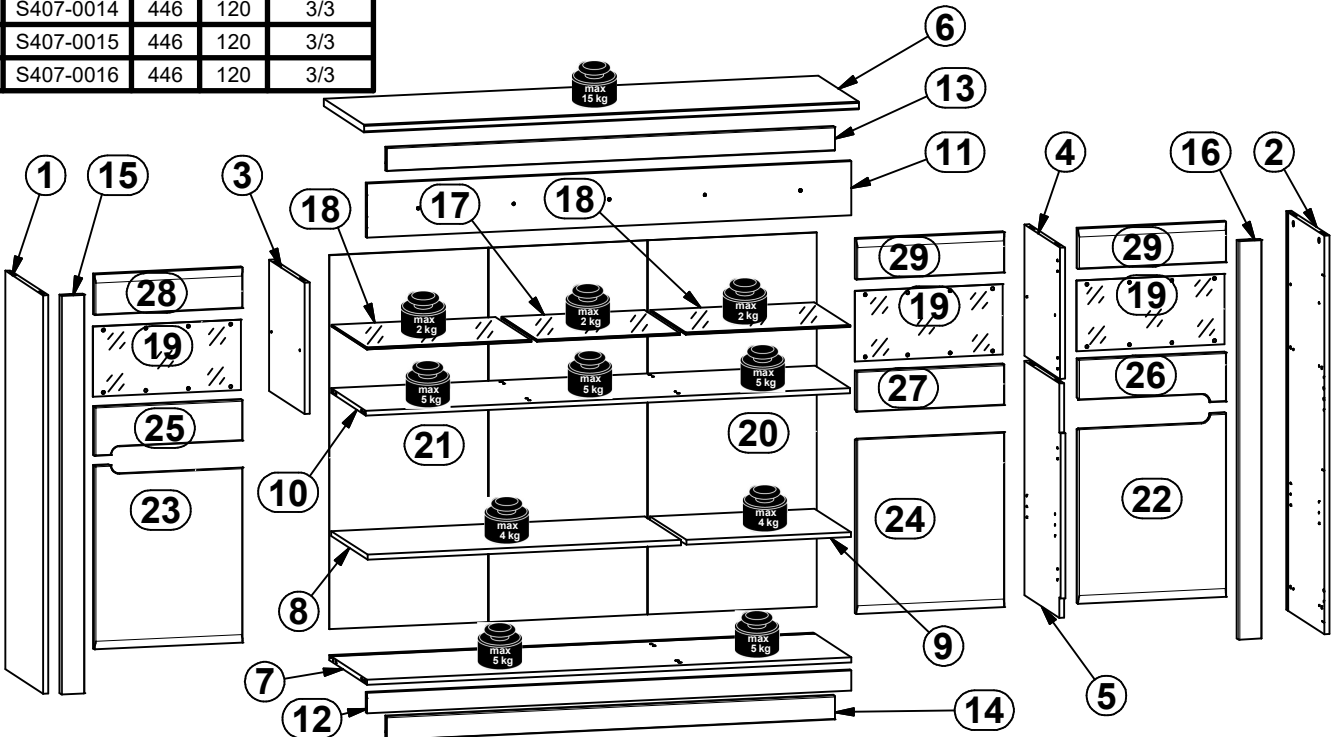

8x a132	6x a133	4x a159	12x b43	8x d1	12x d3	1x d36	9x d37	2x e1
25x e2	24x e41	3x e45	30x f1	2x f13	4x k1	1x k38l3	1x k38l8	12x l2
5x n108	24x o54	42x p38	24x p51	5x p55	28x r1	28x r42	12x s2	1x z1
							1x n26l1	1x p38

1 §2

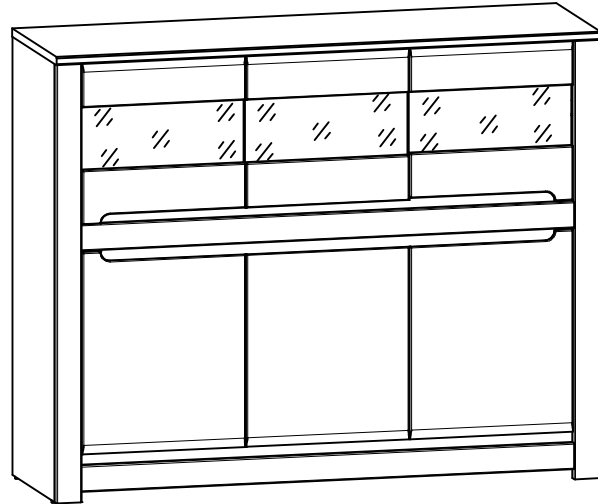
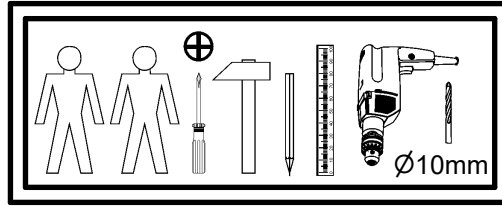
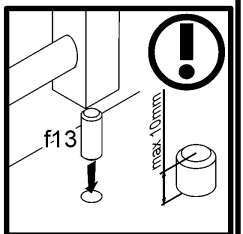
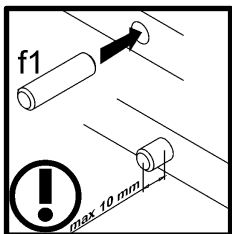
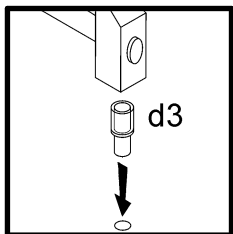
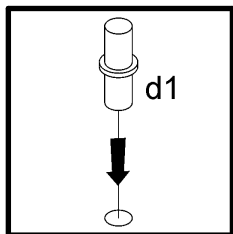
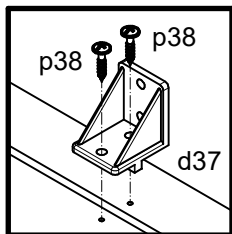
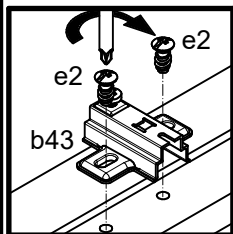
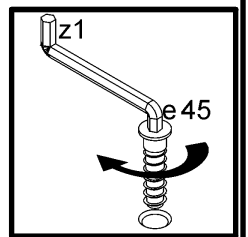
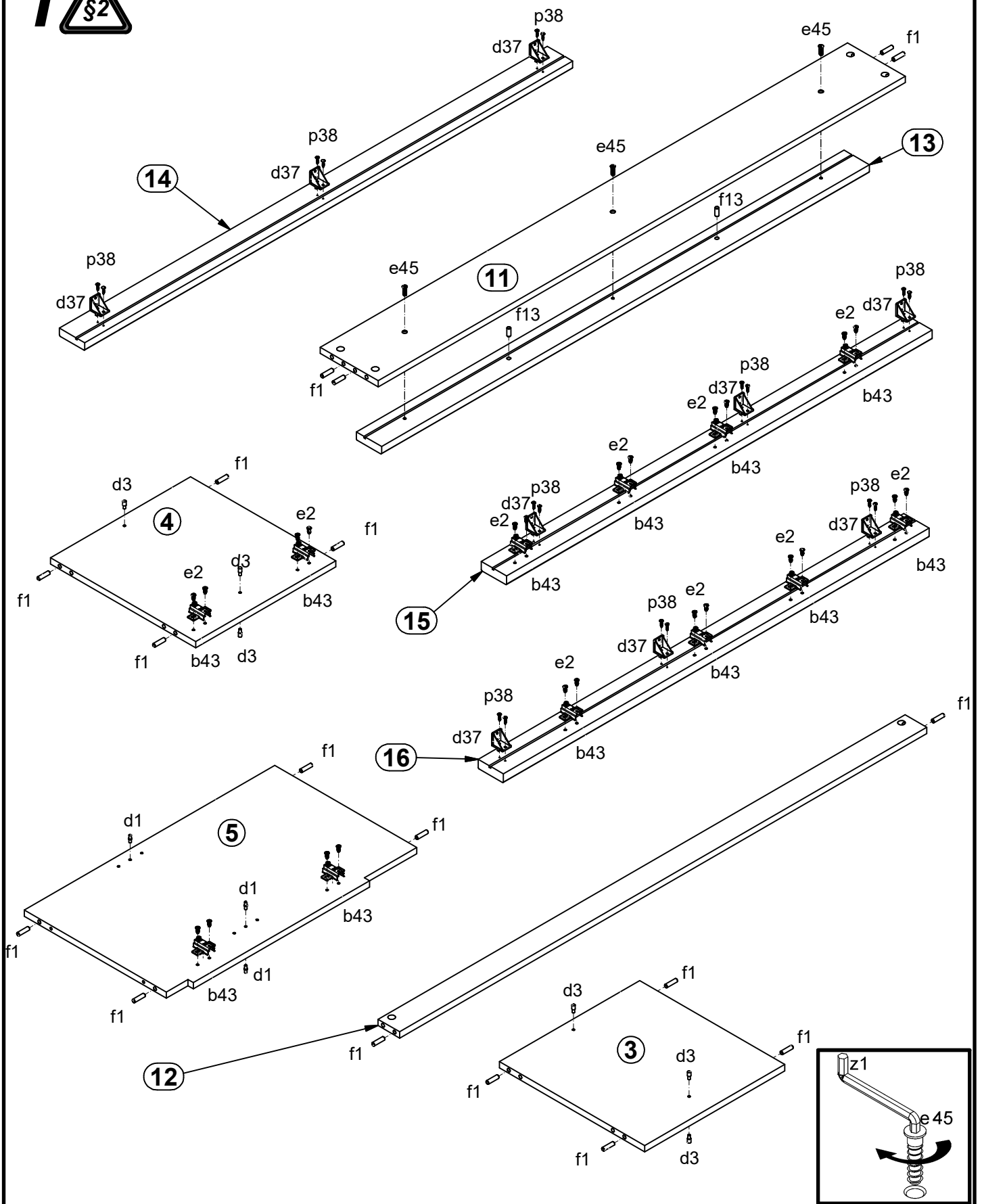

2

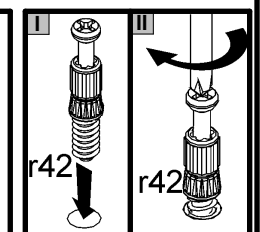
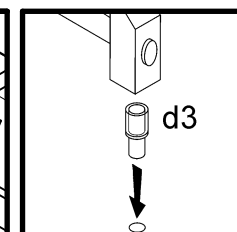
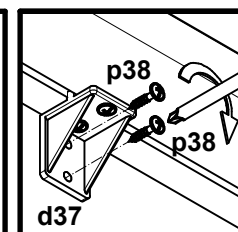
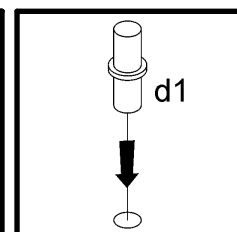
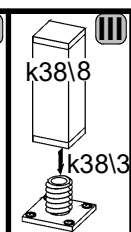
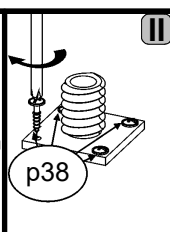
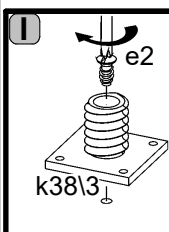
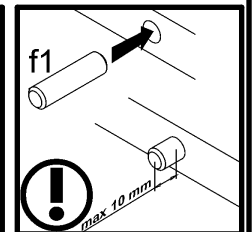
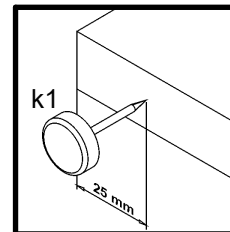
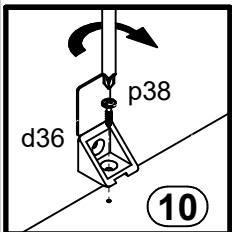
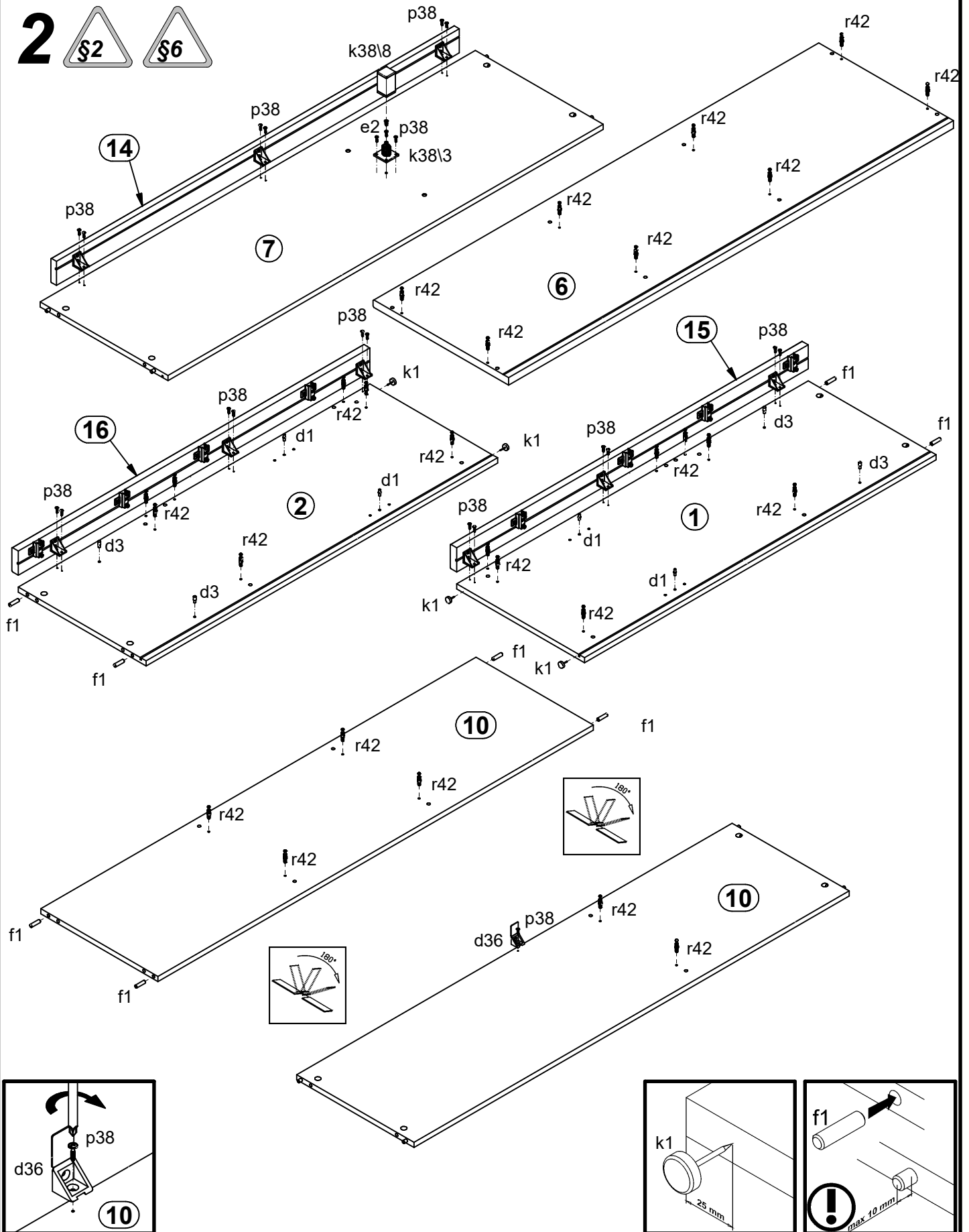

3

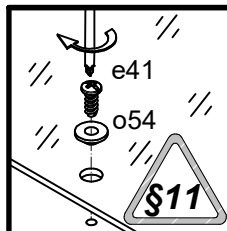
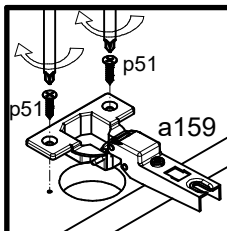
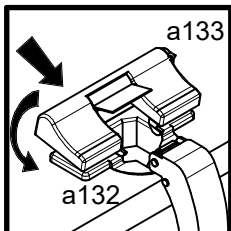
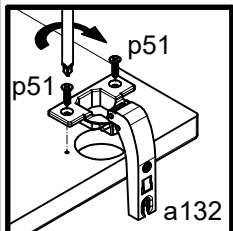
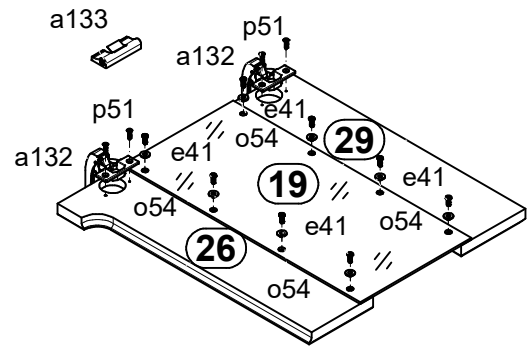
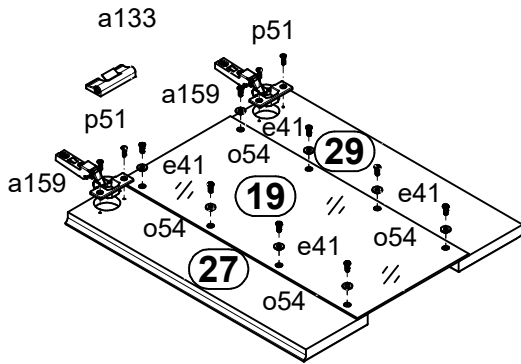
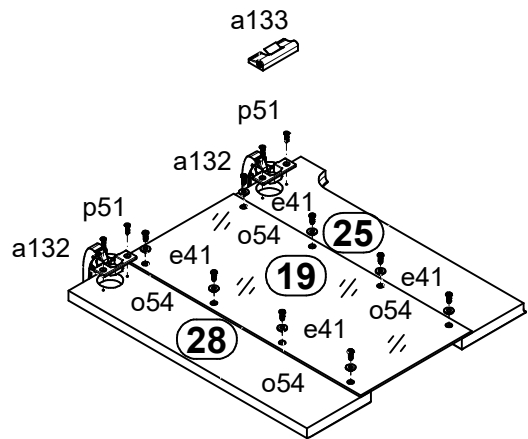
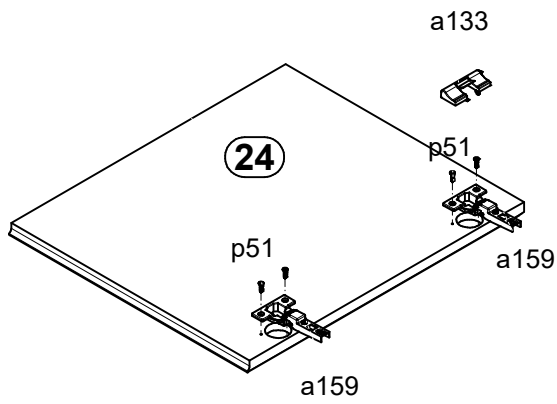
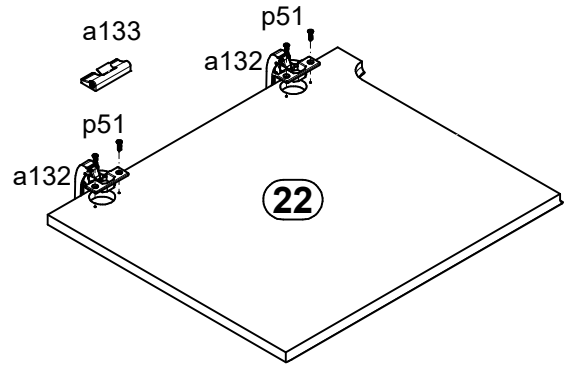
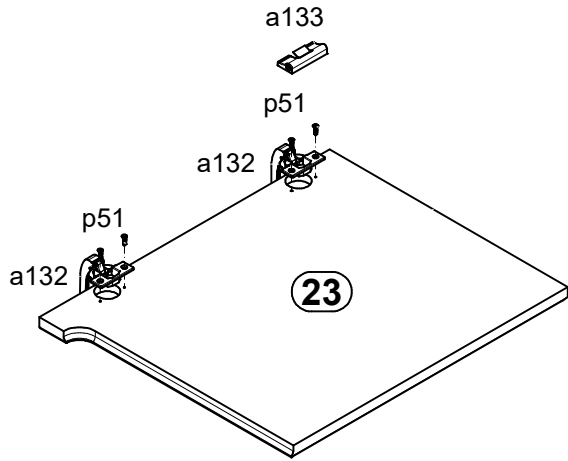

4 §6

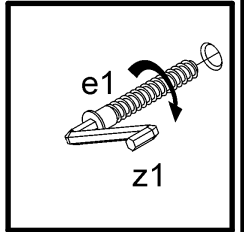
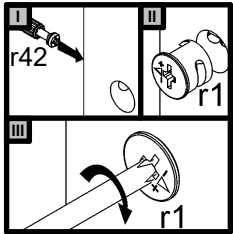
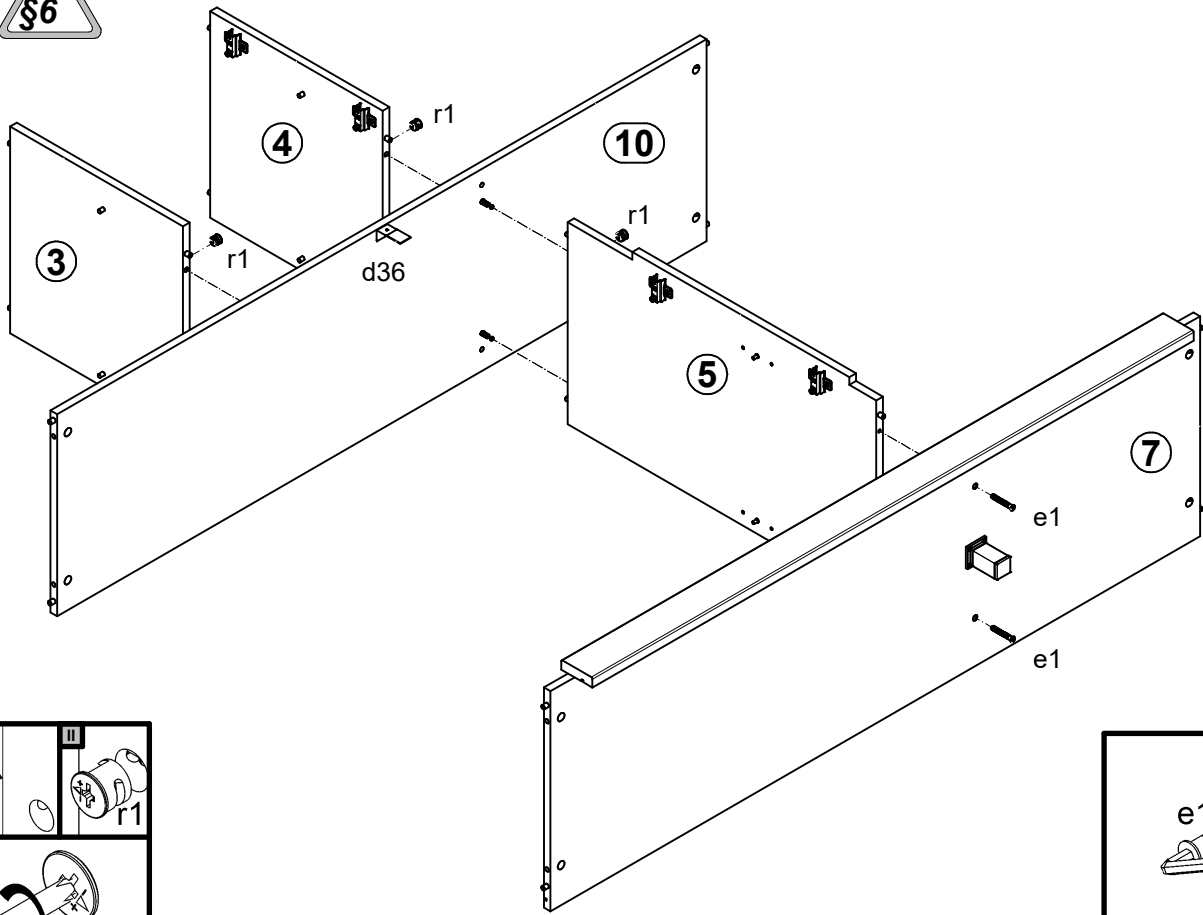

5

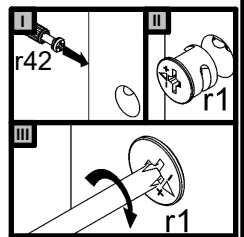
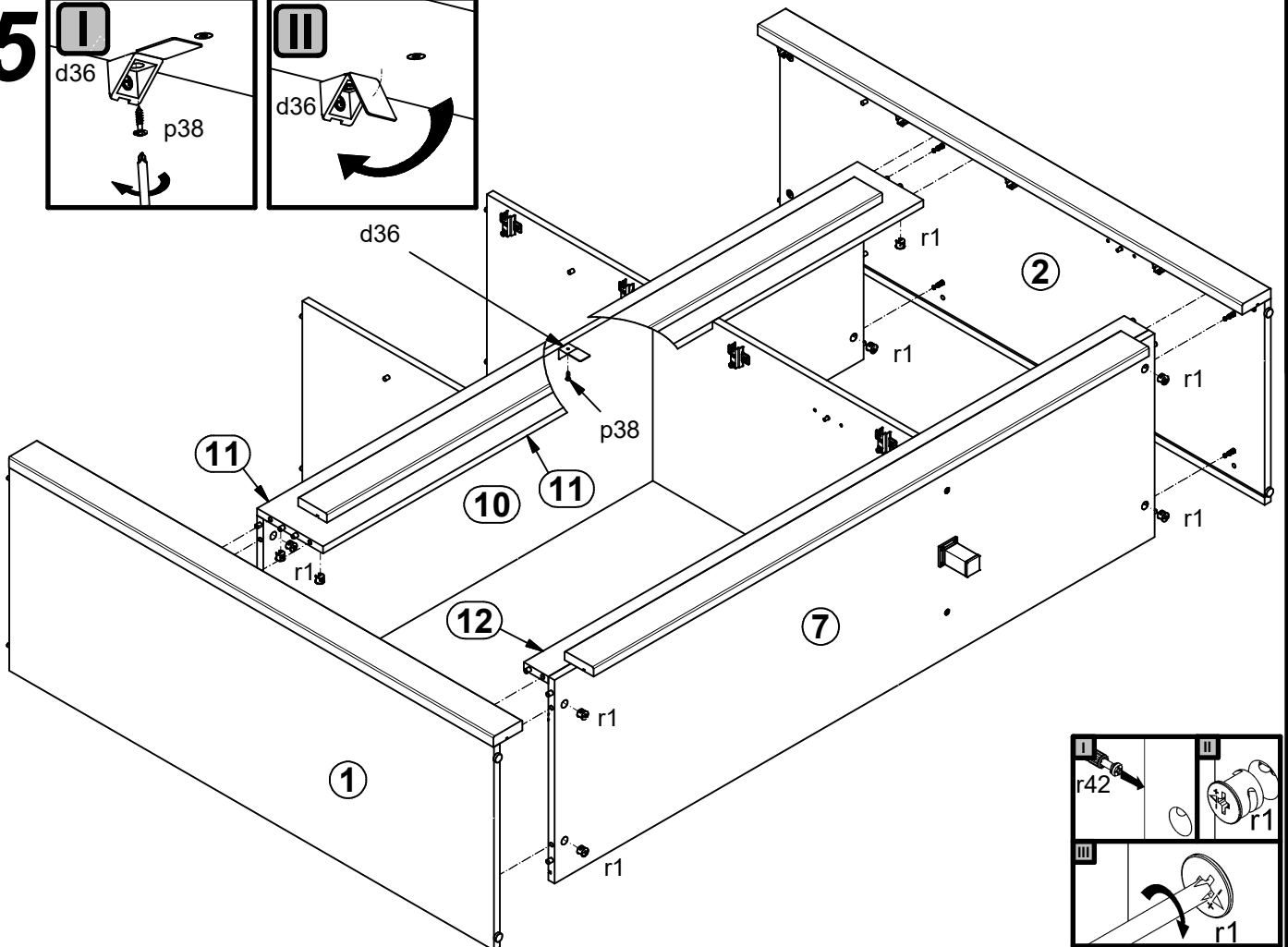
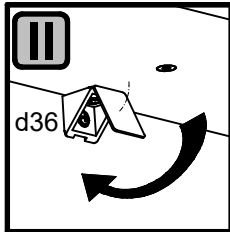
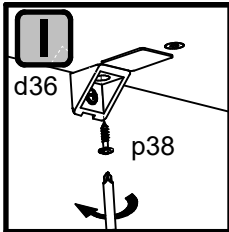

6

§6

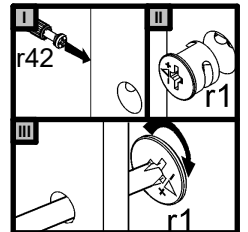
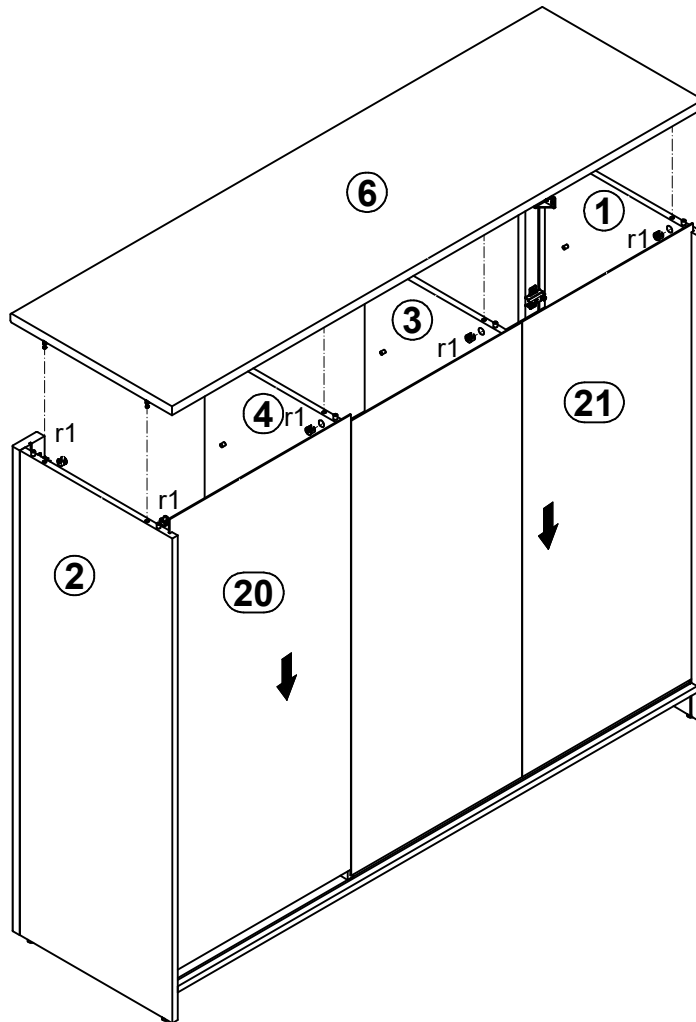

7

§6

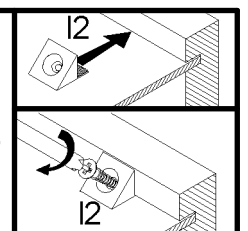
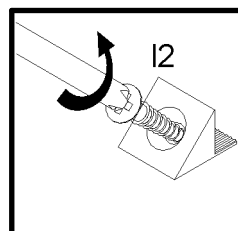
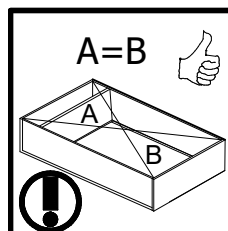
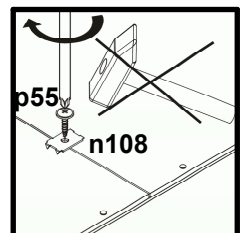
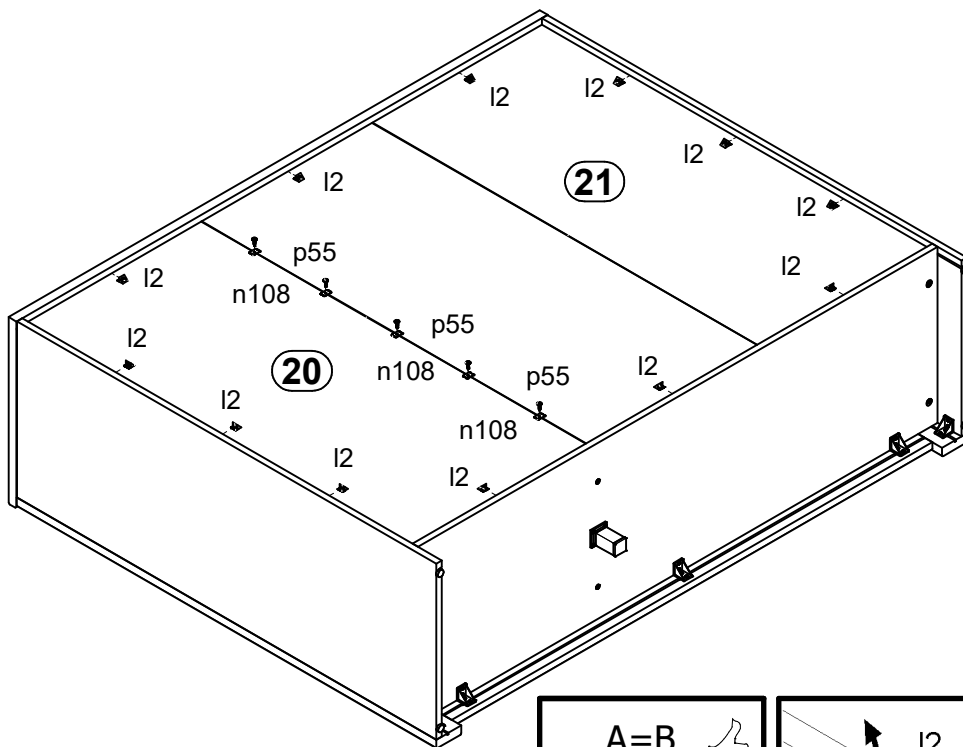

8

