

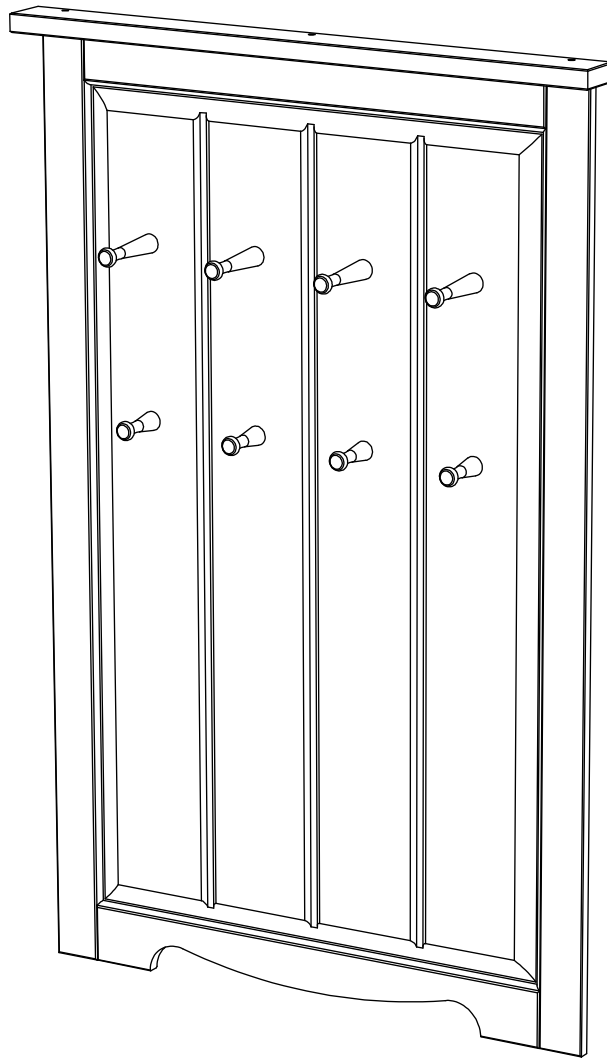

# Art. Nr. 29820165, 50847411

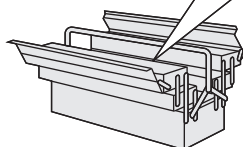

- |           |                                    |           |                                |
|-----------|------------------------------------|-----------|--------------------------------|
| <b>D</b>  | <b>Montageanleitung</b>            | <b>GB</b> | <b>Assembly instructions</b>   |
| <b>FR</b> | <b>Notice de montage</b>           | <b>IT</b> | <b>Istruzioni di montaggio</b> |
| <b>NL</b> | <b>Handleiding voor de montage</b> | <b>PL</b> | <b>Instrukcja montażu</b>      |
| <b>CZ</b> | <b>Montážní návod</b>              | <b>SK</b> | <b>Návod na montáž</b>         |
| <b>HU</b> | <b>Szerelési útmutató</b>          | <b>RO</b> | <b>Instrucțiuni de montaj</b>  |
| <b>TR</b> | <b>Montaj talimatı</b>             | <b>RU</b> | <b>Инструкция по монтажу</b>   |

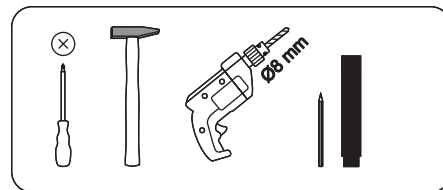
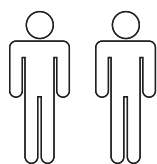

0  
10  
20  
30  
40  
50  
60  
70  
80  
90  
100  
110  
120  
130  
140  
150  
160  
170  
180  
190  
200

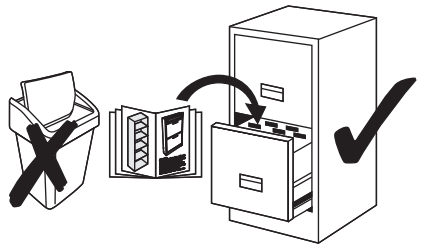
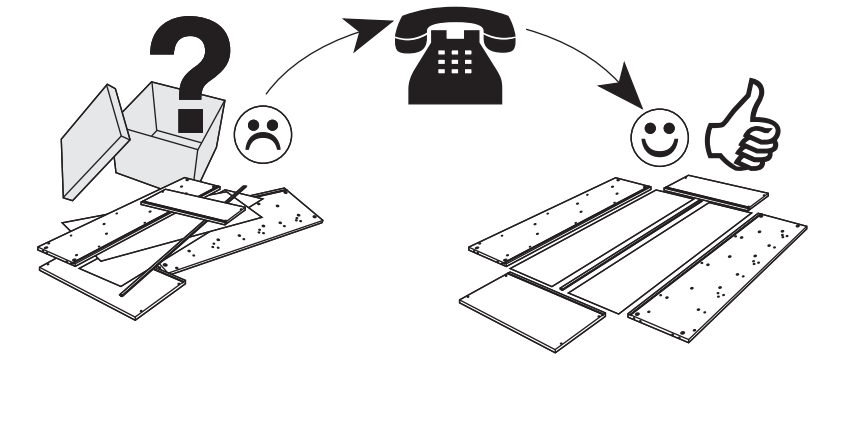
Service • Assistenza • Dienstverlening • Serwis Servis • Szerviz • Сервисная служба	
Name • Nom • Nome • Naam • Nazwa • Jméno • Názov • Név • Denumire • İsim • Название	
Nr. • No. • N° • Номер • Č • Sz <b>29820165, 50847411</b>	
Typ • Type • Tip • Típus • Tipo • Тип	
	
	

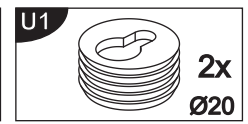
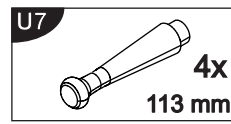
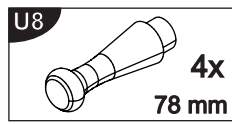
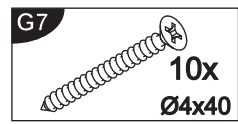
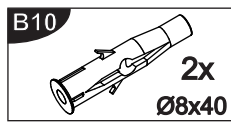
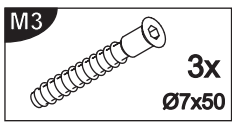
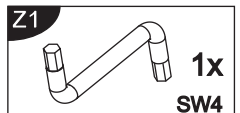
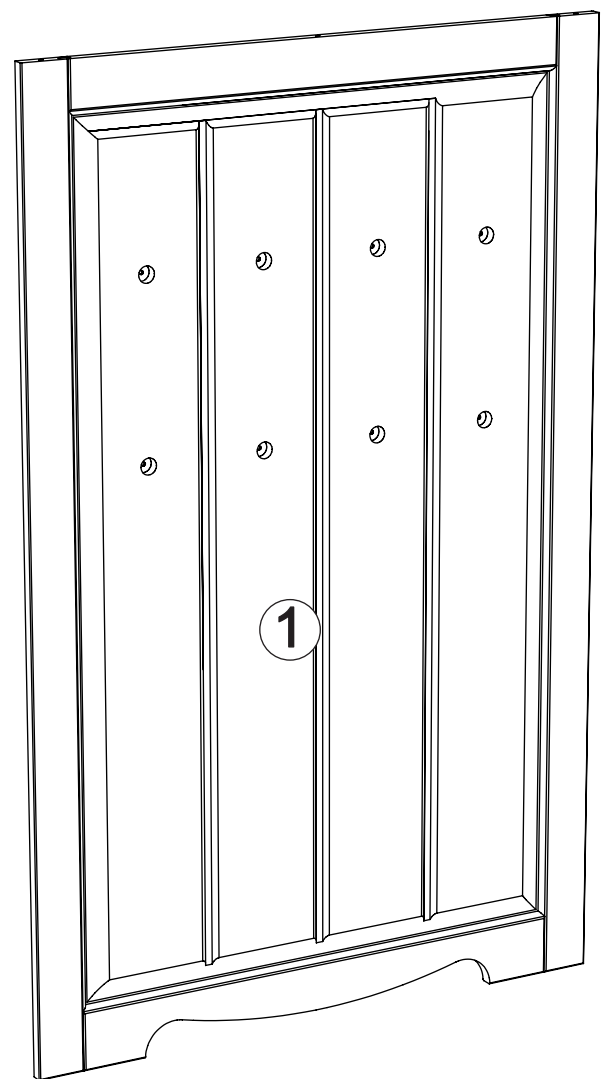

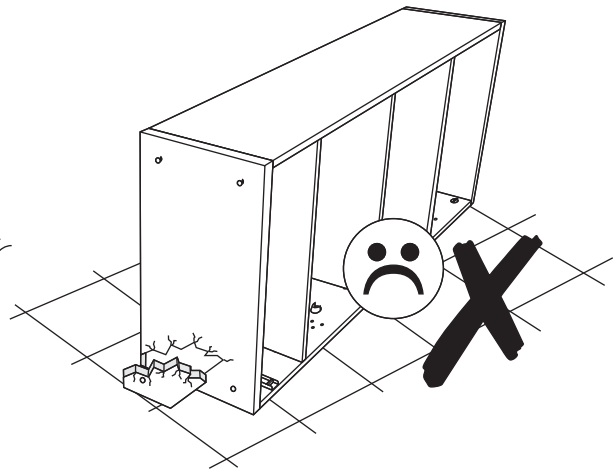

1

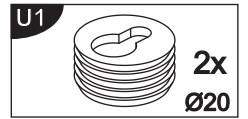
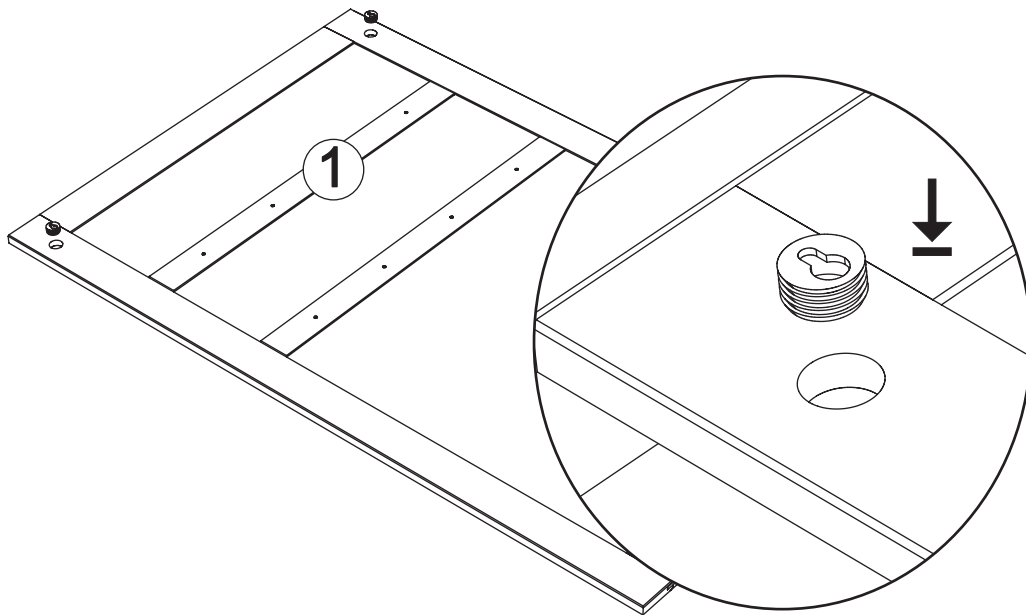

2

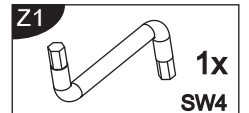
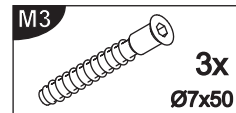
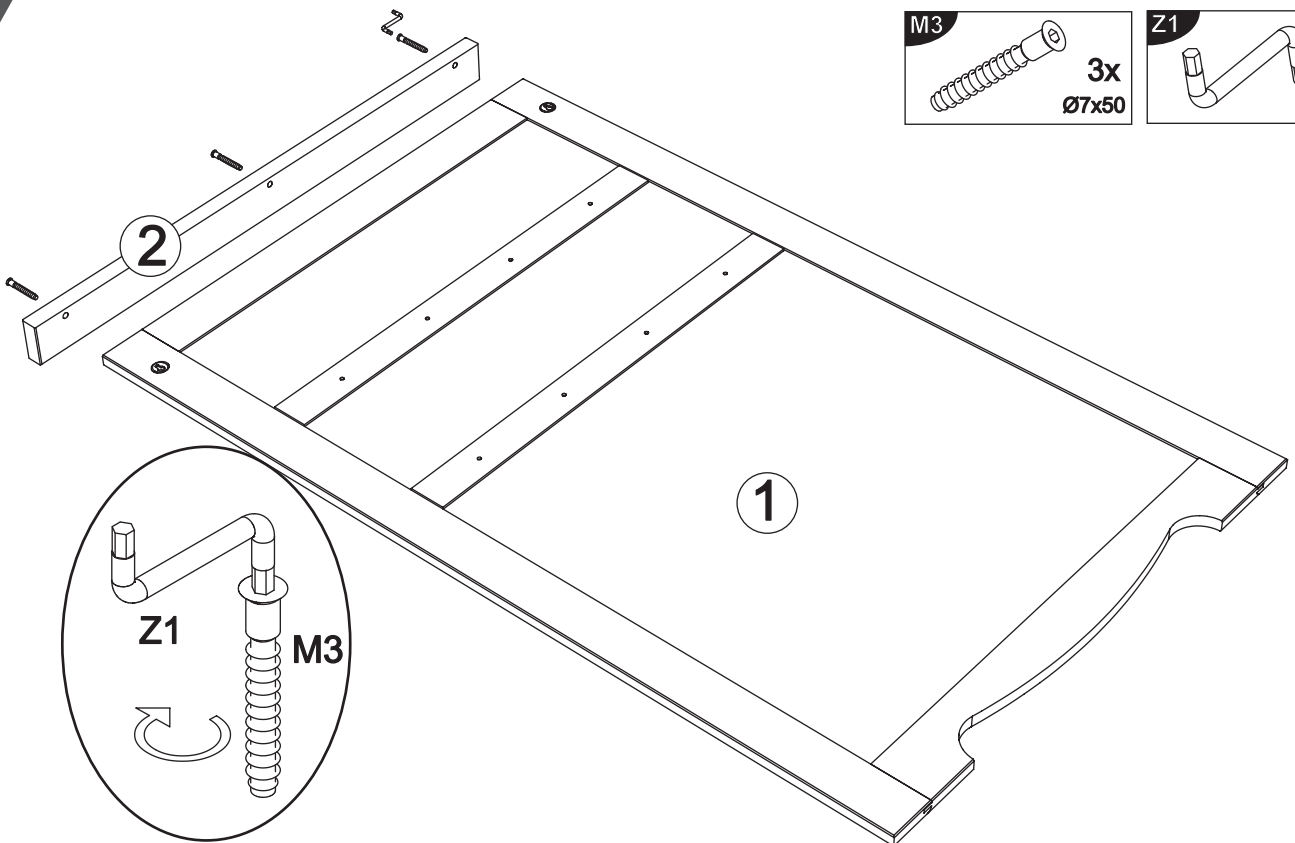

3

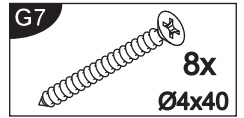
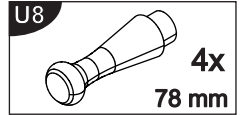
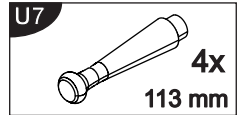
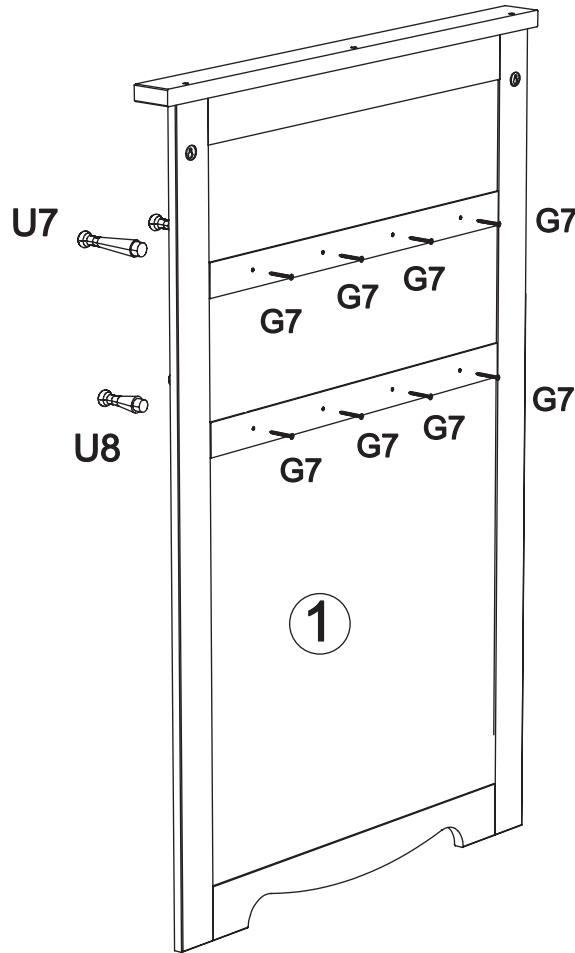

4

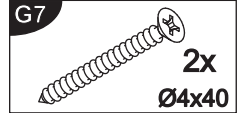
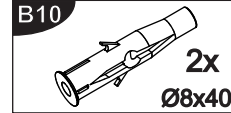
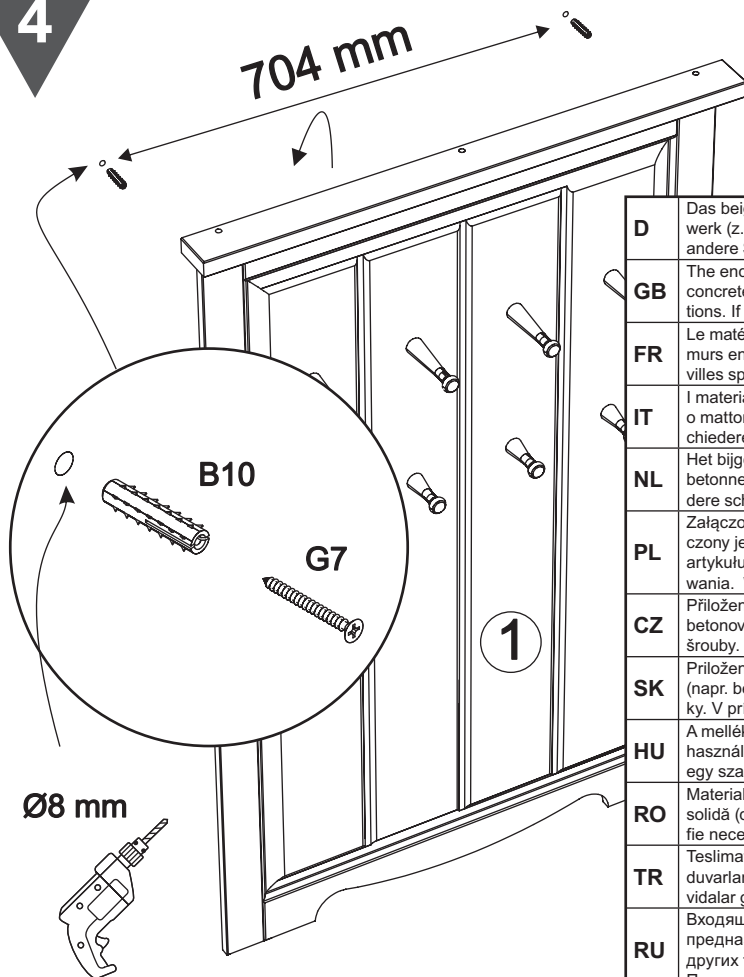

<b>D</b>	Das beigefügte Wandbefestigungsmaterial (Dübel und Schrauben) eignet sich nur für festes Mauerwerk (z.B. Beton- oder Ziegelwände). Für andere Wandaufbauten sind eventuell Spezialdübel und andere Schrauben notwendig. Ziehen Sie gegebenenfalls eine Fachkraft zurate.
<b>GB</b>	The enclosed wall mounting materials (dowels and screws) are only suitable for solid masonry (e. g. concrete or brick walls). Special dowels and other screws may be necessary for other wall constructions. If necessary, please consult a qualified professional.
<b>FR</b>	Le matériel de fixation murale fourni (chevilles et vis) convient uniquement à des murs solides (p. ex. murs en béton ou en briques). Pour les autres constructions de murs, il faut éventuellement des chevilles spéciales et d'autres vis. Faites-vous conseiller par un spécialiste.
<b>IT</b>	I materiali di fissaggio allegati (tasselli e viti) sono adatti solo ai muri compatti (ad es. di calcestruzzo o mattoni). Per altri tipi di pareti è probabile che occorrano tasselli speciali e altre tipologie di viti. Richiedete eventualmente il consiglio di un esperto.
<b>NL</b>	Het bijgeleverde bevestigingsmateriaal (pluggen en schroeven) is geschikt voor vaste muren (bijv. betonnen of bakstenen muren). Voor andere muurconstructies zijn eventueel speciale pluggen en andere schroeven noodzakelijk. Consulteer eventueel een vakman.
<b>PL</b>	Załączony zestaw montażowy do zamocowania artykułu do ściany (kołki, wkręty, haki itp.), przeznaczony jest wyłącznie do montażu artykułu na ścianach wykonanych z cegły lub betonu. Przy montażu artykułu na ścianie wykonanej z innych materiałów, należy zastosować odpowiednie do niej zamocowania. W razie wątpliwości prosimy zasięgnąć porady fachowca.
<b>CZ</b>	Přiložený materiál pro montáž na stěnu (hmoždinky a šrouby) je vhodný jen pro pevné zdivo (např. betonové nebo cihlové stěny). Pro jiné skladby stěn budou případně nutné speciální hmoždinky a jiné šrouby. Poradte se případně s odborníkem.
<b>SK</b>	Priložený materiál pre upevnenie na stenu (hmoždinky a skrutky) je vhodný len pre pevné murivo (napr. betónové alebo tehlové steny). Pre iné steny sú potrebné príp. špeciálne hmoždinky a iné skrutky. V prípade potreby sa poradte s odborníkom.
<b>HU</b>	A mellékelt fal rögzítőkészlet (tiplí és csavarok) csak tömött falazatban (pl. betonfalban, téglafalban) használható. Más faltípusokhoz speciális tiplire és csavarra lesz szükség. Szükség esetén kérje ki egy szakember véleményét.
<b>RO</b>	Materialul furnizat pentru montajul de perete (dibluri și șuruburi) este adecvat numai pentru zidărie solidă (de exemplu pereți din beton sau din cărămidă). Pentru alte structuri de pereți, este posibil să fie necesare dibluri speciale, precum și alte șuruburi. Dacă este necesar, consultați un specialist.
<b>TR</b>	Teslimat kapsamındaki duvar tipi sabitleme materyali (dübel ve vidalar) sadece beton ve tuğla duvarlar gibi sağlam duvar yapıları için uygundur. Başka duvar yapıları için özel dübelleri veya başka vidalar gerekli olabilir. Gerekirse bir uzmandan yardım alın.
<b>RU</b>	Входящий в комплект поставки материал для крепления на стене (дюбели и болты) предназначен только для прочных каменных стен (например, бетонных или кирпичных). Для других типов стен используйте по мере необходимости специальные дюбели и другие болты. По мере необходимости обратитесь за помощью к специалистам.