

Housebed S

70 x 140 cm



Assembly instructions



RIVERBANK

general information

Certificate of origin.

Congratulations with the purchase of this piece of furniture made from solid wood. This piece of furniture made by woodcraftsmen, is produced from selected pinewood. Diligents and colour differences are not mistakes or imperfections, but characteristic for solid wood.

Echtheits- Zertifikat.

Glückwunsch zum Kauf dieses Möbelstückes aus Massivholz. Dieses Möbelstück von Fachleuten hergestellt, ist produziert aus aussortiertem Kieferholz. Risse und verschiedene Farben im Holz sind keine Fehler, sondern Kennzeichen für Massivholz.

Certificaat van echtheid.

Gefeliciteerd met de aankoop van dit meubel, gemaakt van massief hout. Dit meubel, gemaakt door vakmensen, is geproduceerd uit geselecteerd grenen hout. Noesten en kleurverschillen zijn geen fouten of onvolkomenheden, maar kenmerkend voor massief hout.

Certificat d'authenticité.

Félicitations avec l'achat de ce meuble en bois massif. Ce meuble a été réalisé par des professionnels. Les loupes et les différences de tons dans le bois ne sont pas des erreurs ou des imperfections, mais au contraire caractéristiques pour le bois massif.

General points for self-building furniture.

- 1) Always first read the manual carefully before you commence building-up.
- 2) Sort out all parts and check if everything is there.
- 3) Make enough space free to mount the furniture and work as close as possible to the place where the furniture is going to be situated.
- 4) Use the carton package as an underlayer to prevent damages while building-up.- fig.1
- 5) When making connections with dowels (wooden pins) , always put the dowels in the headside of the wood. Push or hammer the dowels carefully into the predrilled holes as far as possible.- fig.2

Algemeine hinweise zur montage von Selbstbaumöbeln.

- 1) Lesen Sie zuerst die Anleitung genau durch, bevor Sie mit dem Zusammenbau anfangen.
- 2) Suchen Sie alle Einzelteile übersichtlich zusammen und kontrollieren Sie, ob all Einzelteile mitgeliefert worden sind.
- 3) Schaffen Sie genügend Platz, um das Möbelstück zusammenbauen zu können, und arbeiten Sie möglichst nahe an der Stelle, wo es nach dem Zusammenbau aufgestellt wird.
- 4) Benutzen Sie eventuell die Verpackung als Unterlage, um Beschädigungen während des Zusammenbaus zu verhindern.- fig.1
- 5) Zu Verbindungen mit Hilfe von Zapfen (Holzstiften) sind die Zapfen immer mit der Kopfseite nach vorne anzubringen. Klopfen Sie behutsam die Zapfen möglichst tief in die vorgebohrten Löcher.- fig.2

Algemene aanwijzingen voor zelfbouwmeubelen.

- 1) Lees altijd eerst de handleiding goed door voordat u met de montage begint.
- 2) Sorteert alle onderdelen overzichtelijk bij elkaar en controleer of alles aanwezig is.
- 3) Maak voldoende ruimte vrij om het meubel te monteren en werk zo dicht mogelijk bij de plek waar het gemonteerde meubel moet komen te staan
- 4) Gebruik eventueel de verpakking als ondergrond om beschadigen tijdens het monteren te voorkomen.- fig.1
- 5) Voor verbindingen met behulp van deuvels (houten pennen) dienen de deuvels altijd in de kopse kanten te worden aangebracht. Tik de deuvels voorzichtig zo ver mogelijk in de voorgeboorde gaten.- fig.2

Indices généraux d'assemblage pour les meubles en kit.

- 1) Commencez toujours par lire attentivement le mode d'emploi avant l'assemblage.
- 2) Triez toutes les pièces détachées de façon bien ordonnée et vérifiez si tout est là.
- 3) Dégagez un endroit assez spacieux pour le montage du meuble et tant que possible, assemblez aussi près de l'endroit où vous voulez le mettre finalement.
- 4) Utilisez éventuellement l'emballage comme base pendant l'assemblage, afin d'éviter l'endommagement de l'article.- fig.1
- 5) L'assemblage à l'aide des tenons se fait toujours en positionnant les tenons dans le côté de dessus.- fig.2

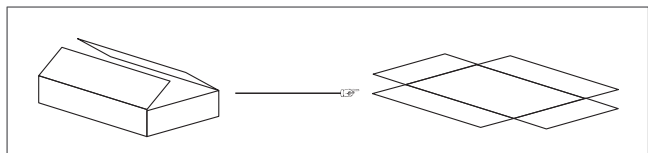

fig. 1

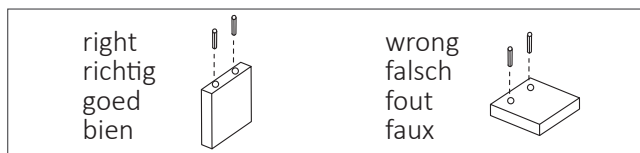
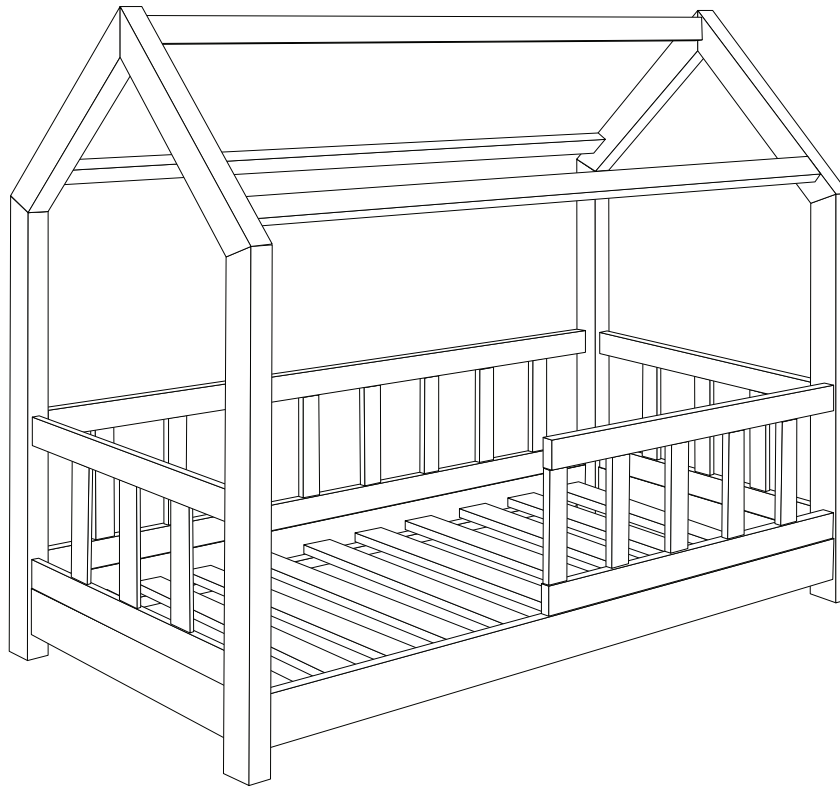
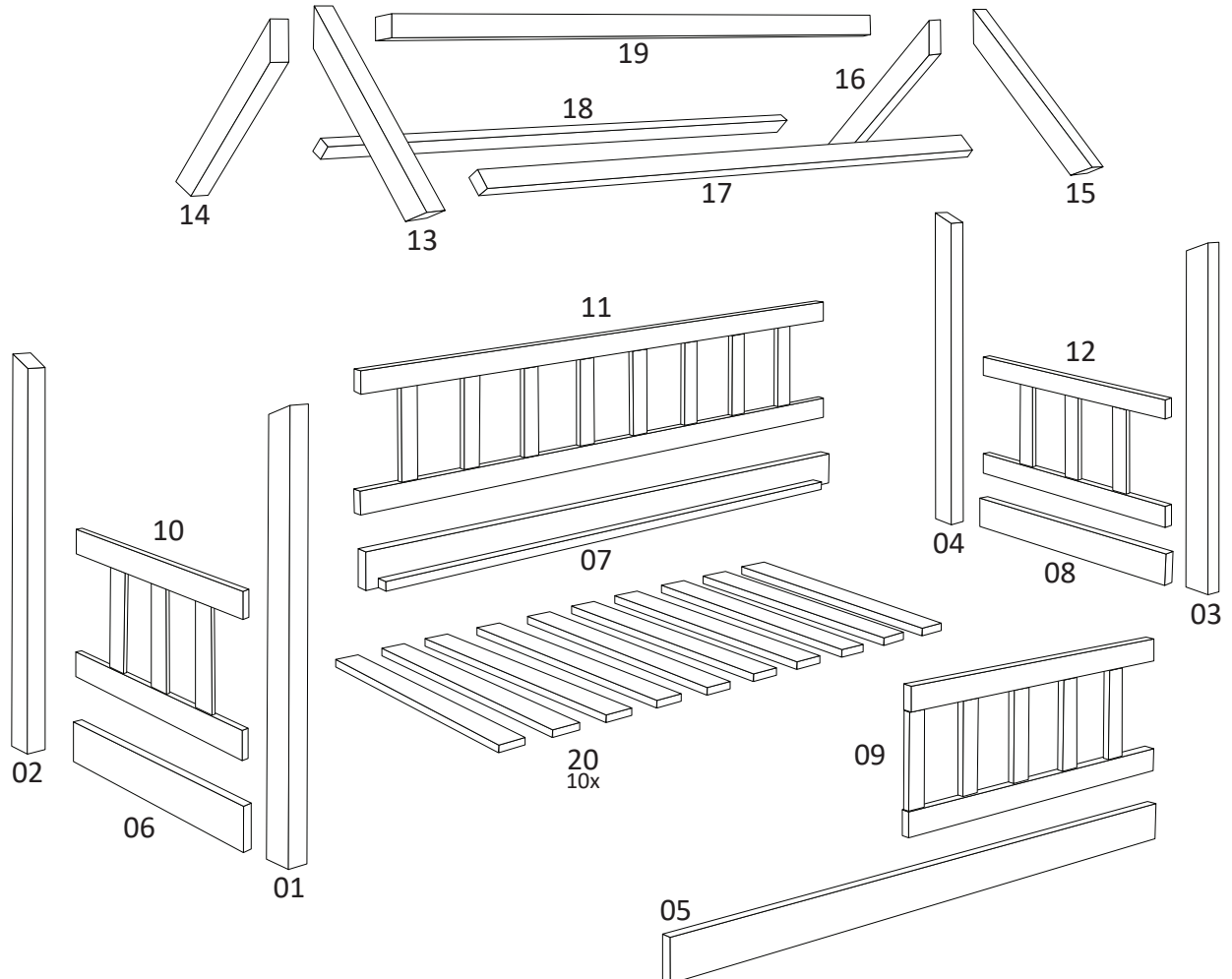

fig. 2

product view



exploded view | part nr.



fittings list | fitting nr.

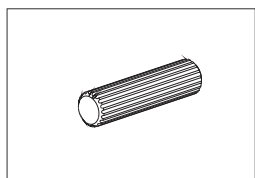

A
8 x 40 mm
35 pcs

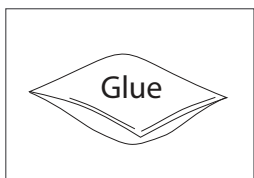

B
optional

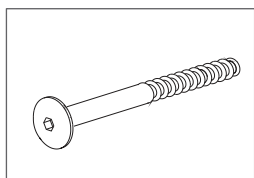

C
6 x 80 mm
4 pcs

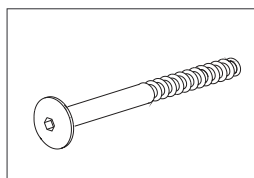

D
6 x 105 mm
4 pcs

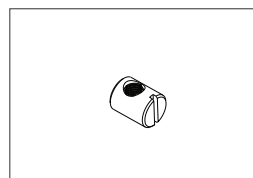

E
M6 x 10 x 13 mm
8 pcs

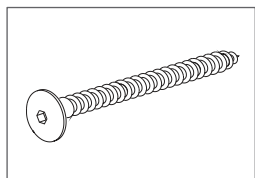

F
6,3 x 80 mm
13 pcs

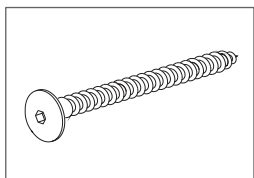

G
6,3 x 105 mm
4 pcs

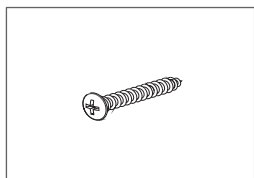

H
3,5 x 40 mm
20 pcs

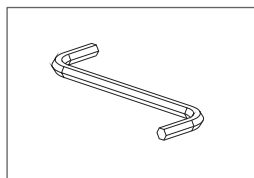

I
M4
1 pc

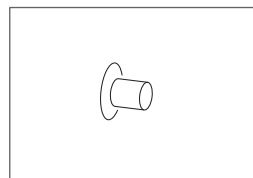

J
M8
3 pcs

needed for assembly:

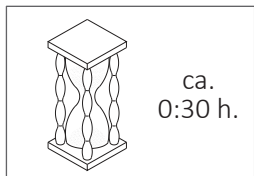
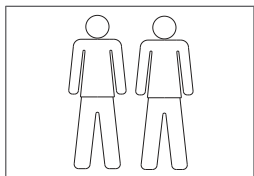
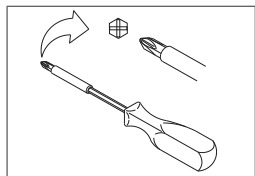

ca.
0:30 h.

step 01

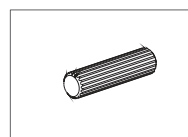
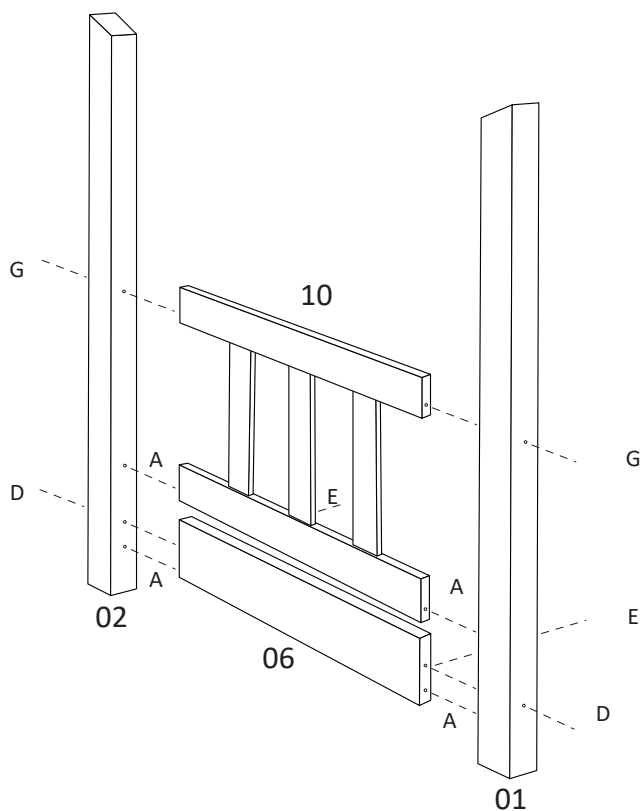

A
8 x 40 mm
4 pcs

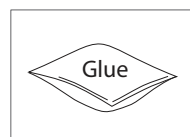

B
optional

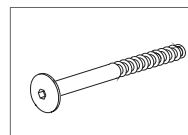

D
6 x 105 mm
2 pcs

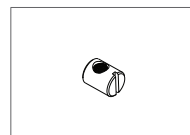

E
M6 x 10 x 13 mm
2 pcs

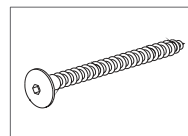

G
6,3 x 105 mm
2 pcs

step 02

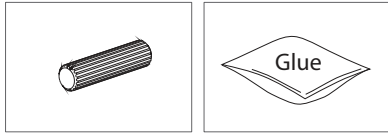

A
8 x 40 mm
4 pcs

B
optional

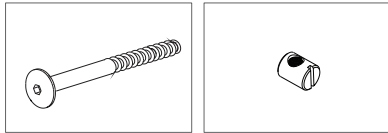

D
6 x 105 mm
2 pcs

E
M6 x 10 x 13 mm
2 pcs

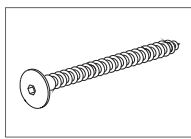

G
6,3 x 105 mm
2 pcs

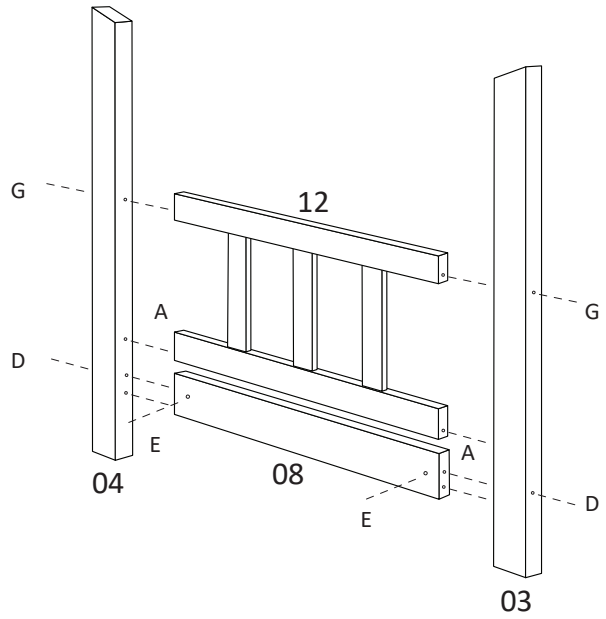

step 03

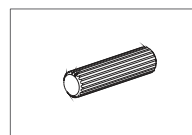
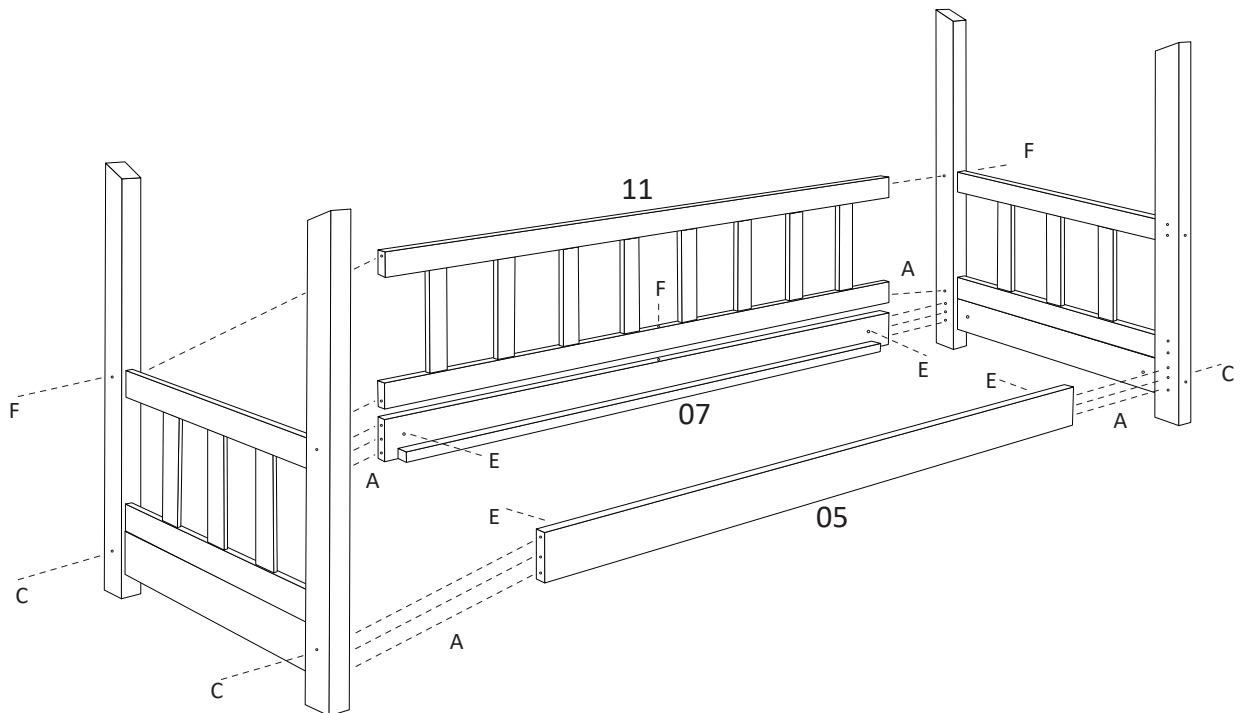

A
8 x 40 mm
10 pcs

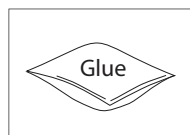

B
optional

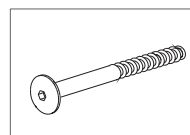

C
6 x 80 mm
4 pcs

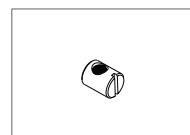

E
M6 x 10 x 13 mm
4 pcs

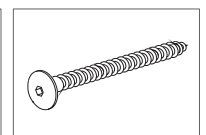

F
6,3 x 80 mm
3 pcs

step 04

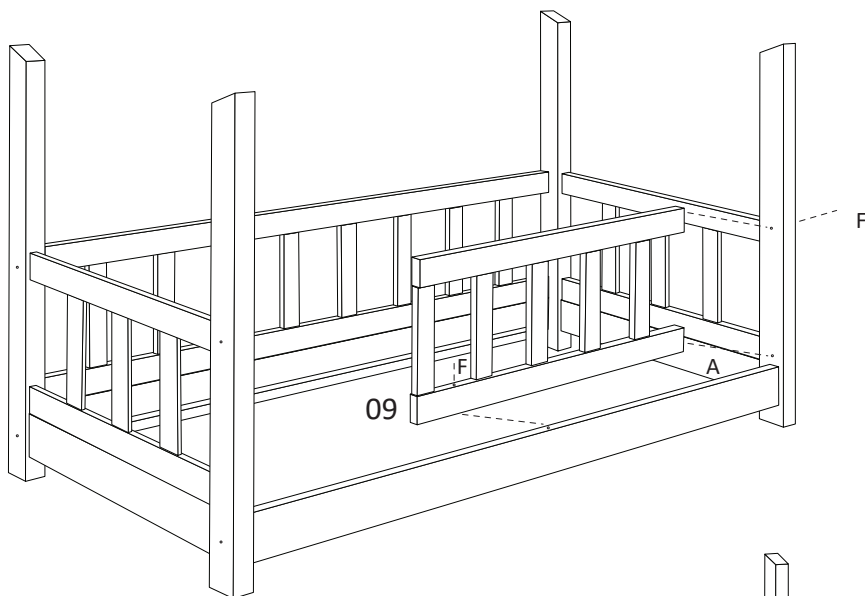

Mounting of part 09
optionally right or left.
Montage von Teil 09
wahlweise rechts oder links.

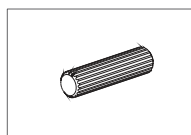

A
8 x 40 mm
1 pc

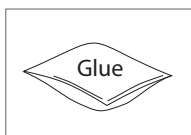

B
optional

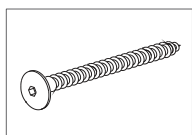

F
6,3 x 80 mm
2 pcs

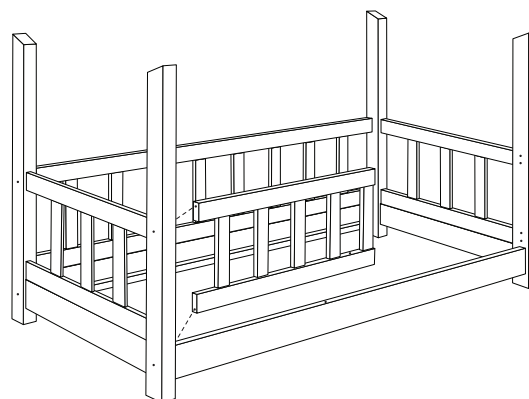

step 05

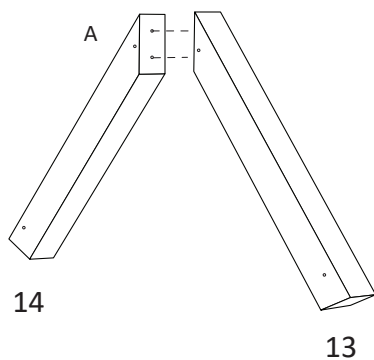

14

13

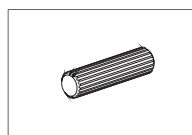

A
8 x 40 mm
2 pcs

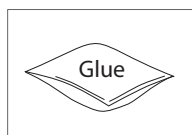

B
optional

step 06

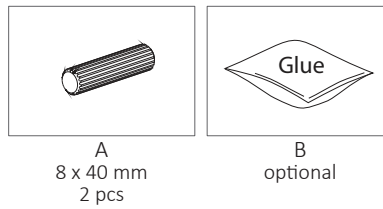
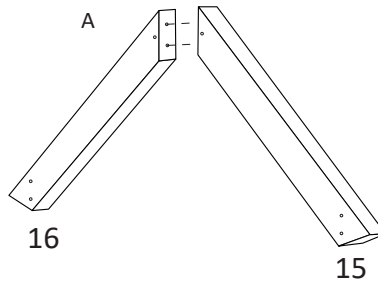

step 07

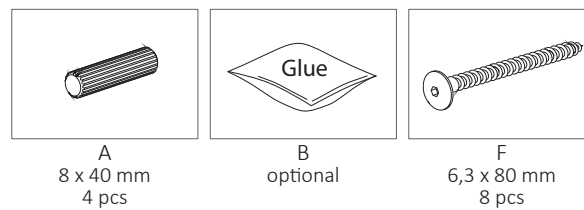
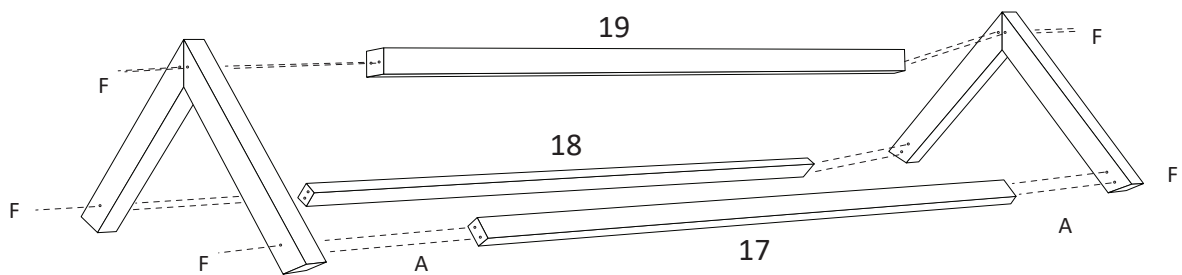

step 08

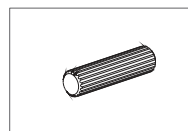
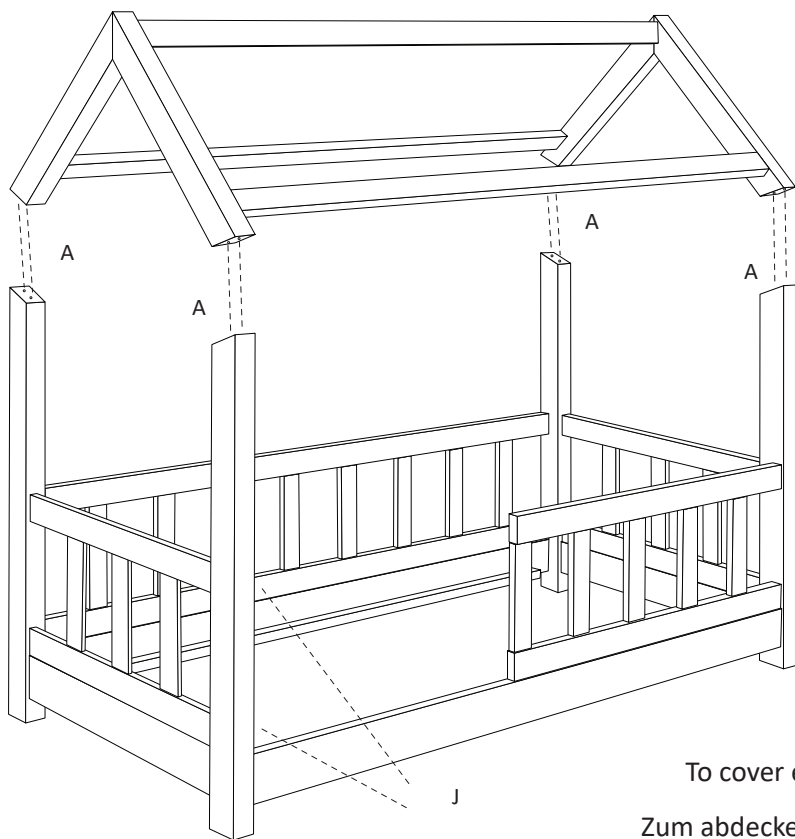

A
8 x 40 mm
8 pcs

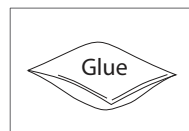

B
optional

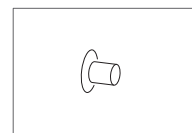

J
M8
3 pcs

To cover excess holes.

Zum abdecken überschüssige
Löcher.

step 09

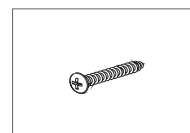
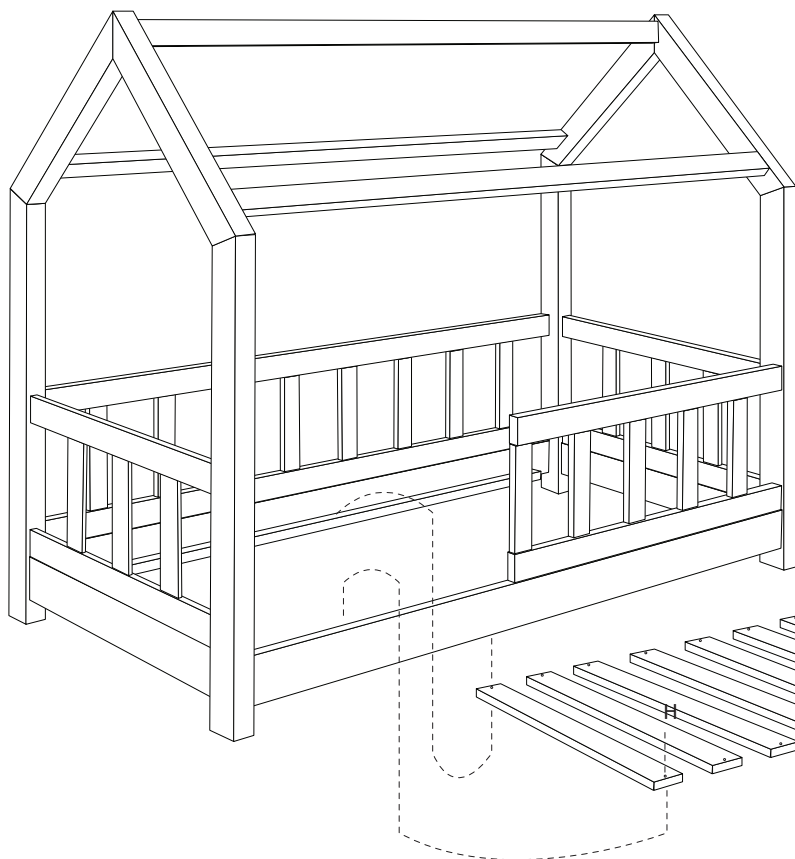

H
3,5 x 40 mm
20 pcs

ready

