

# ANGEL

## ARTV 165

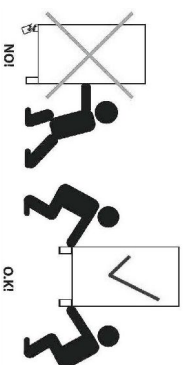
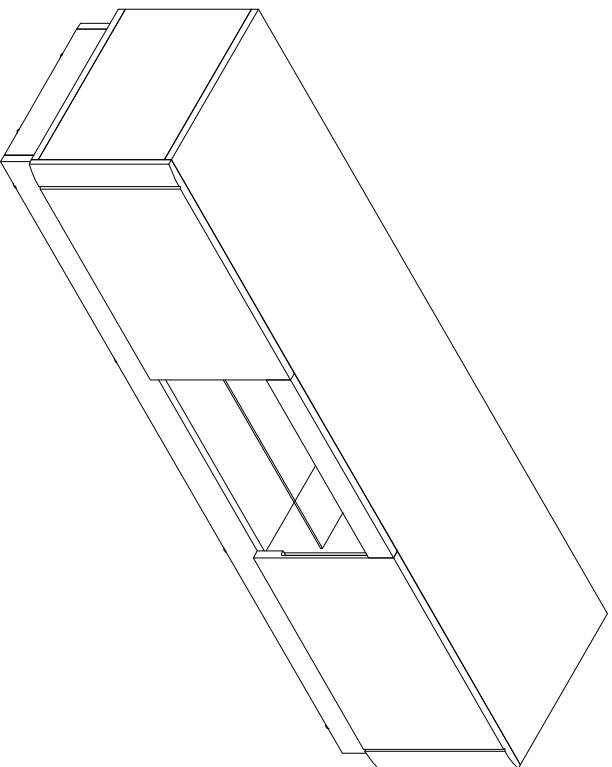

21.3.2018

- (D)** Montageanleitung
- (FR)** Notice de montage
- (NL)** Handleiding voor de montage
- (CZ)** Montážní návod
- (HU)** Szerelési útmutató
- (TR)** Montaj talimatı
- (GB)** Assembly Instructions
- (IT)** Istruzioni di montaggio
- (PL)** Instrukcja montażu
- (SK)** Návod na montáž
- (RO)** Instrucțiunile de montaj
- (RU)** Инструкции по монтажу

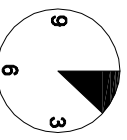
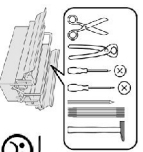

20 min.

1

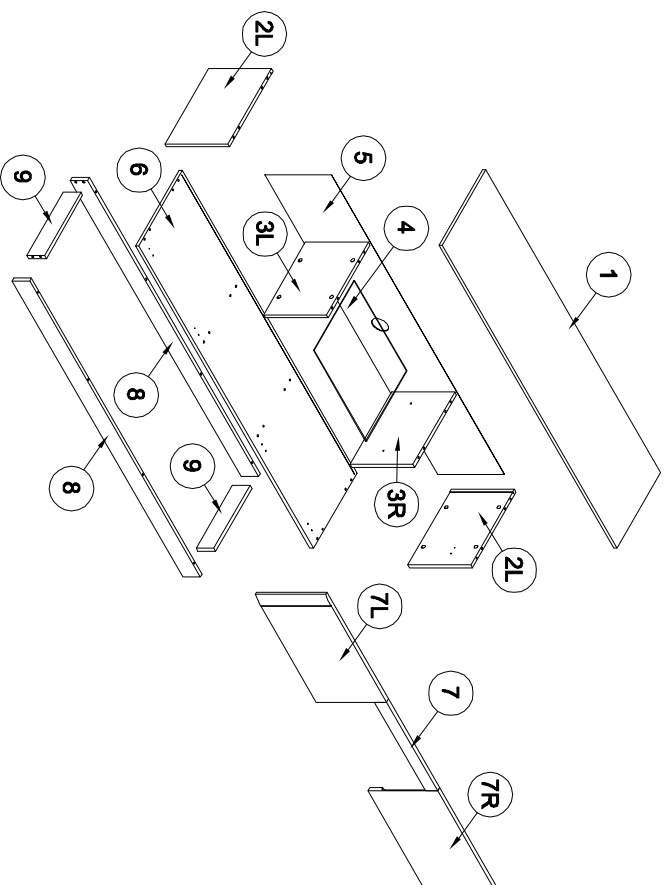

<b>A</b> x16 8x32	<b>Z</b> x16	<b>SLZ</b> x8 3.5x16	<b>N</b> x6 3x20	<b>X</b> x16	<b>ZE</b> x4	<b>NC</b> x4 4x16	<b>GLUE</b> x1
<b>B</b> x16	<b>PC mini</b> x4	<b>O</b> x2	<b>X</b> x16	<b>ZE</b> x4	<b>KNT</b> x2	<b>H</b> x8 6.3x13	<b>RC mini</b> x4
<b>C</b> x16	<b>ND</b> x18	<b>ND</b> x18	<b>O</b> x2	<b>B</b> x16	<b>KNT</b> x2	<b>H</b> x8	<b>RC mini</b> x4

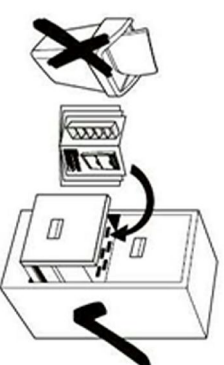
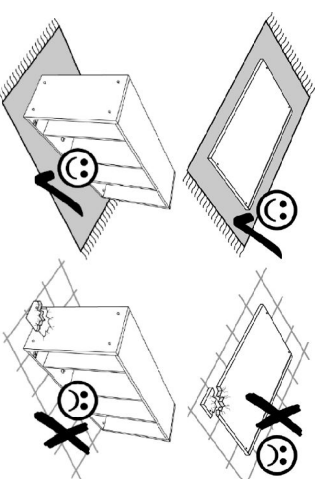

2

3

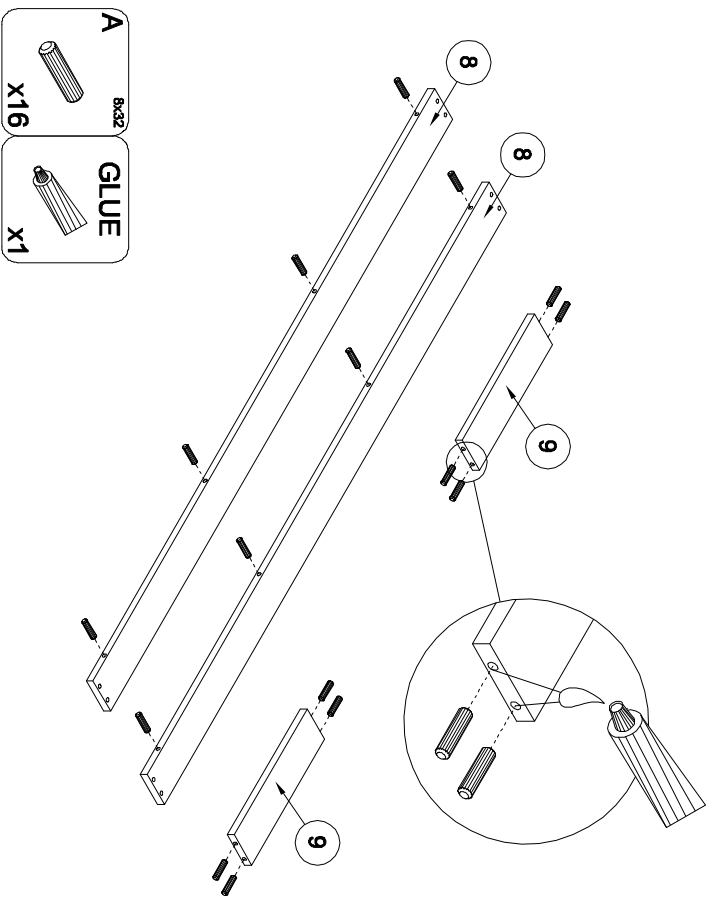

5

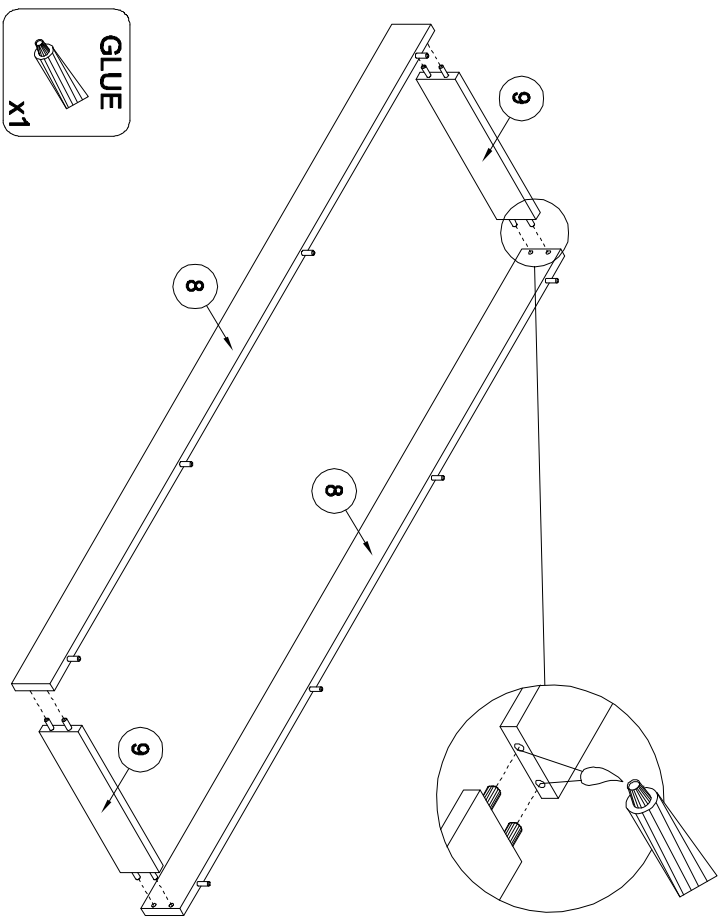

4

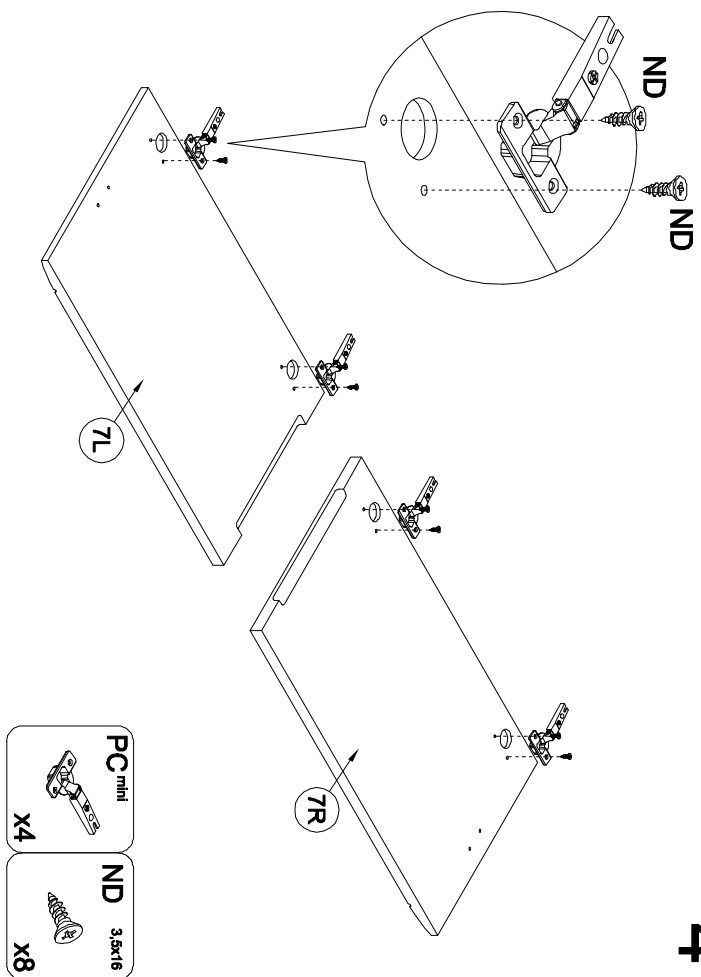

6

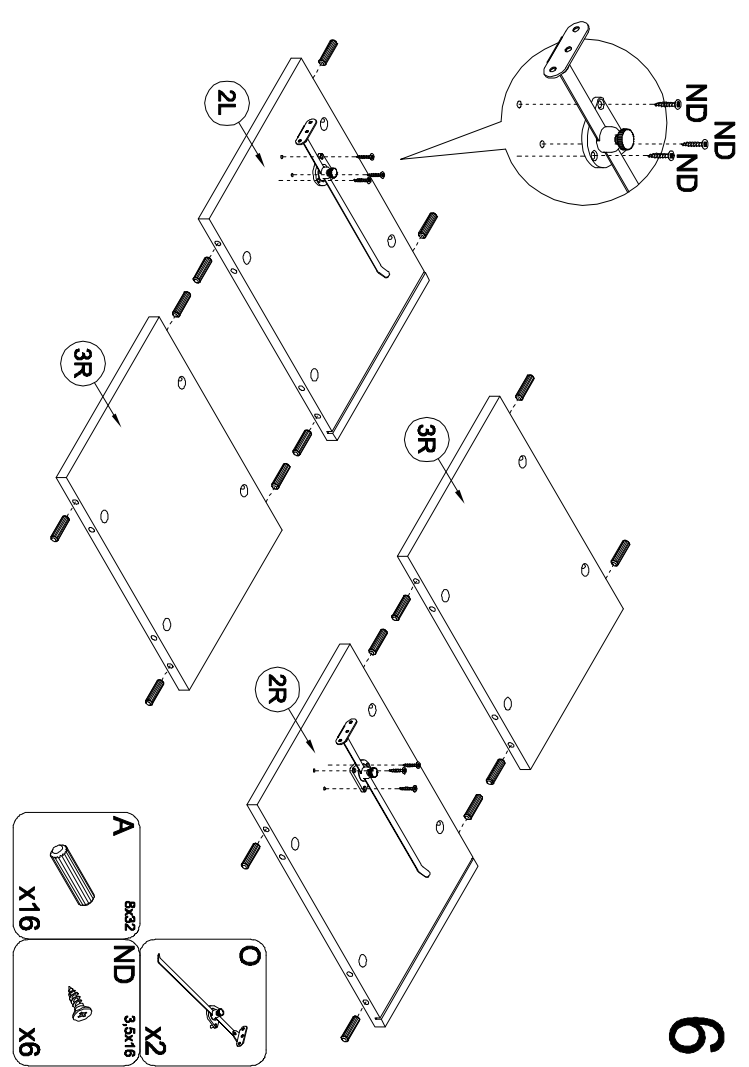

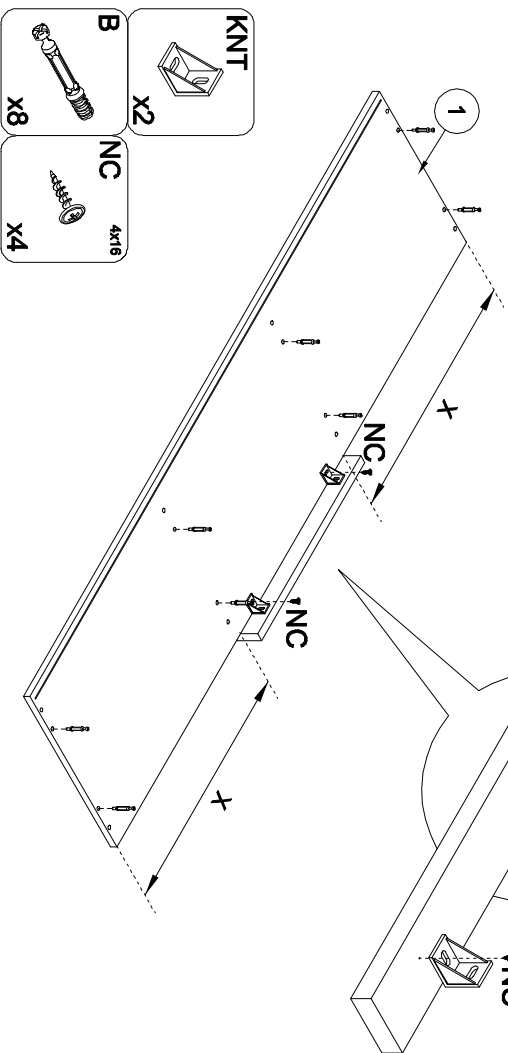
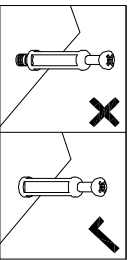

7

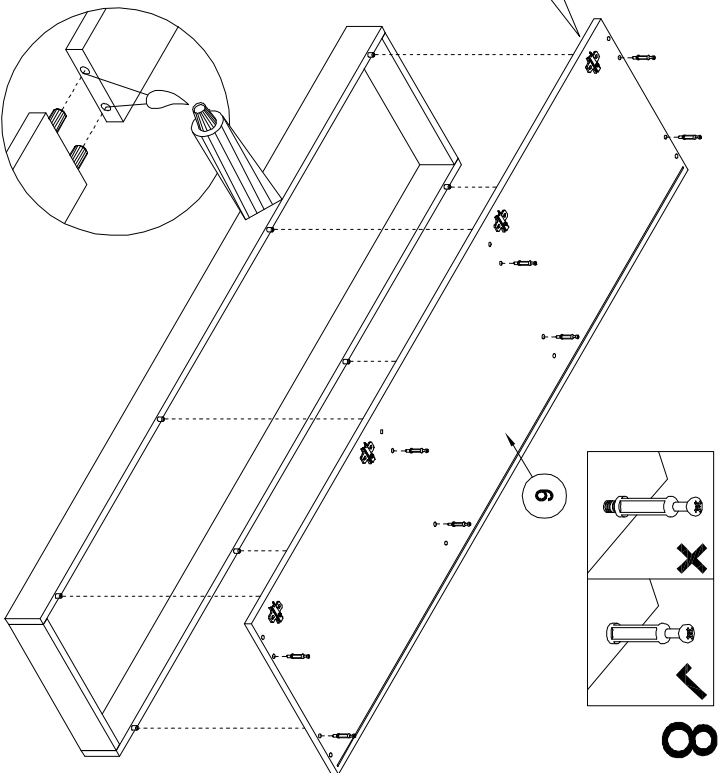
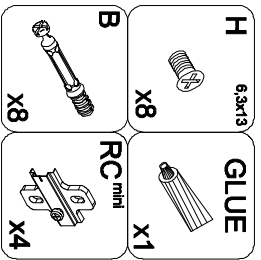

8

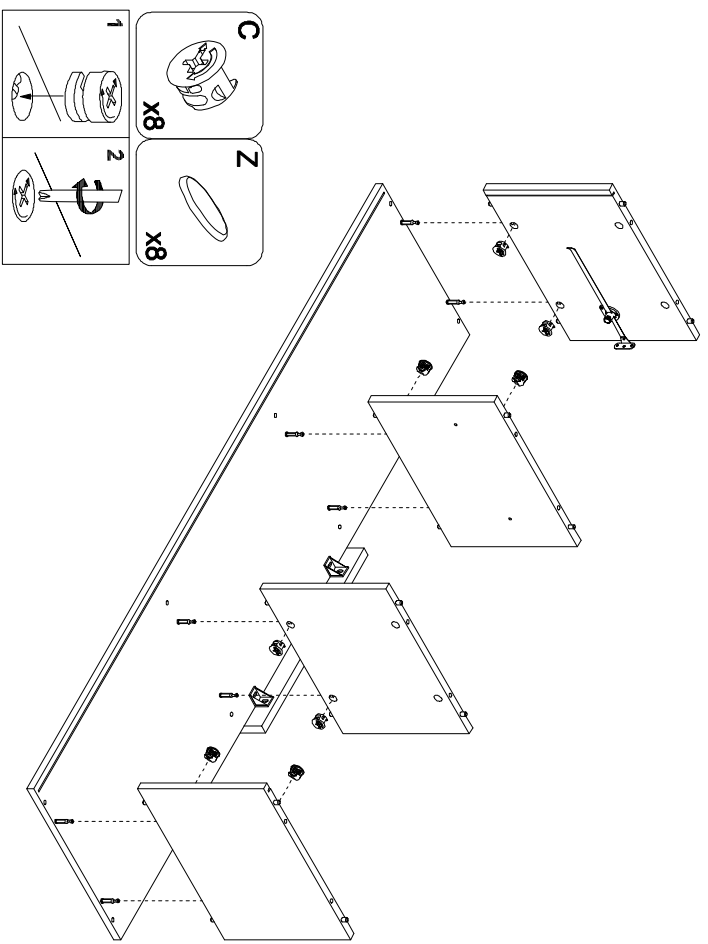

9

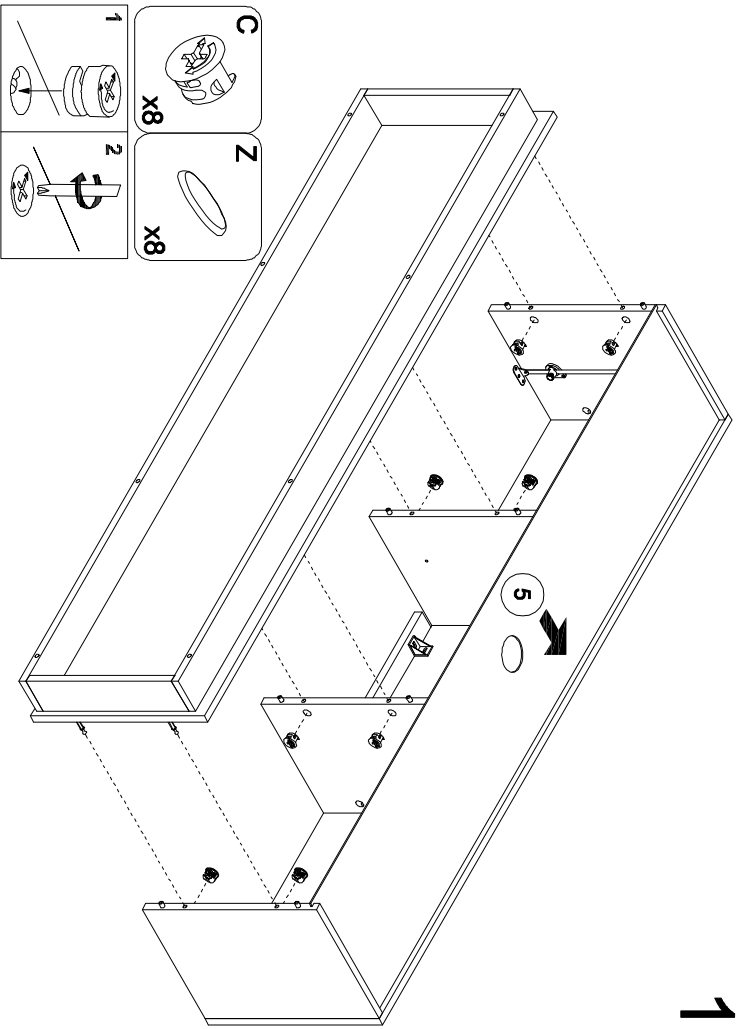

10

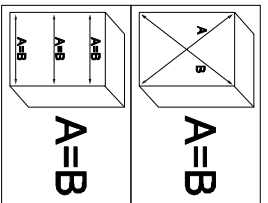

11

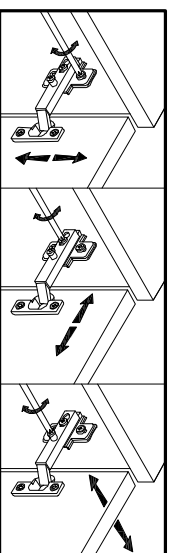
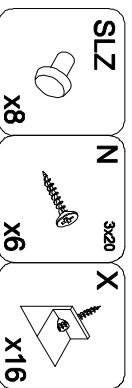
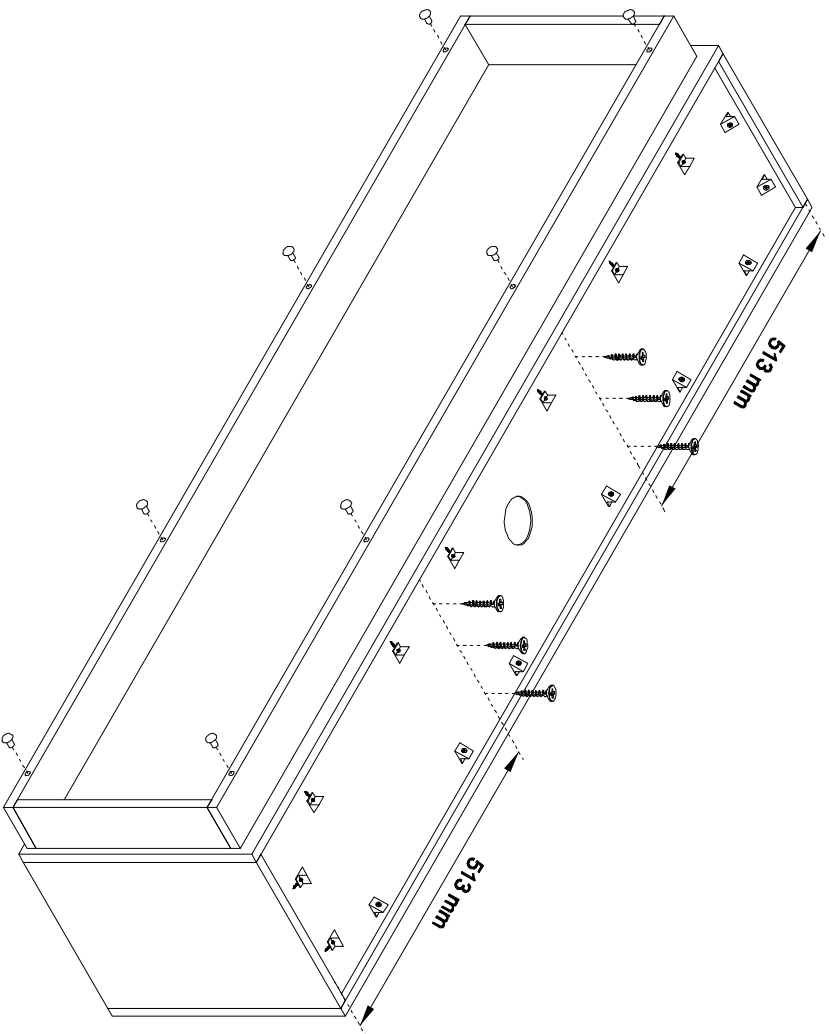

12

