

**79418** A

[www.tvilum.com](http://www.tvilum.com)

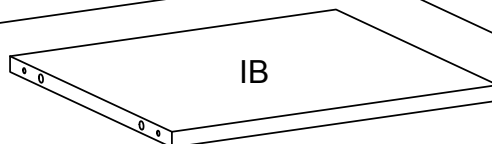

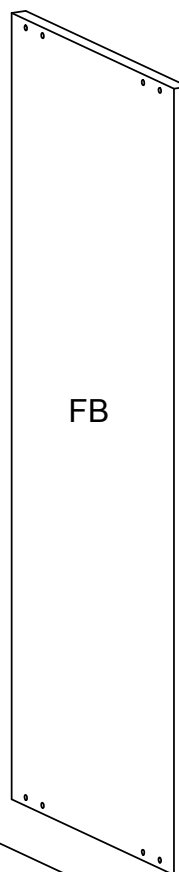
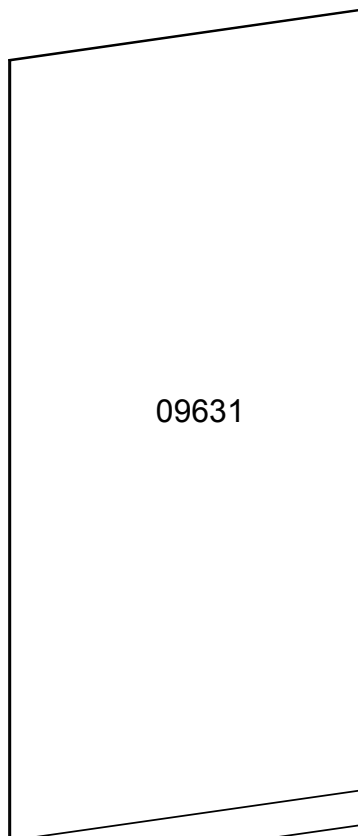
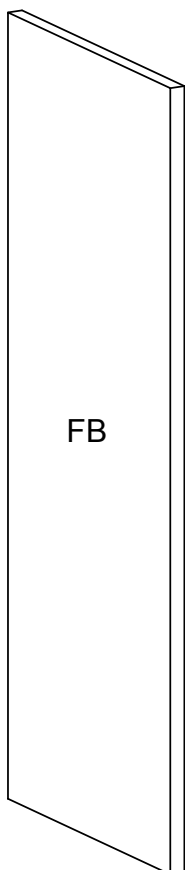
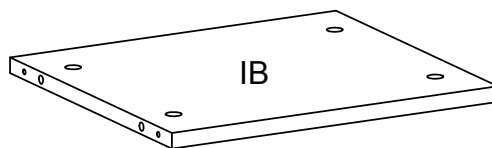
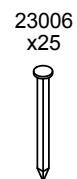
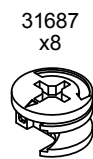
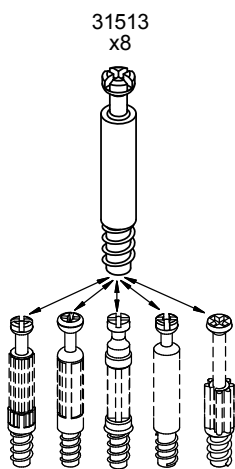
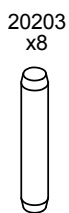
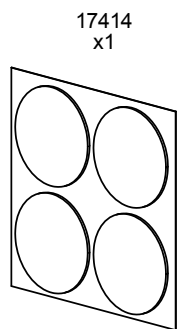
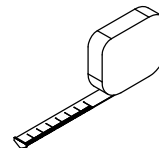
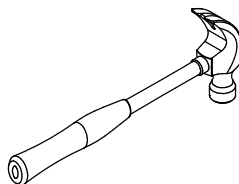
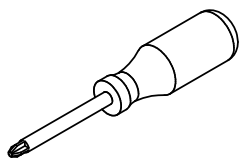
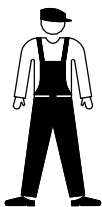

1

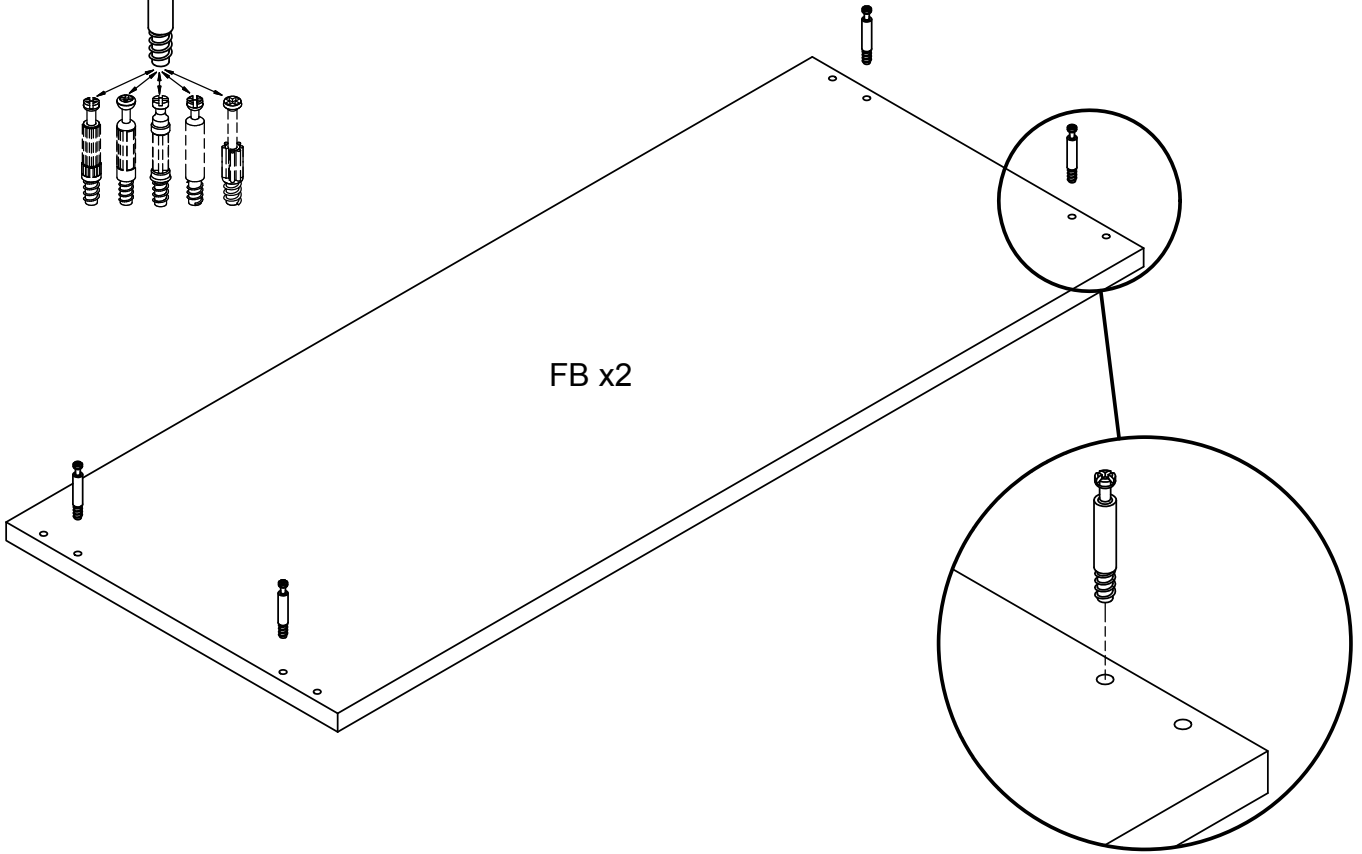
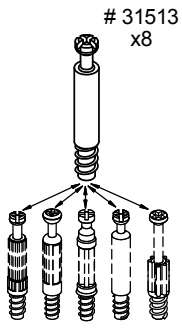

2

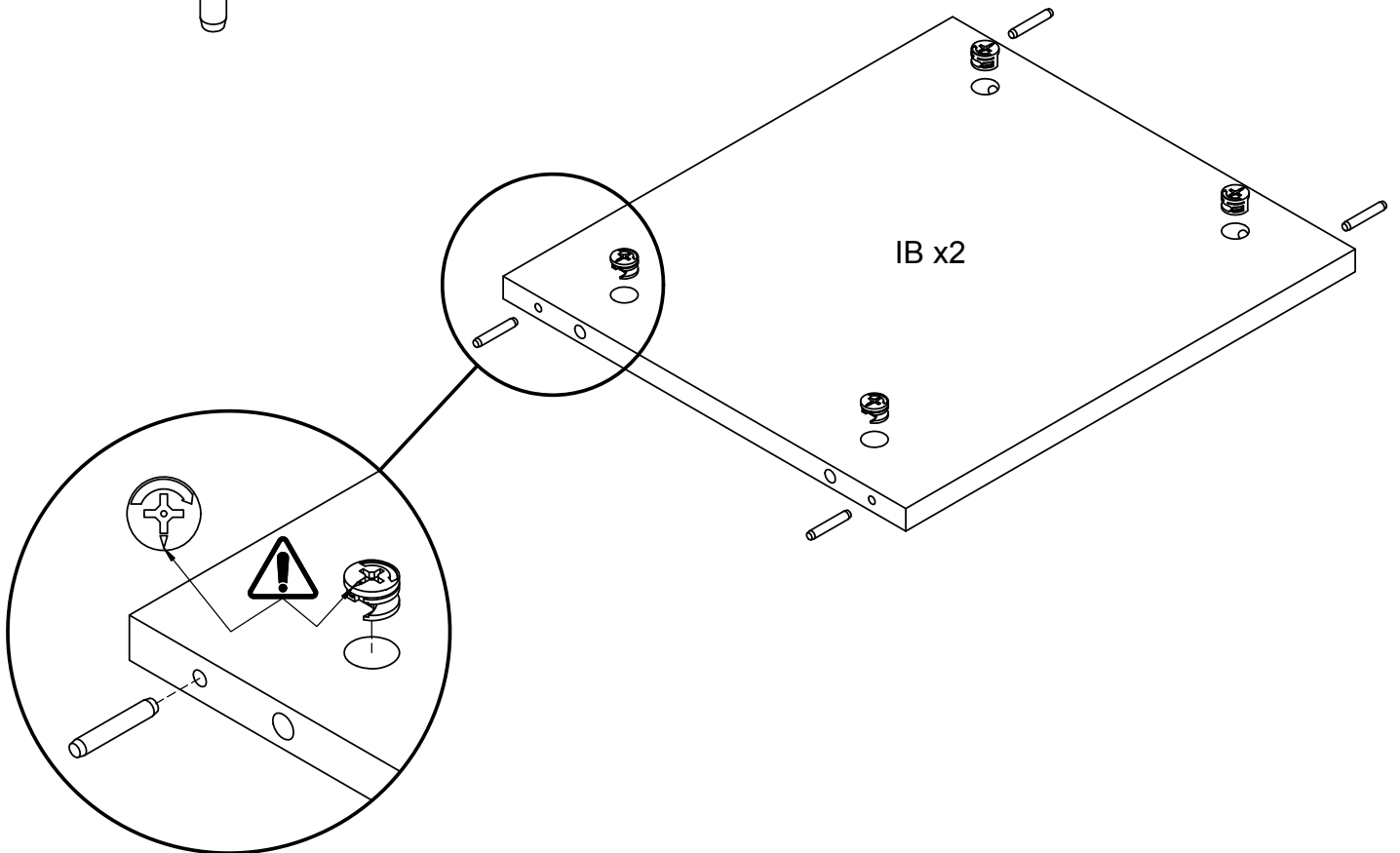
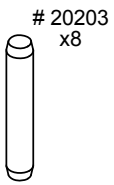

3

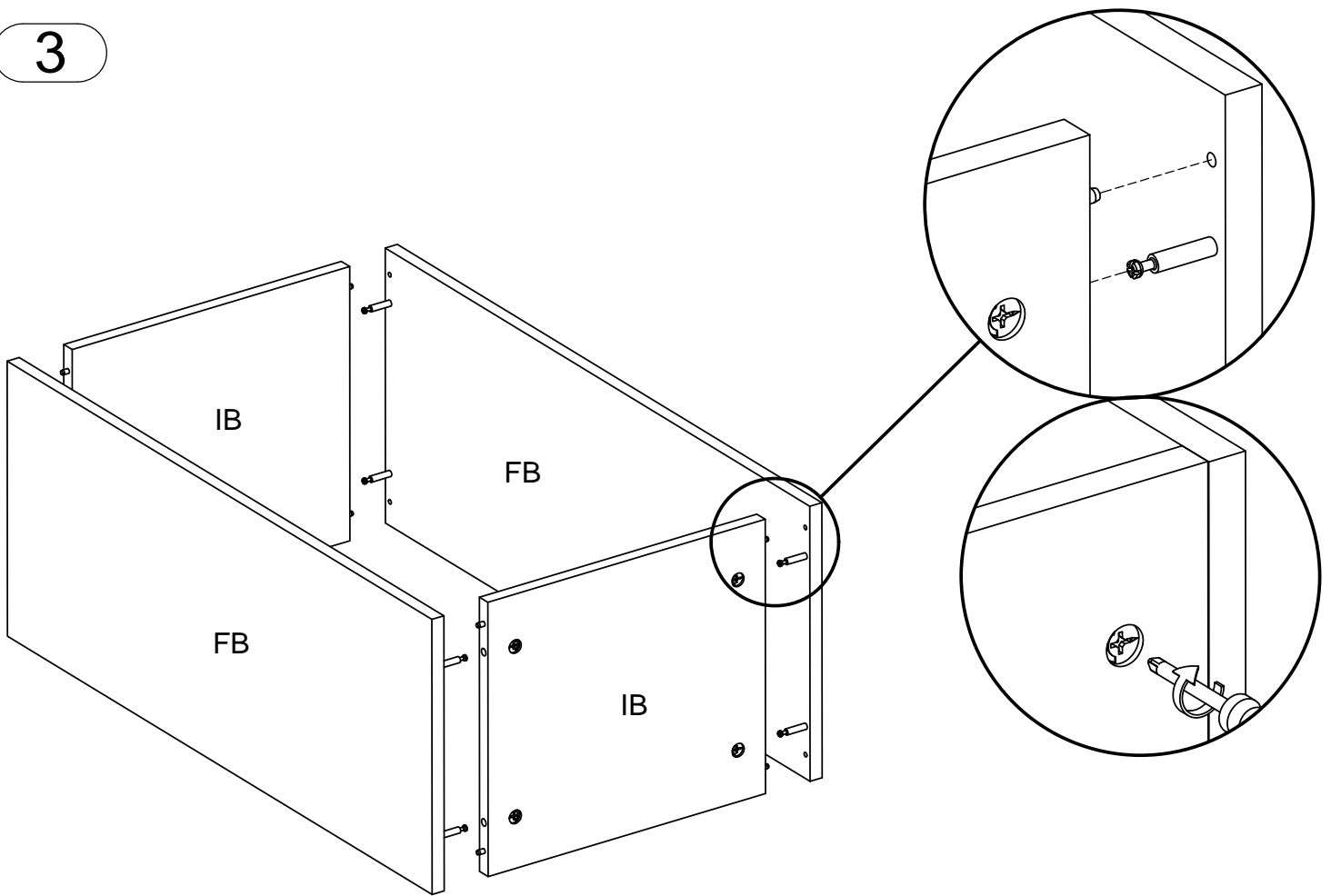

4

# 23006  
x20

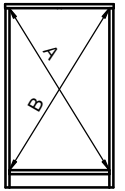
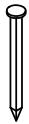

A = B

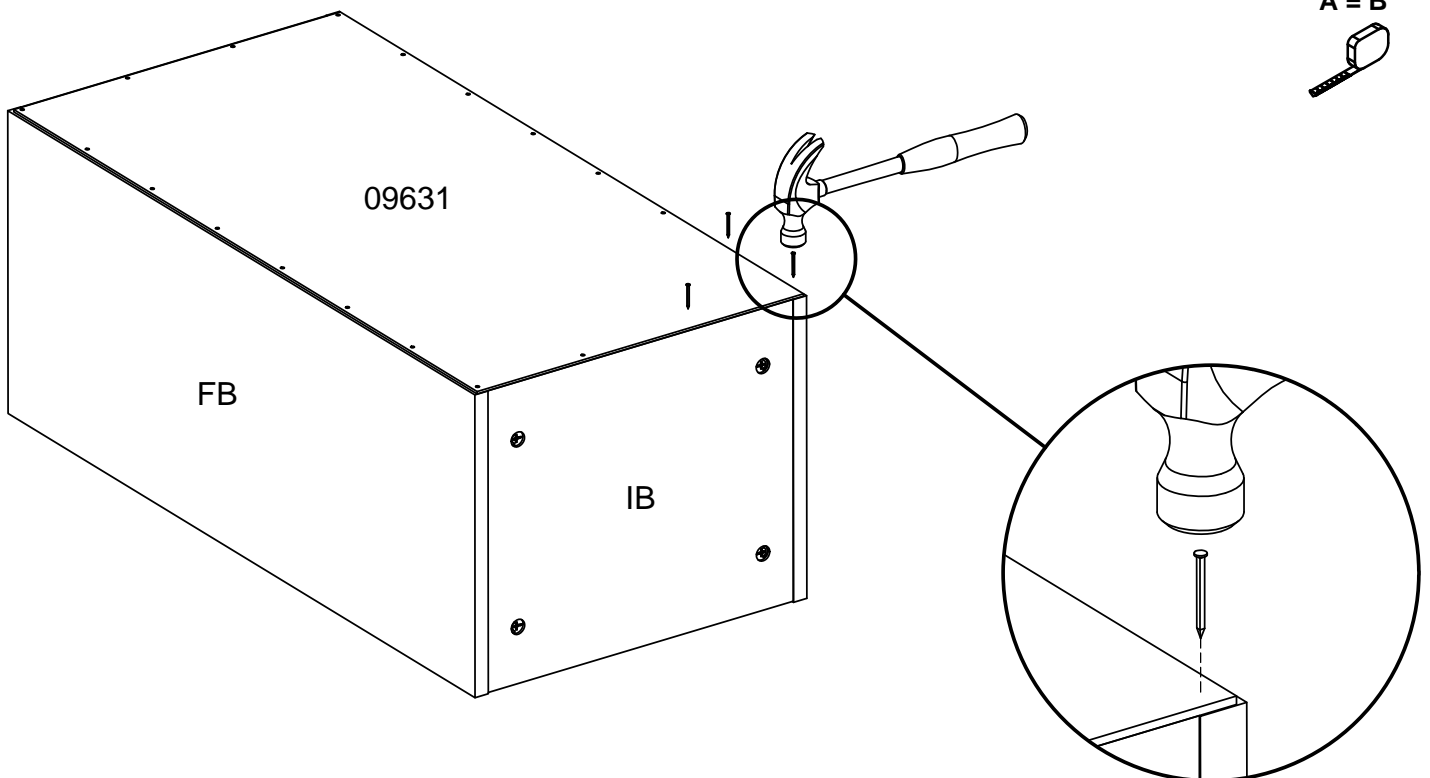

5

# 17414  
x1

