

980441

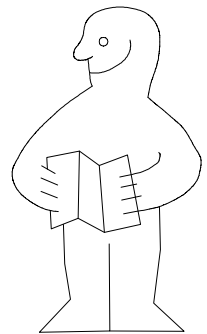

1-2-3-4...

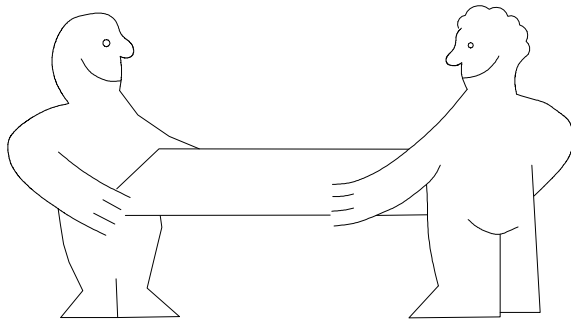
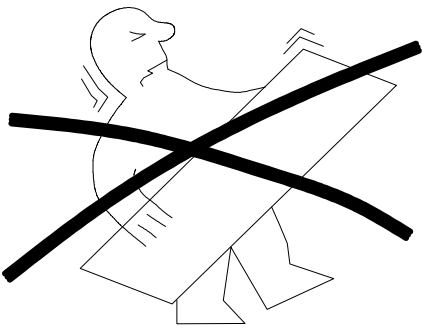
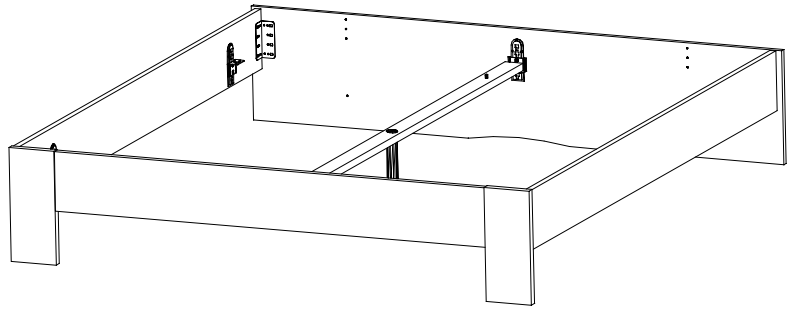
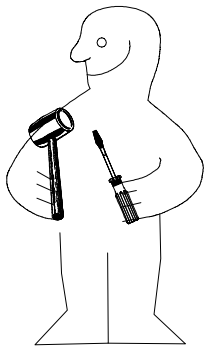
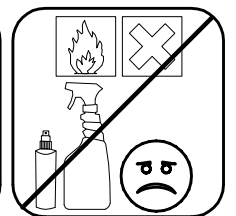
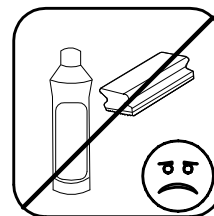
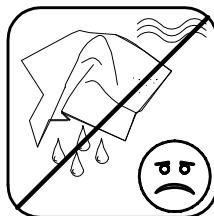
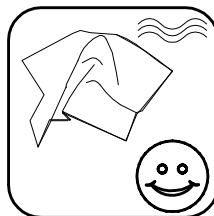
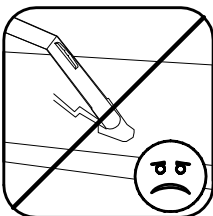
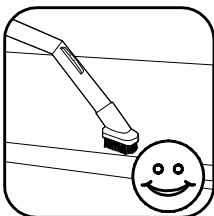
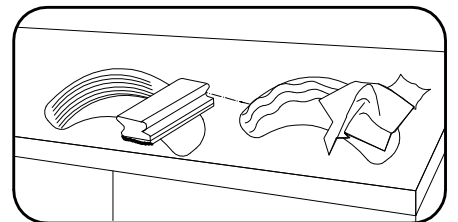
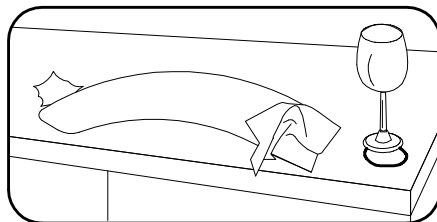
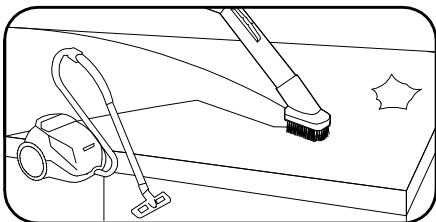
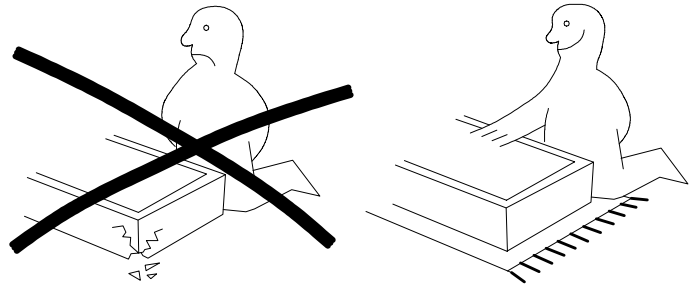
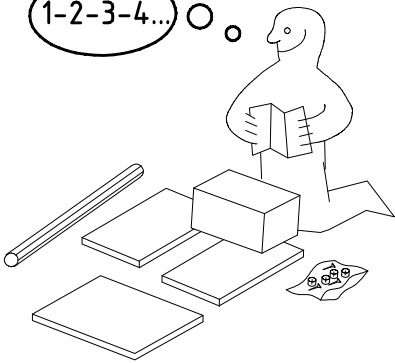

014 111 135	4x
09 111625	1x
07 111 627	6x
06 111 626	6x
H5 114 184S	2x

4,0 x 15 mm G23 121 110	44x
H φ 10 x 13 mm 111 112	6x
6,0 x 12 mm G4 121 148	6x
4 X 20mm SP20 121 121	16x
Z 163 007	2x

US 129 407	4x
G6 121 150	4x
5,0 x 35 mm G51 121 149	4x
D 353 018	2x
D10 φ10 x 60	6x

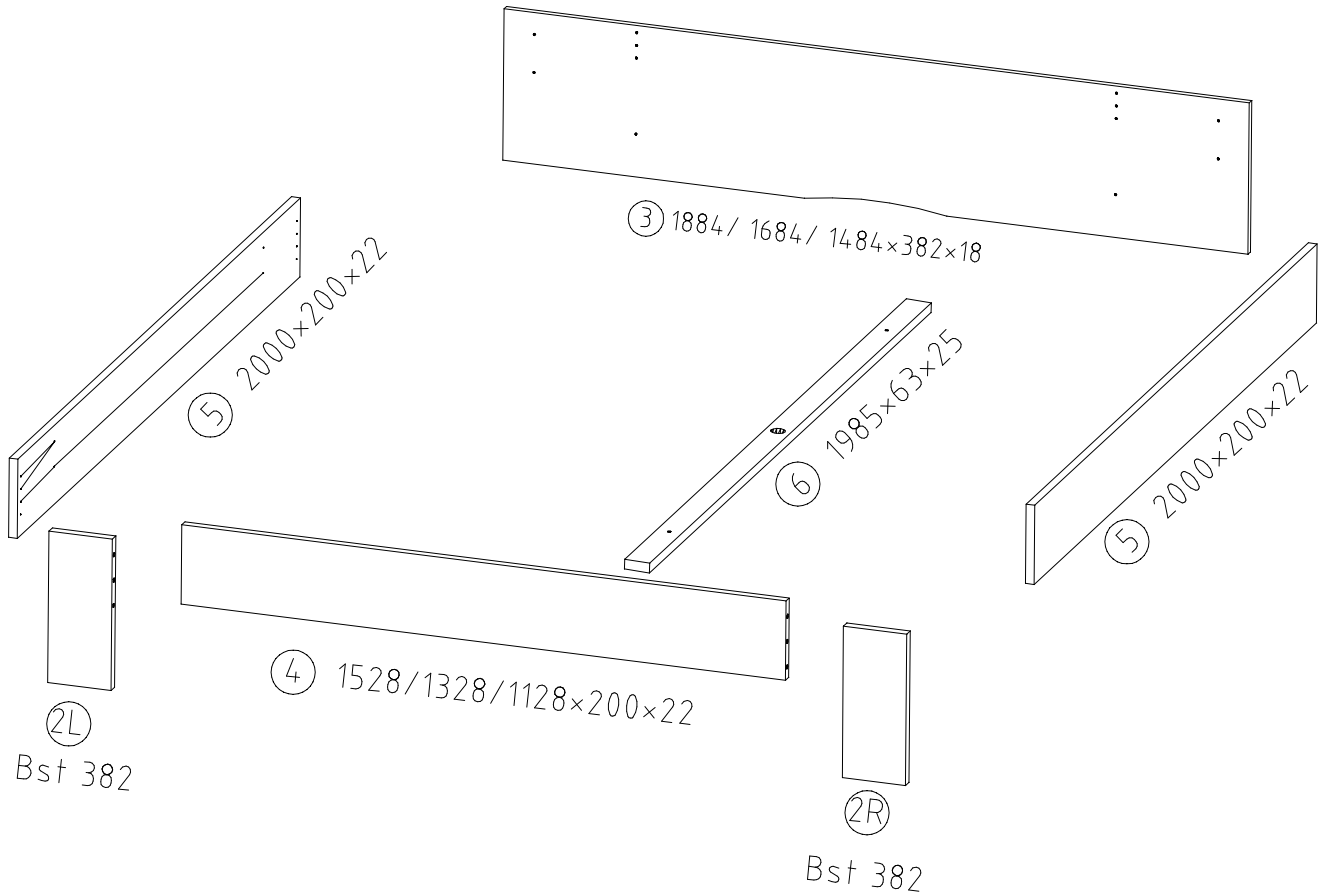
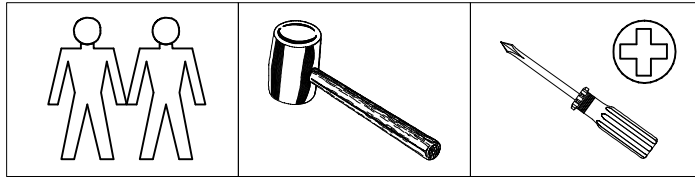
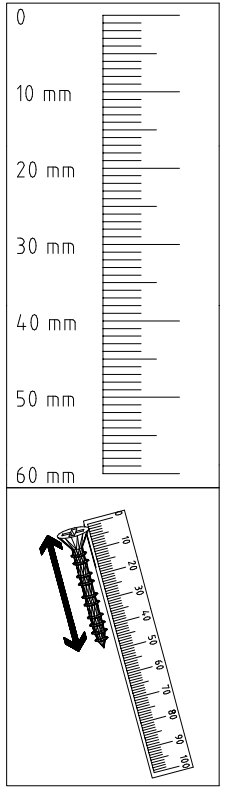
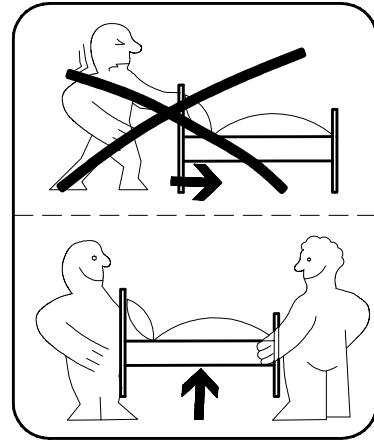

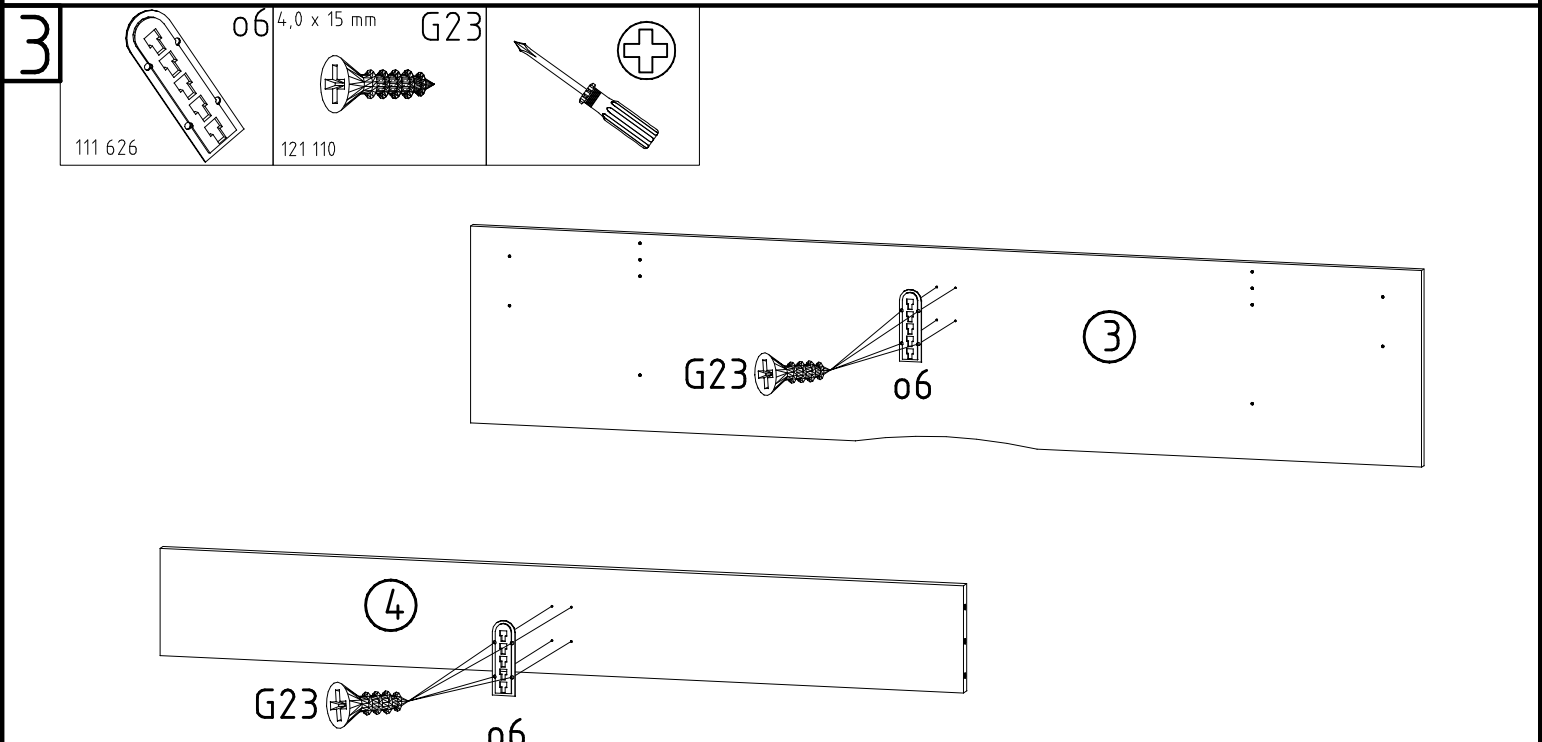
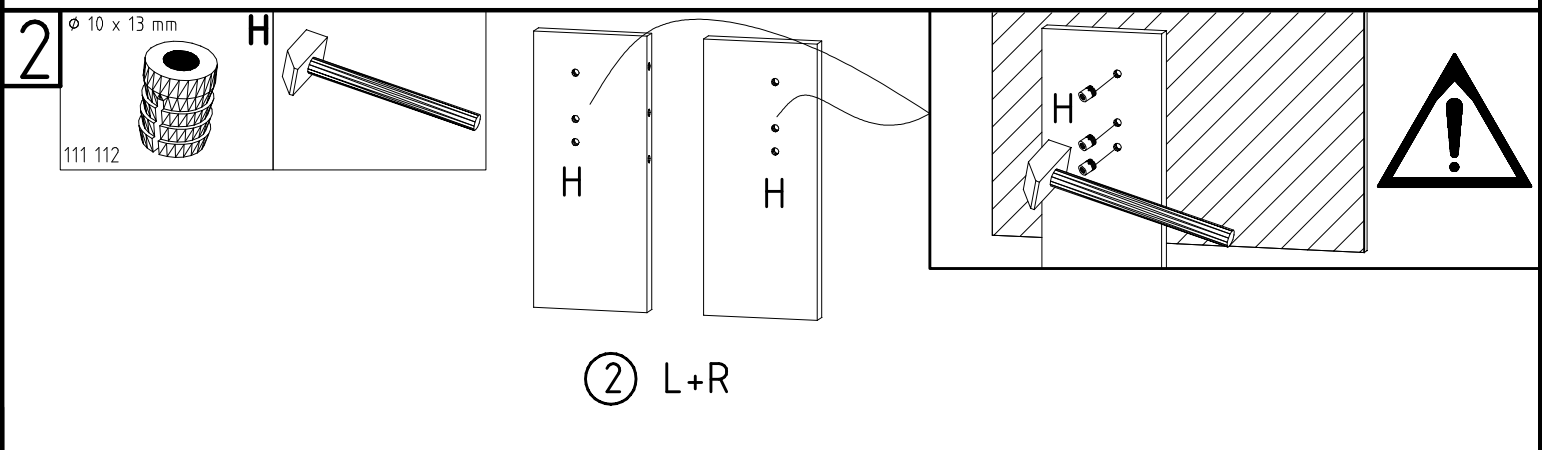
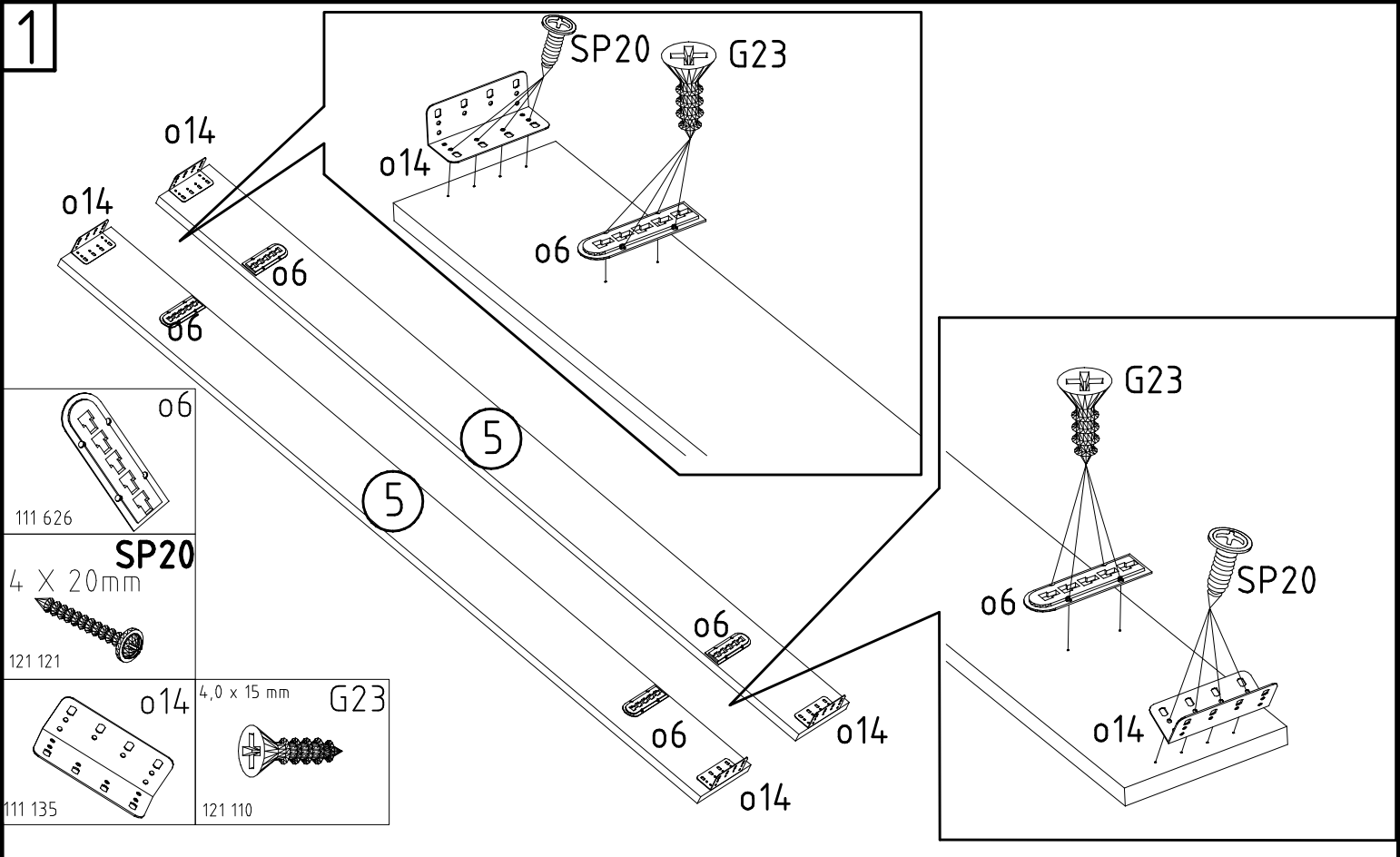

4

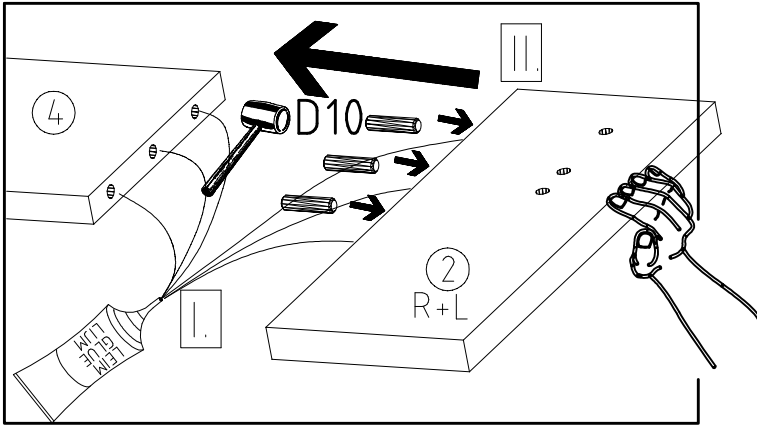

<p>LEIM FLIEM 163 007</p>	<p>D10 φ10 x 60</p>
<p>114 183</p>	<p>H5 4,0 x 15 mm</p>
<p>+</p>	<p>G23 121 110</p>

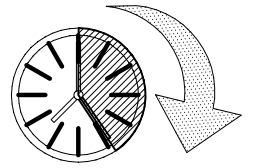
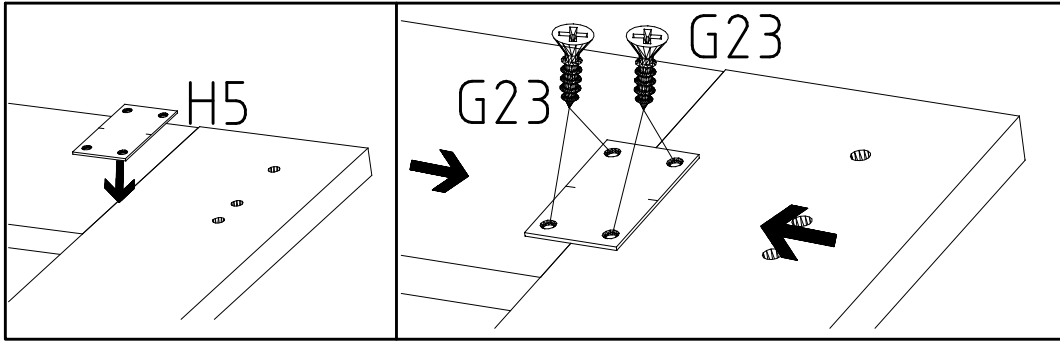

5

<p>4,0 x 15 mm G23 121 110</p>
<p>07 111 627</p>
<p>09 111 625</p>
<p>D 353 018 φ8 x 30</p>

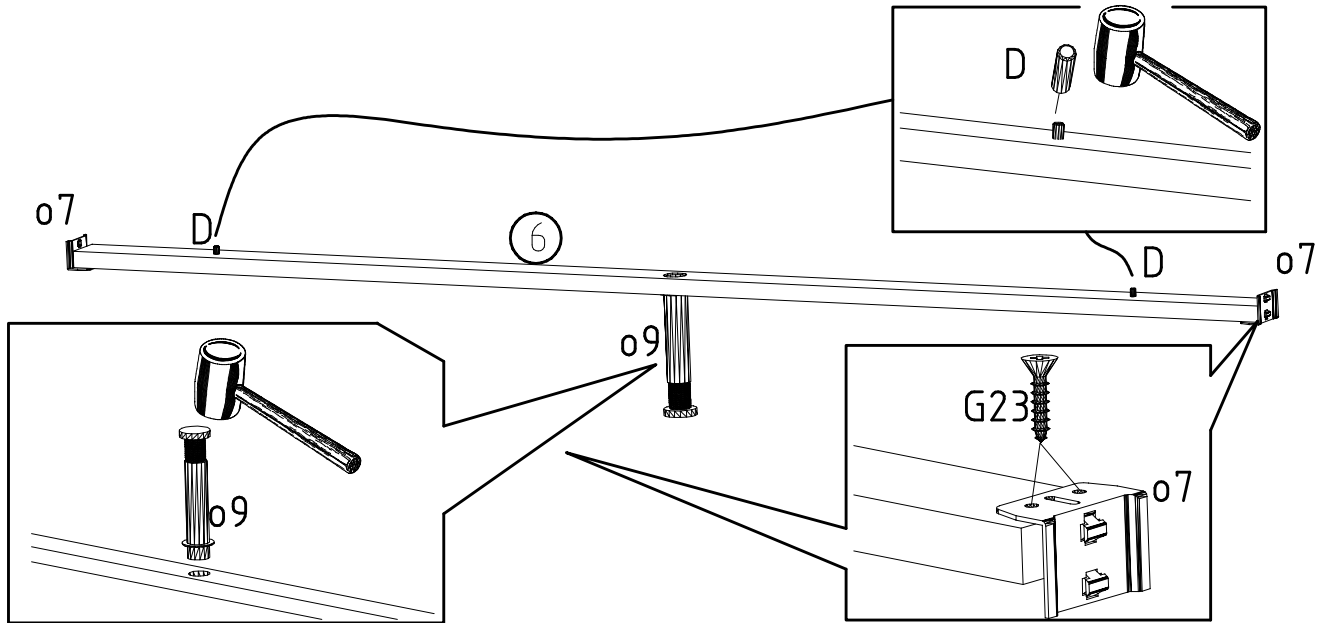

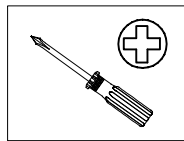
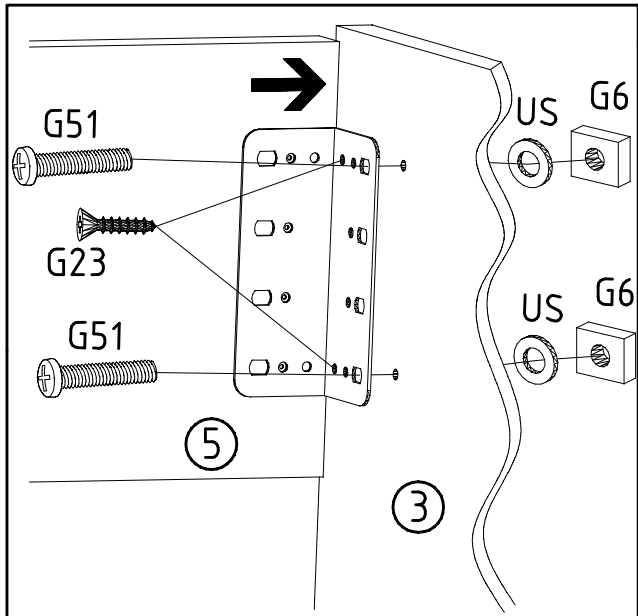
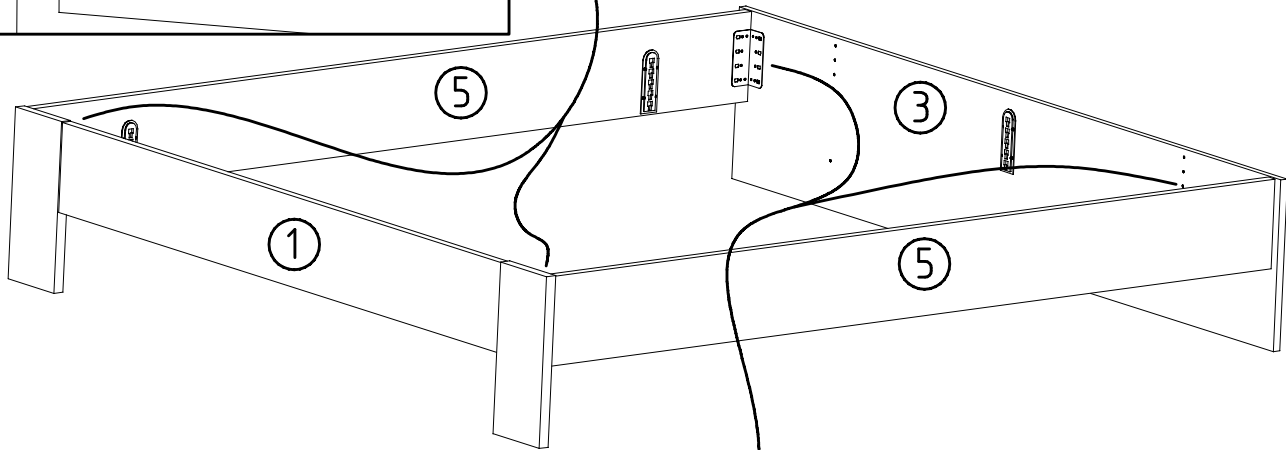
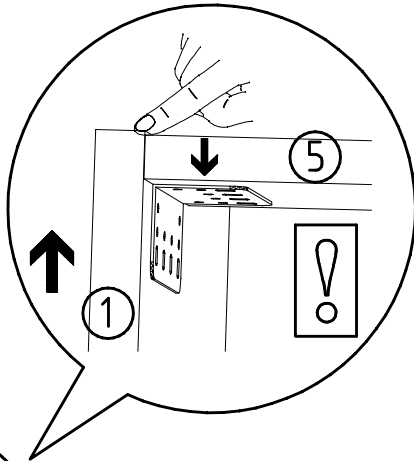
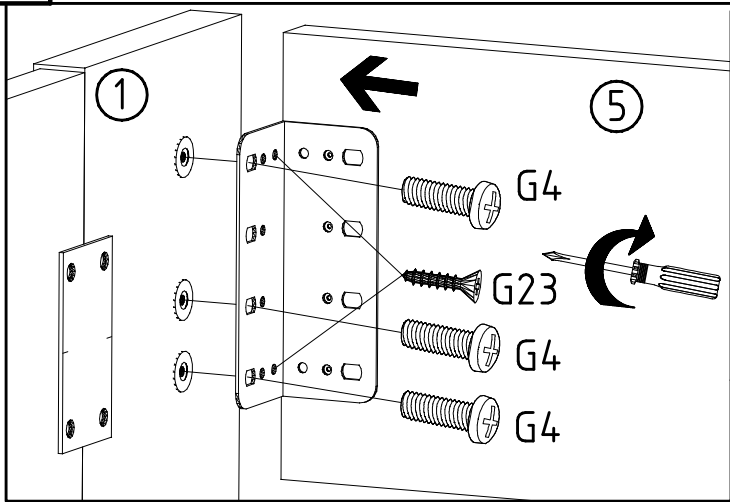

6,0 x 12 mm	G4	
121 148		
5,0 x 35 mm	G51	
121 149		
	G6	
		121 150
	US	
129 4-07	φ12	
	G23	
		121 110

