

TIMO

OP 5

PRZED ROZPOCZĘCIEM MONTAŻU ZAPOZNAĆ SIĘ Z INSTRUKCJĄ

Narzędzia niezbędne do montażu (nie dostarczane przez producenta)

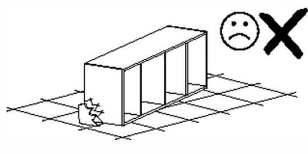
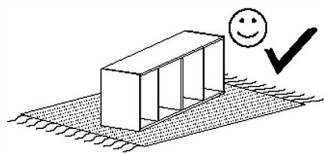

MONTOWAĆ NA MIEKKIM PODŁOŻU TYPU: KOC, DYWAN.

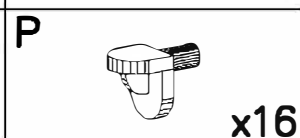
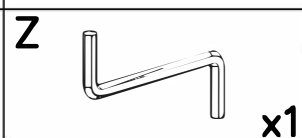
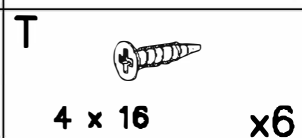
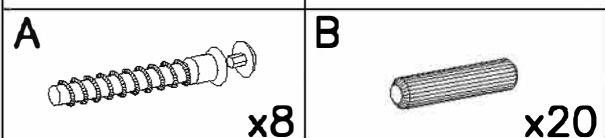
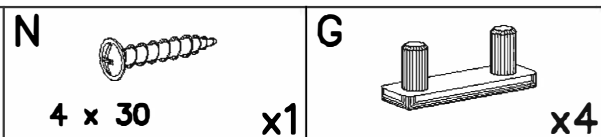
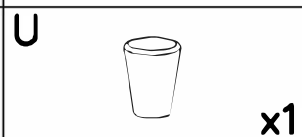
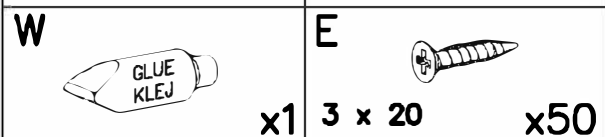
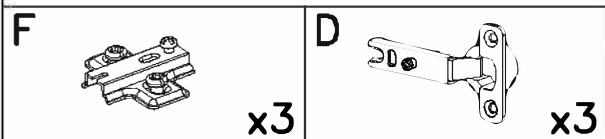
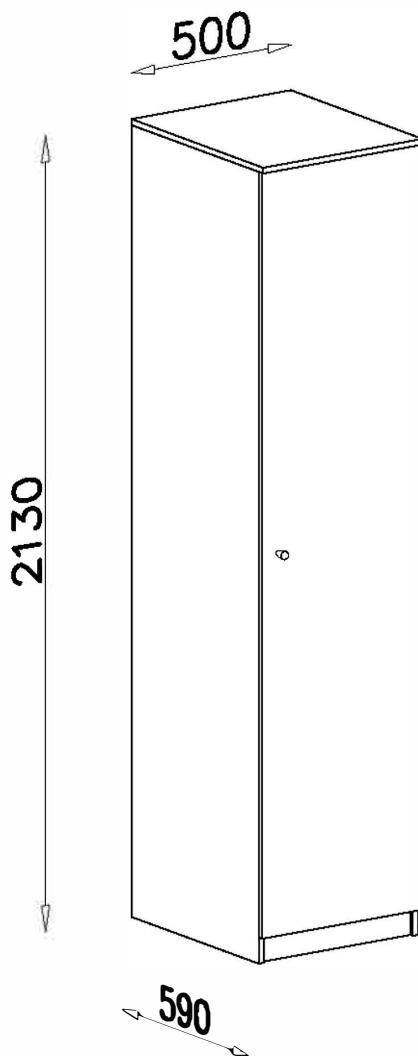
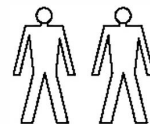
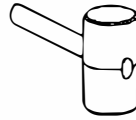
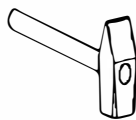

I

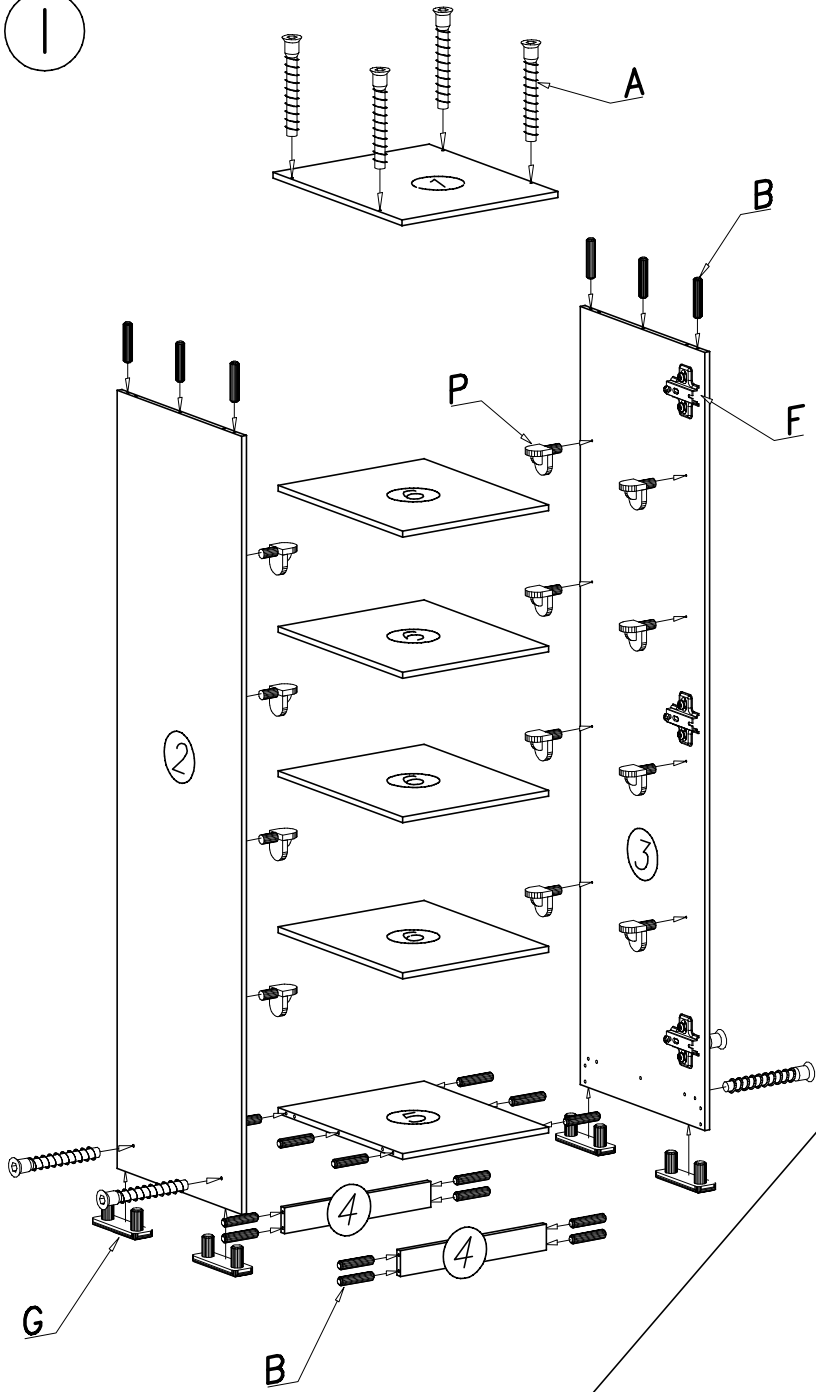

II

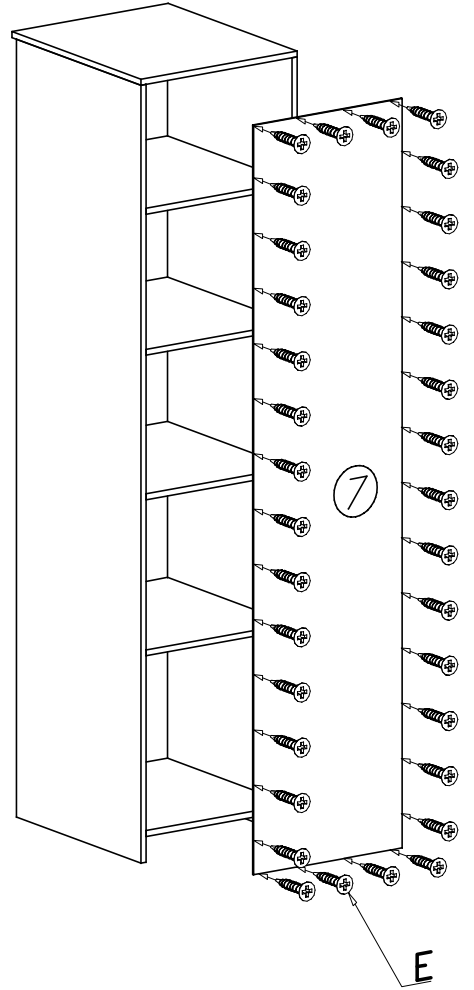

III

