

A	B	C (mm)			D
1	S365-0018	1710	406	15	3/3
2	S365-1024	1944	540	15	2/3
3	S365-1025	1944	540	15	2/3
4	S365-2006	978	540	15	1/3
5	S365-3015	947	520	15	1/3
6	S365-3016	947	520	15	1/3
7	S365-4007	944	40	15	1/3
8	S365-5033	978	80	22	2/3
9	S365-5034	818	80	19	2/3
10	S365-9307	1800	955	2,5	2/3
11	S392-5017	1870	80	22	2/3
12	S392-5018	1870	80	22	2/3
13	dr-943	943	30	15	1/3

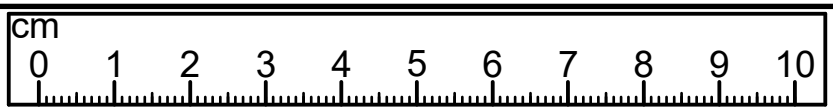

8x a132	2x a133	8x b43	2x c329\2	14x d37	16x e2 Ø6,3x13 mm	12x f1 Ø8x30 mm	1x f35 Ø10x50 mm	4x k1	2x k123	20x l1	14x l2	1x n142 86x21x151,5
2x n158	2x p1 Ø3,5x13 mm	4x p8 Ø4x25 mm	3x p9 Ø4x30 mm	4x p14 Ø3x20 mm	1x p17 Ø5x60 mm	58x p38 Ø3,5x16 mm	16x p51 Ø3,5x15 mm	18x r1 Ø15x12 mm #16	18x r42 20/11	12x s2 Ø16		

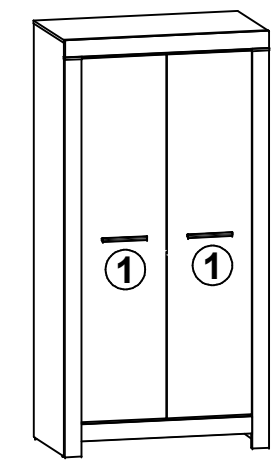
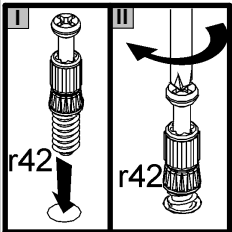
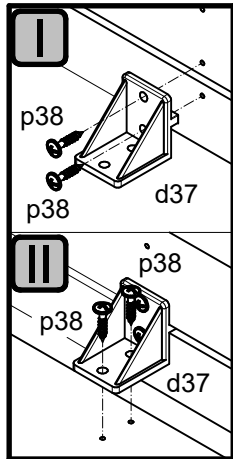
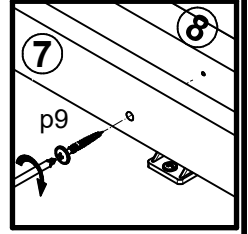
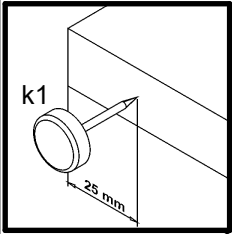
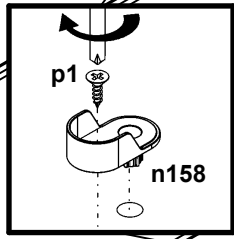
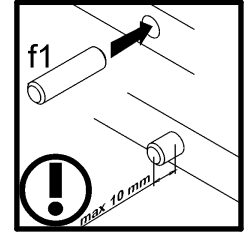
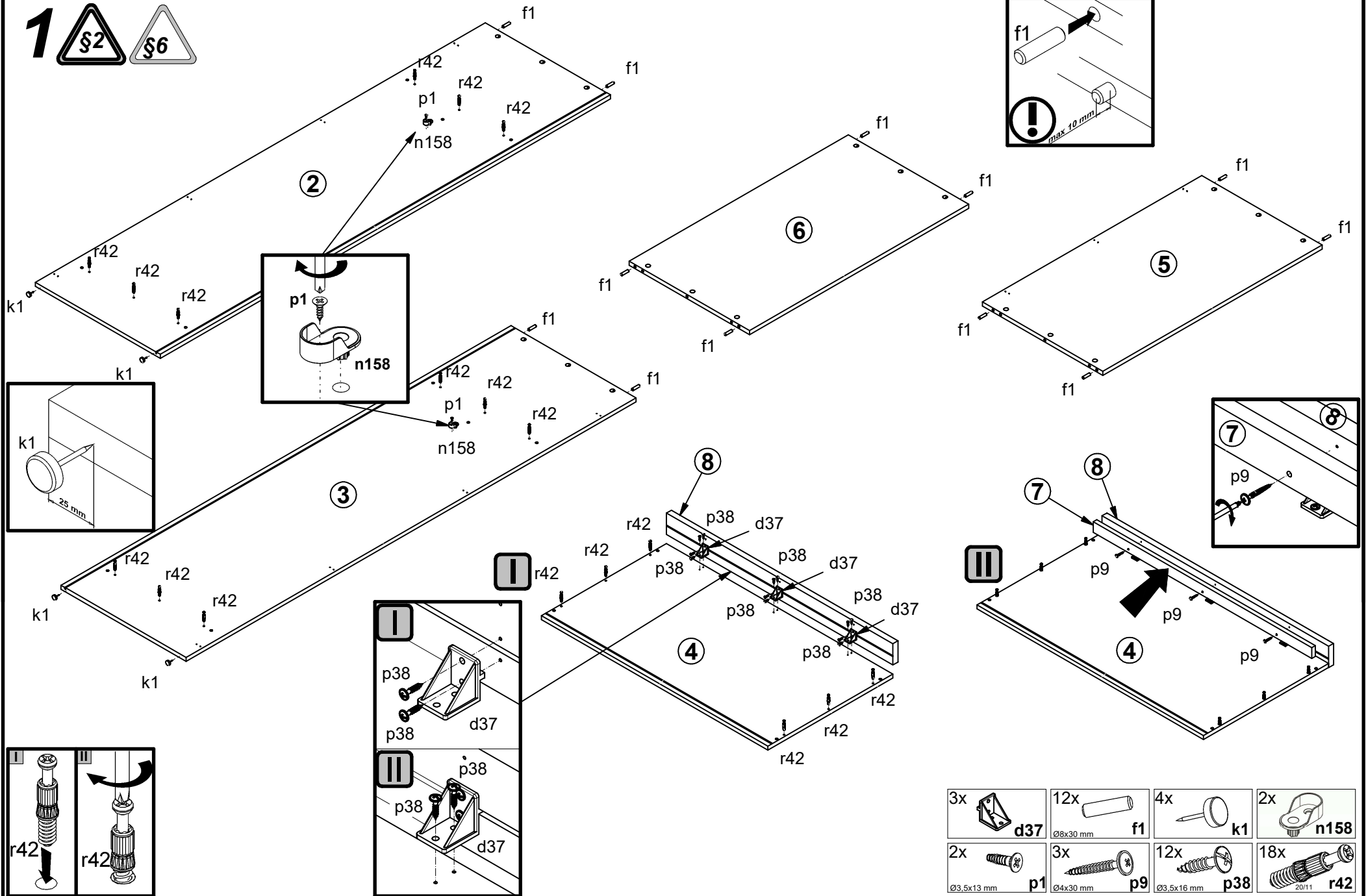

3x d37	12x Ø8x30 mm f1	4x k1	2x n158
2x Ø3,5x13 mm p1	3x Ø4x30 mm p9	12x Ø3,5x16 mm p38	18x 20/11 r42

2 

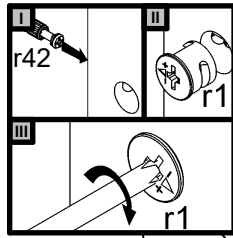

II

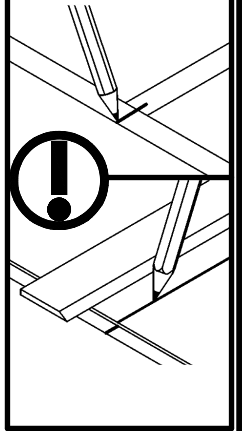

I

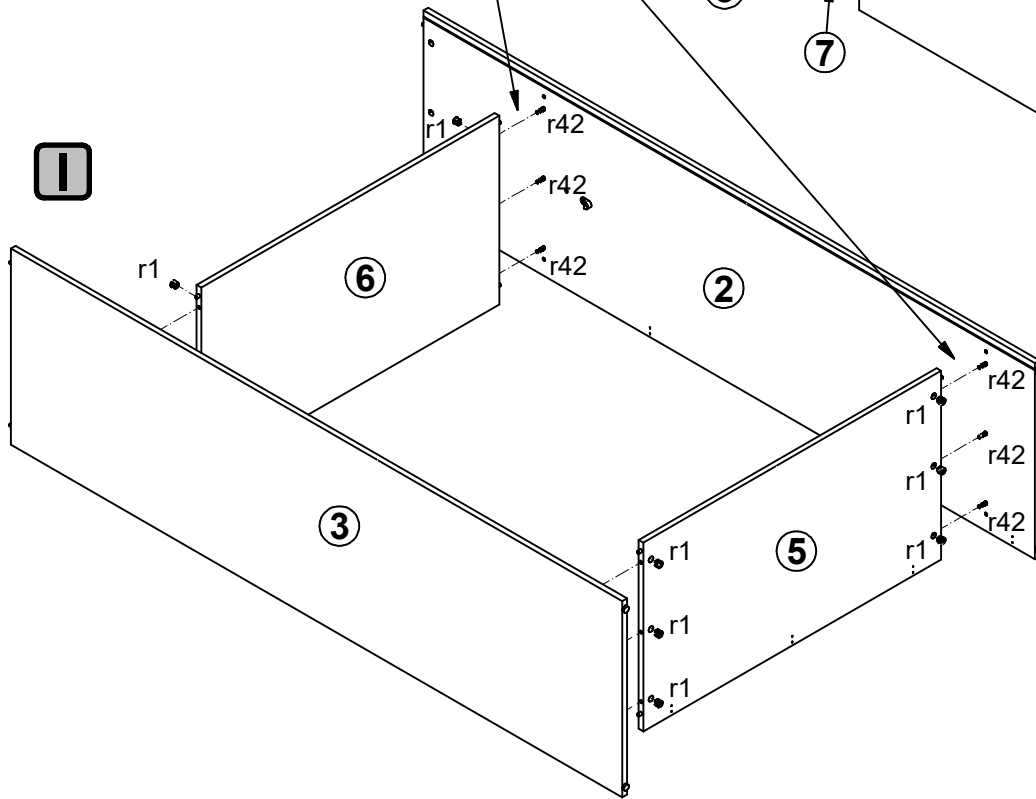

18x  r1
Ø15x12 mm #16

3

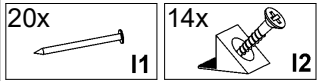
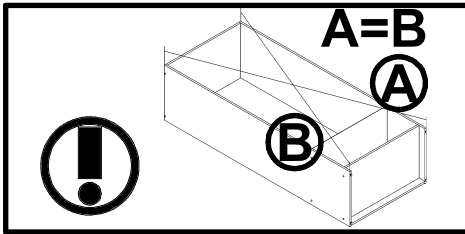
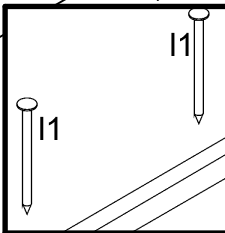
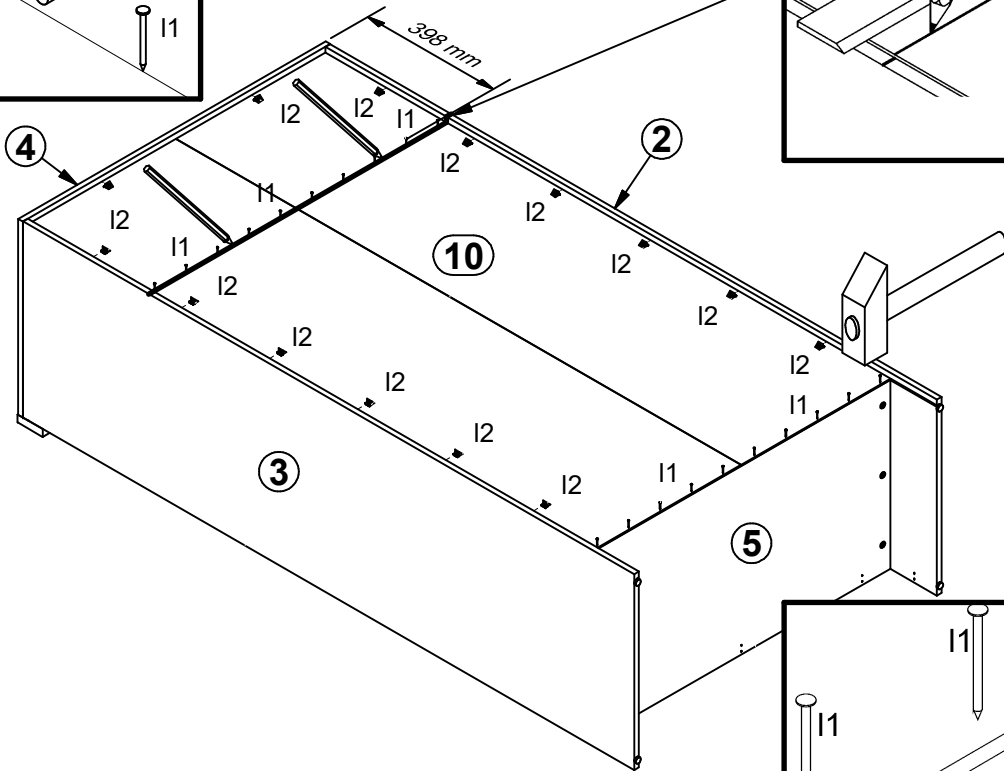
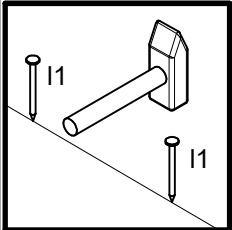
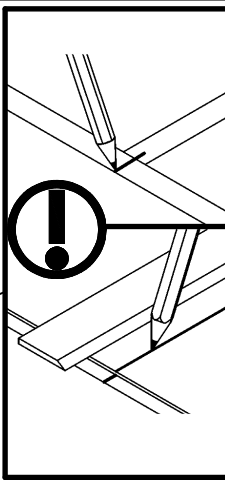
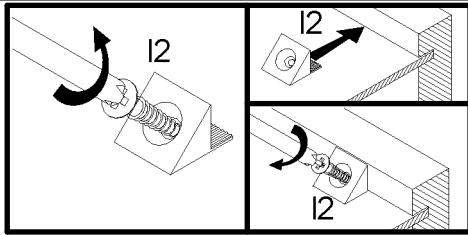

4

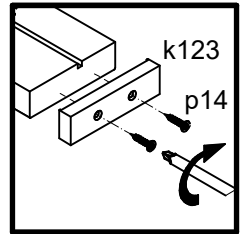
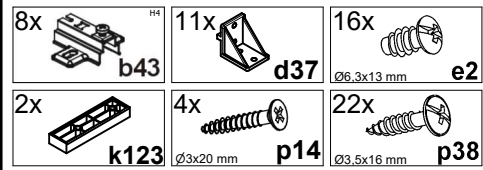
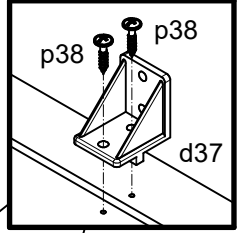
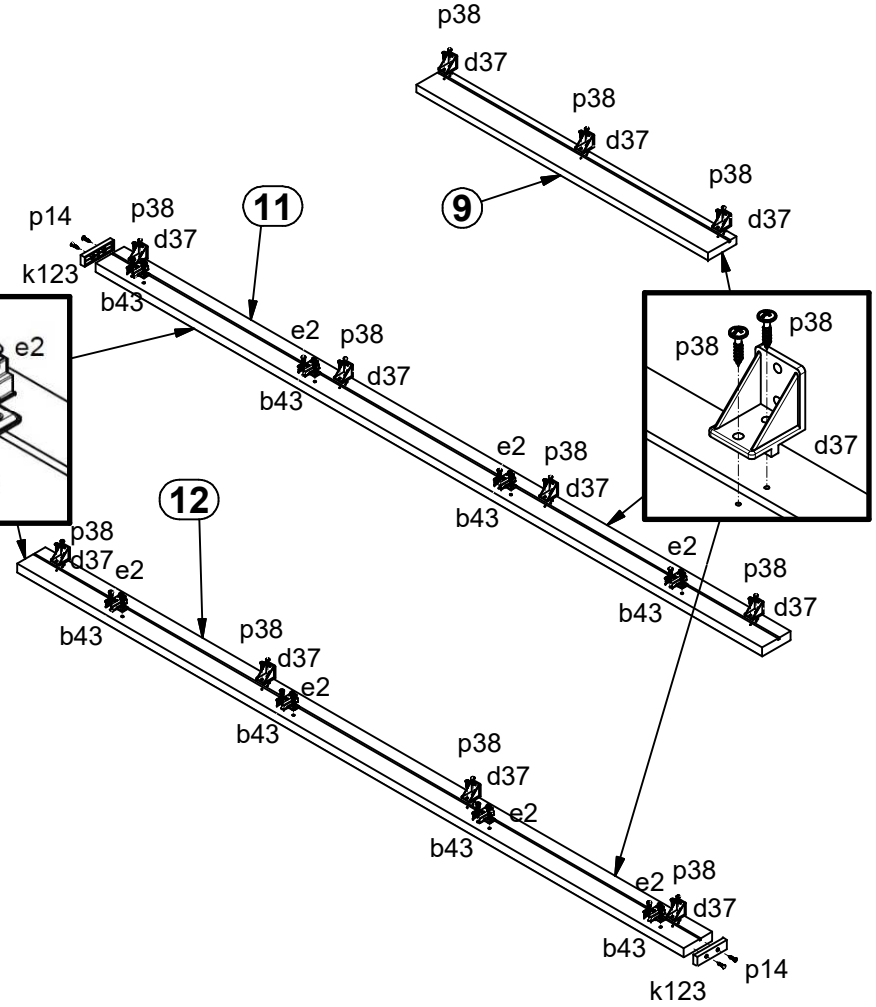
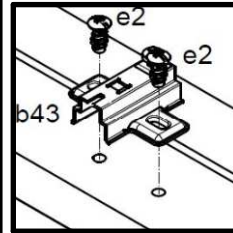

5

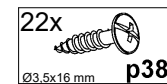
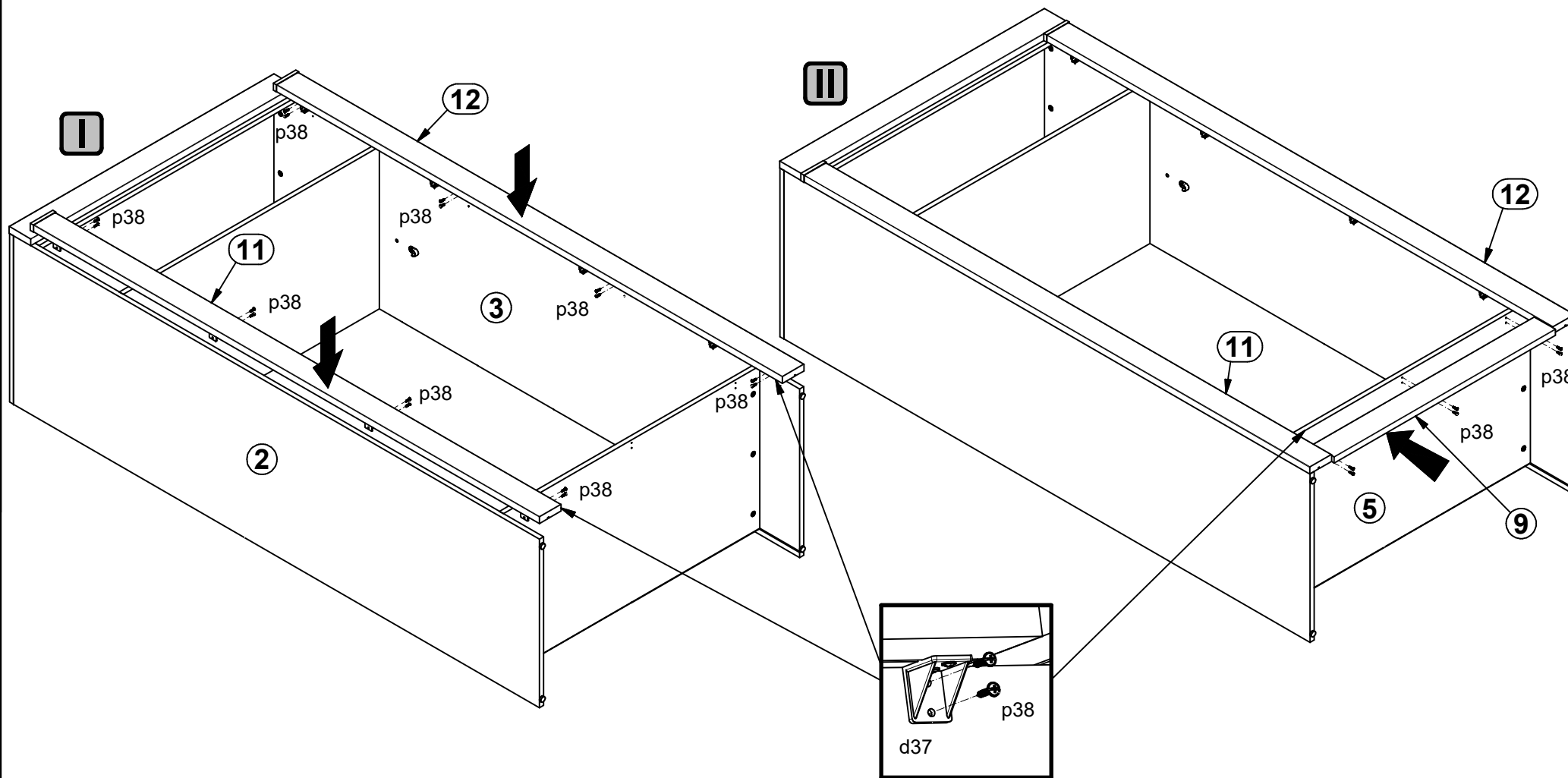

6

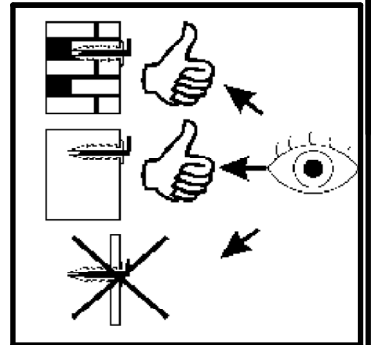
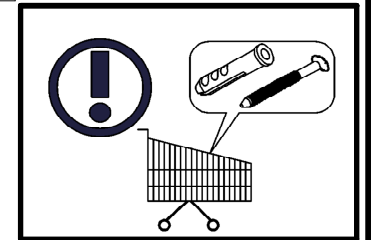
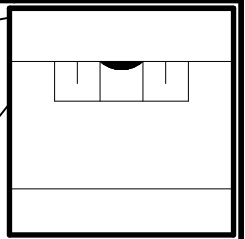
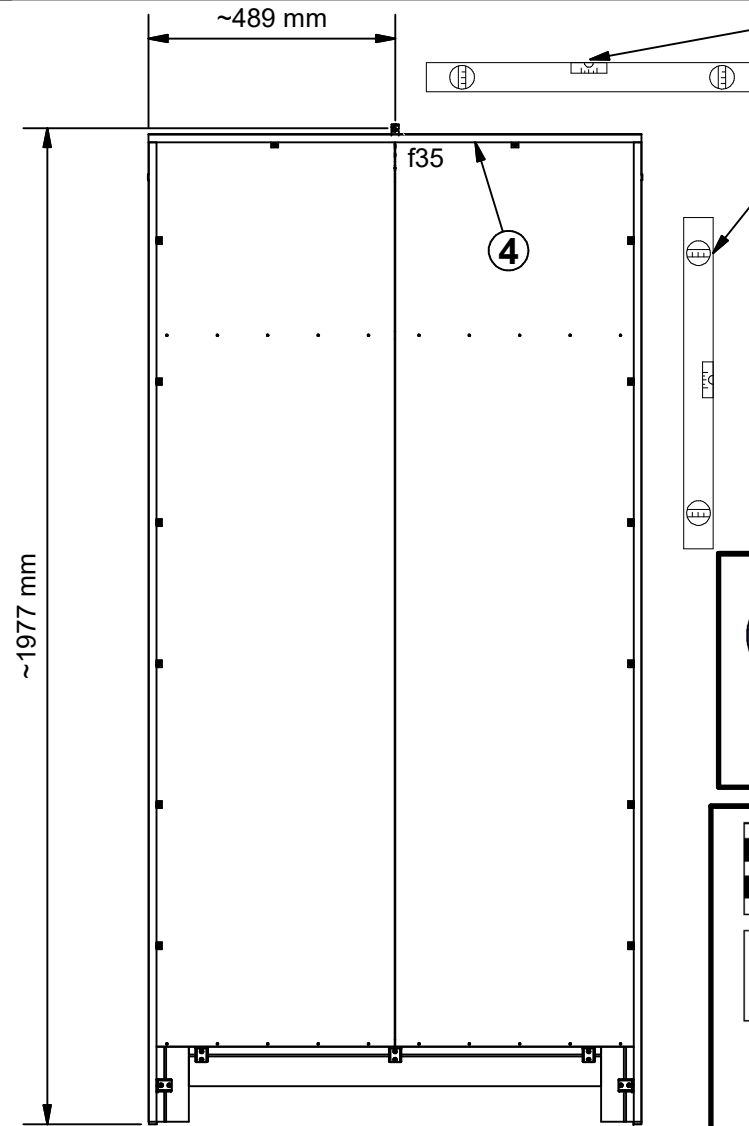
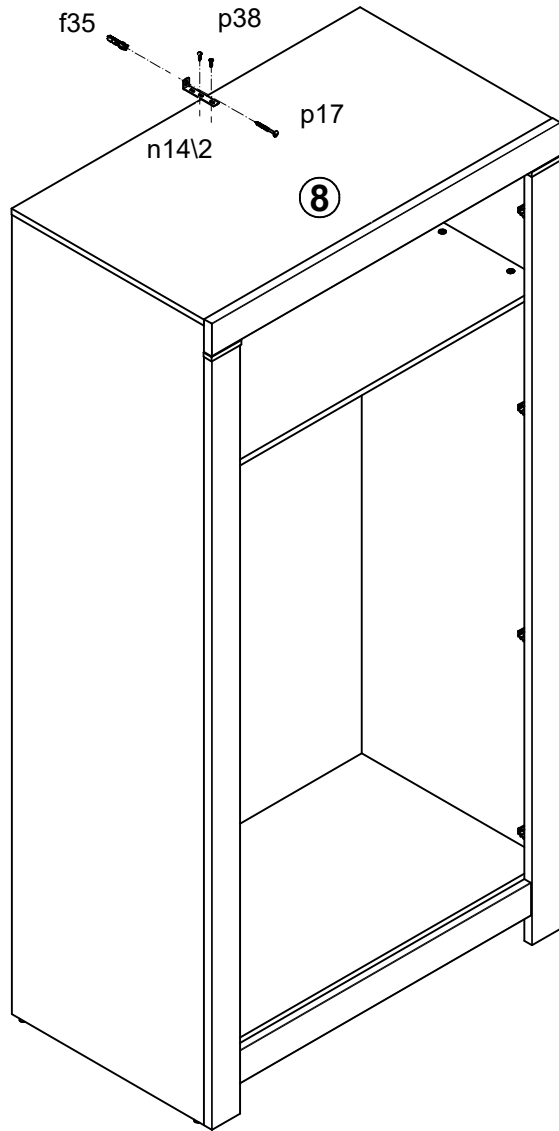

- 1x f35
- 1x n14\2
- 1x p17
- 2x p38

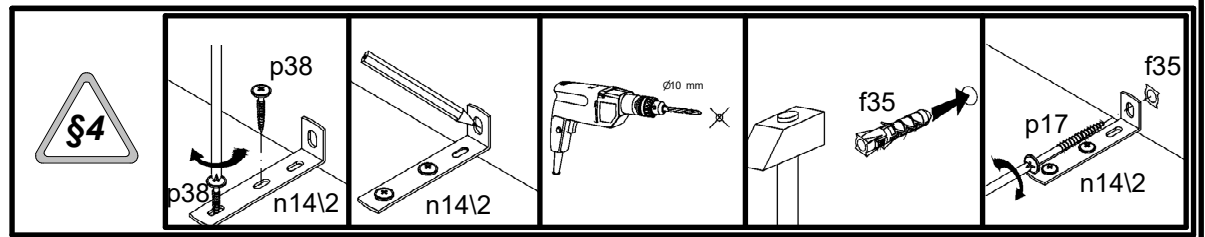

7

