

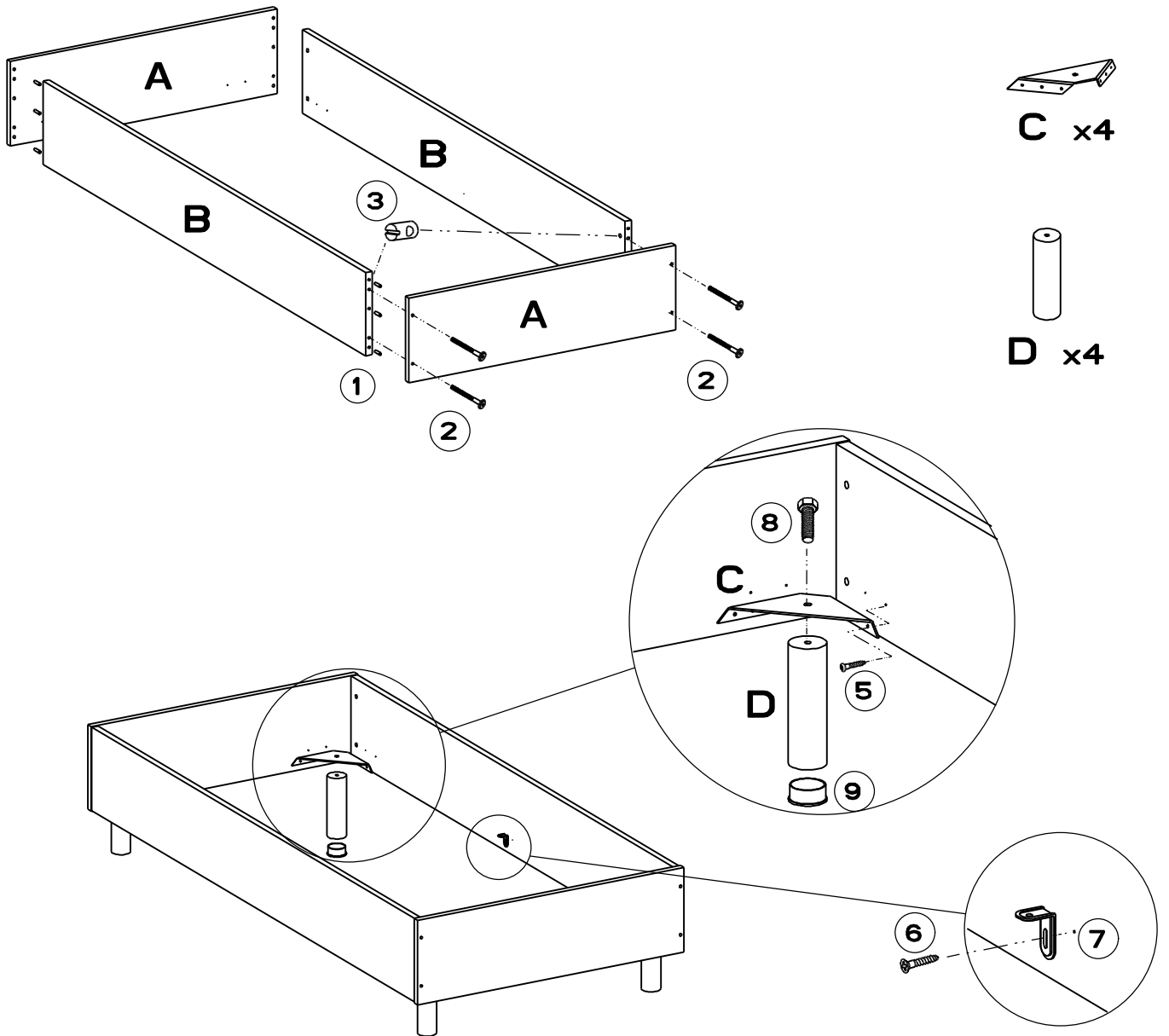









NR. 318



- | | | | | | | | | |
|---|---|---|---|---|--|---|---|---|
|  |  |  |  |  |  |  |  |  |
| 1 | 2 | 3 | 4 | 5 | 6 | 7 | 8 | 9 |
| x12 | x8 | x8 | x1 | x24 | x4 | x2 | x4 | x4 |