



www.MLMEBLE.pl

GB

D

CZ

SK

RUS

LT

assembly instructions / montageanleitung / montážní návod / montážny návod / инструкции по монтажу / surinkimo instrukcija



INSTRUKCJA MONTAŻU

RELAX 01

↑ 198 → 80 ↗ 51

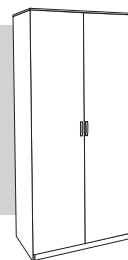

akcesoria / accessories / zubehör / příslušenství / príslušenstvo / аксессуары / furnitūra :



<p>x 16</p> <p>KK 8/32</p>	<p>x 9</p> <p>KT 7/50</p>	<p>x 9</p> <p>ZAK</p>	<p>x 1</p> <p>klej / glue / kleber / lepidlo / lepidlo / клей / kljaj</p>	<p>x 60</p> <p>GZ 1,4/25</p>	<p>x 1</p> <p>kluczyk / key / schlüssel / klíč / klūč / ключ / raktas</p>	<p>x 16</p> <p>WT 3,5x16</p>	<p>x 4</p> <p>WT 4x27</p>
<p>x 6</p> <p>PK H-0</p>	<p>x 6</p> <p>ZA 110°</p>	<p>x 3</p> <p>MD</p>	<p>x 2</p> <p>UT L96</p>	<p>x 8</p> <p>PA Ø3</p>	<p>x 1</p> <p>drażek / stick / stock / hūl / трость</p>	<p>x 2</p> <p>UB 0</p>	<p>x 12</p> <p>WE 6,3x13</p>
<p>x 6</p> <p>SG</p>	<p>x 1</p> <p>LT</p>						

do montażu potrzebne są:

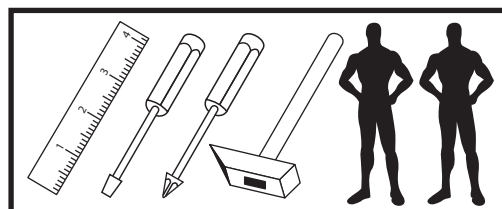
are needed for assembly:
sind erforderlich für die montage:
jsou potřebné pro montáž:
sú potrebné pre montáž:
которые необходимы для сборки:
Surinkimui reikės

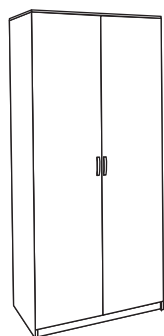



	CODE			
1	RELAX01_01	1956	490	1
2	RELAX01_02	1525	404	1
3	RELAX01_03	800	507	1
4	RELAX01_04	766	490	1
5	RELAX01_05	315	402	2
6	RELAX01_06	1890	396	2
7	RELAX01_07	766	405	1
8	RELAX01_08	1956	490	1
9	RELAX01_09	766	60	2
10	RELAX01HDF_01	1909	395	2
11				
12				
13				
14				
15				

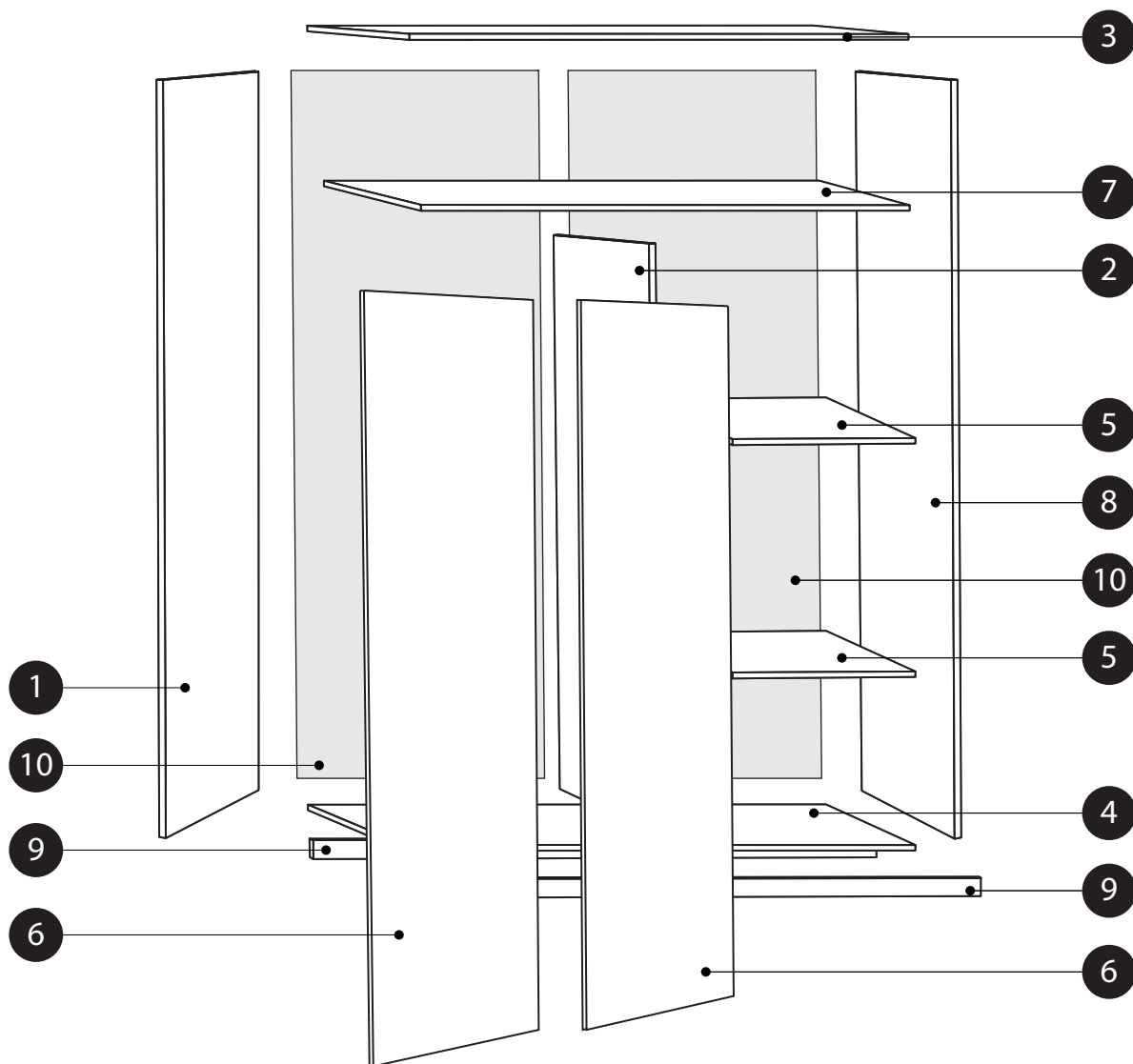

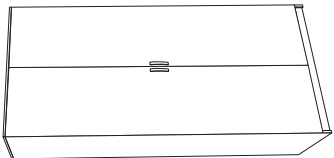

UWAGA! - w pierwszej kolejności wbijamy akcesoria "KK"! "MD" w białej oraz boki.
WARNUNG! - Die erste Accessoire-Sticks "KK" und "MD" in den Spitzen und an den Seiten.
POZOR! - První příslušenství holiť "KK" a "MD" v korunách a boky.
POZORI! - Prve príslušenstvo palíc "KK" a "MD" v korunách a boky.
БІГМАННІ! - Перші аксесуарів наочки "KK" і "MD" по верхам і по бокам.
DĚMESIO! - První příslušenství KK ir MD įkalame į stalių ir šonus.

