

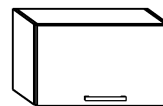

POLO - W600K

→60 ↑ 36 ↘34



x 8



(a)

x 2

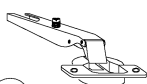

(b)

x 2

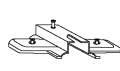

(c)

x 1



(d)

x 4



(e)

x 4 (4x16)



(f)

x 4 (3,5x30)



(g)

25 min

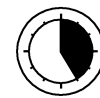
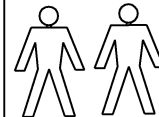

x 15



(h)

x 1



(i)

x 1

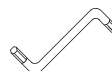

(j)

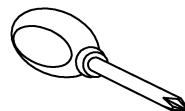
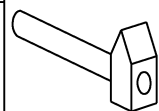

① - FAZY MONTAŻU

Ⓐ - OZNACZENIE ELEMENTÓW

Ⓐ - OZNACZENIE AKCESORIÓW

①

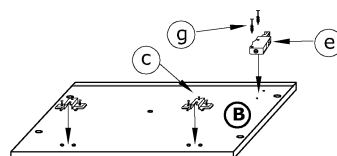
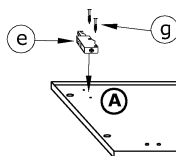

②

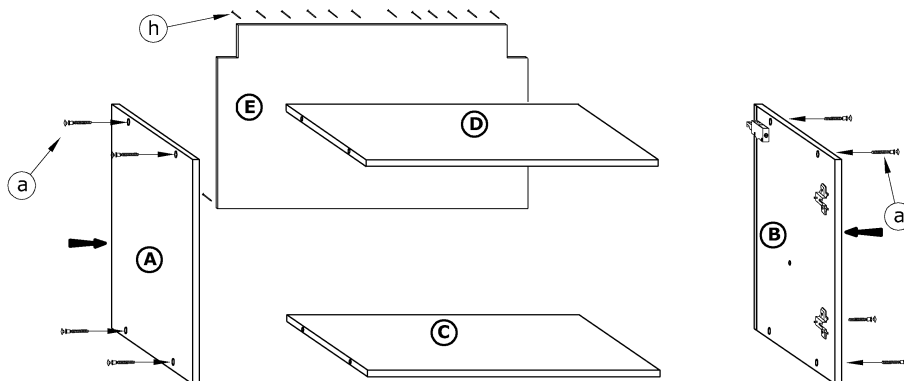

③

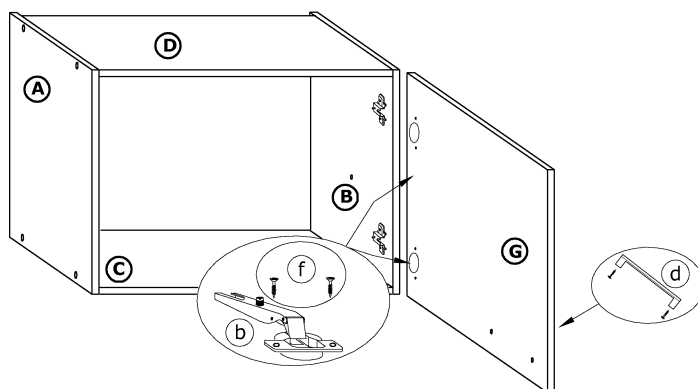

④

