

A	B	C (mm)		D
1	S263-1004	301	168	1/1
2	S263-1005	799	168	1/1
3	S263-1006	767	168	1/1
4	S263-1007	483	168	1/1
5	S263-2003	800	800	1/1
6	S263-2004	800	800	1/1
7	S263-4004	990	100	1/1
8	S263-4005	487	100	1/1

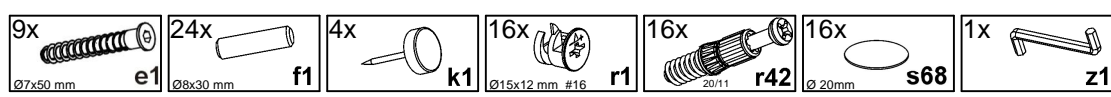

1

2x r1 2x f1

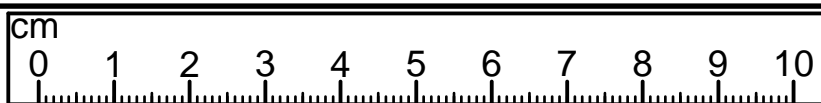
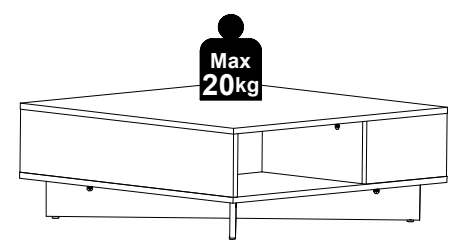
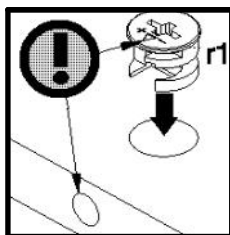
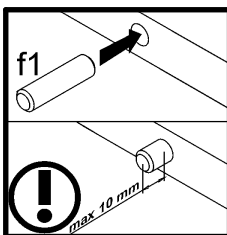
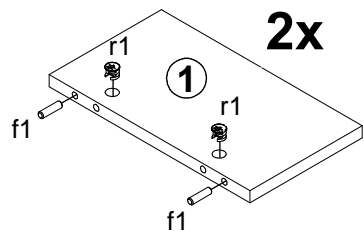

2x r1 4x f1

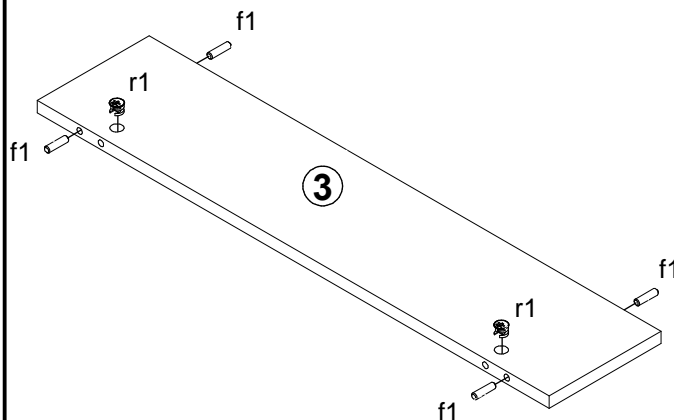

2x r1 4x f1

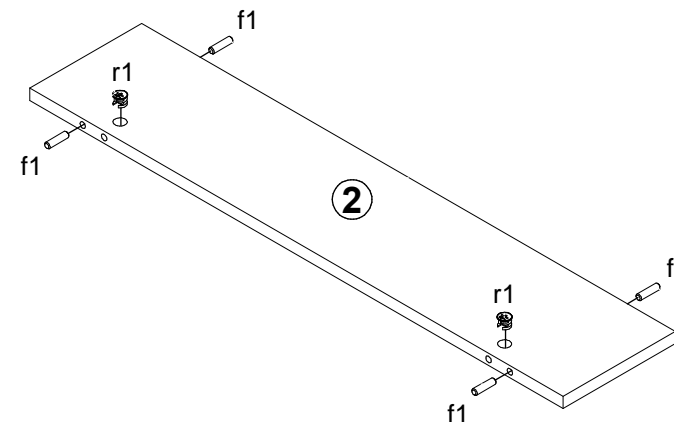

4x f1

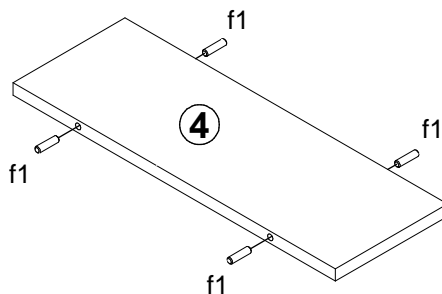

4x r1 4x f1

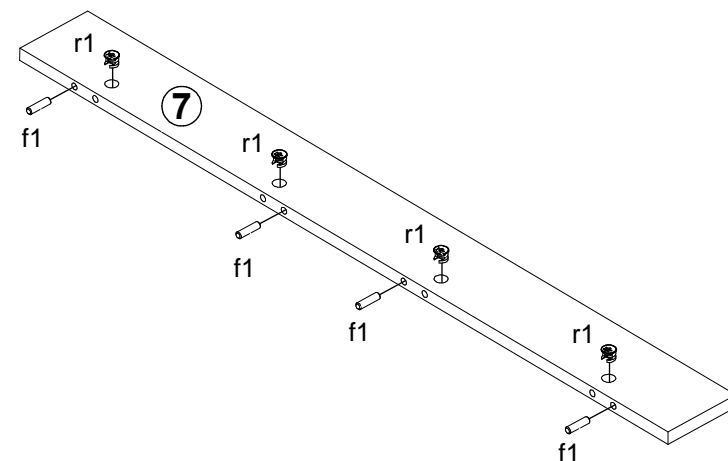

2x r1 2x f1

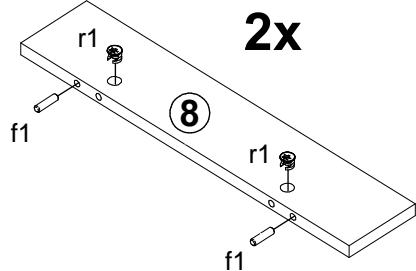

A

S263-LAW/3/8

4 / 6

1

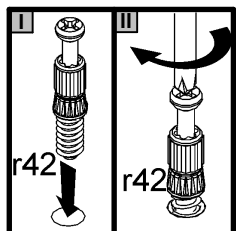
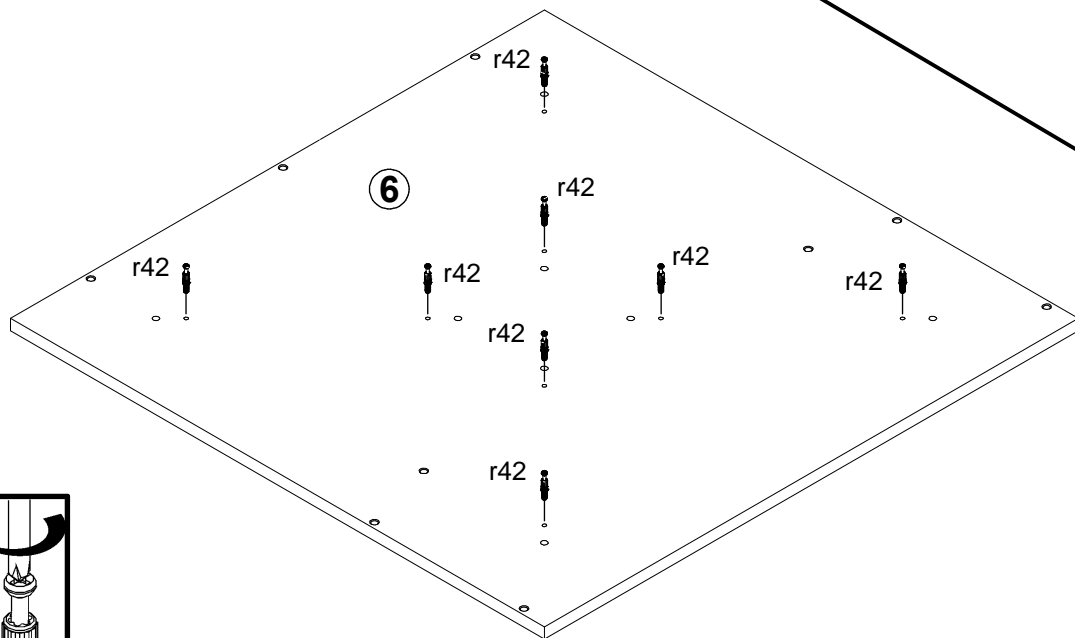
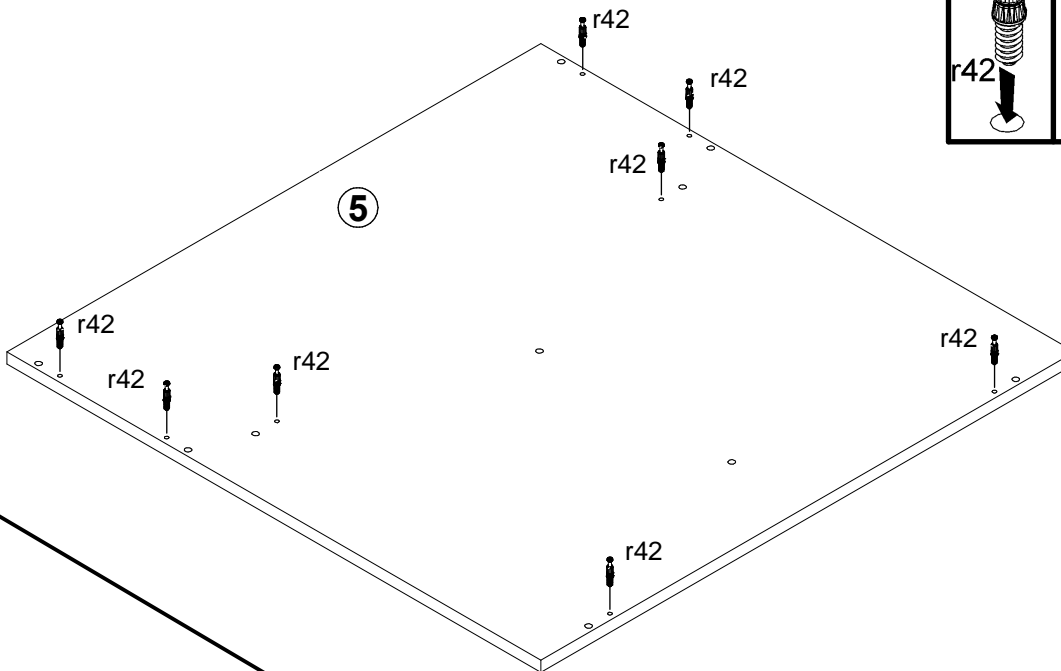
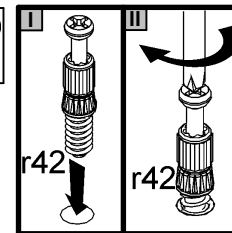
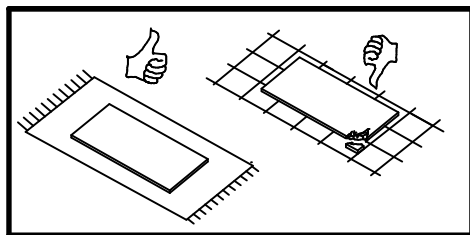

2 

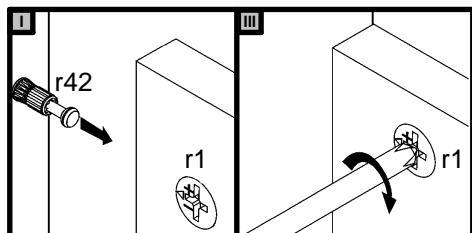
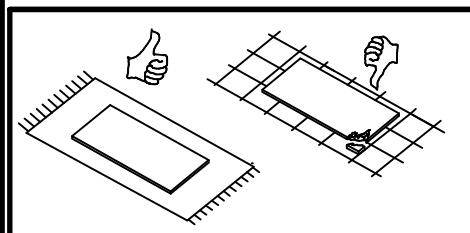
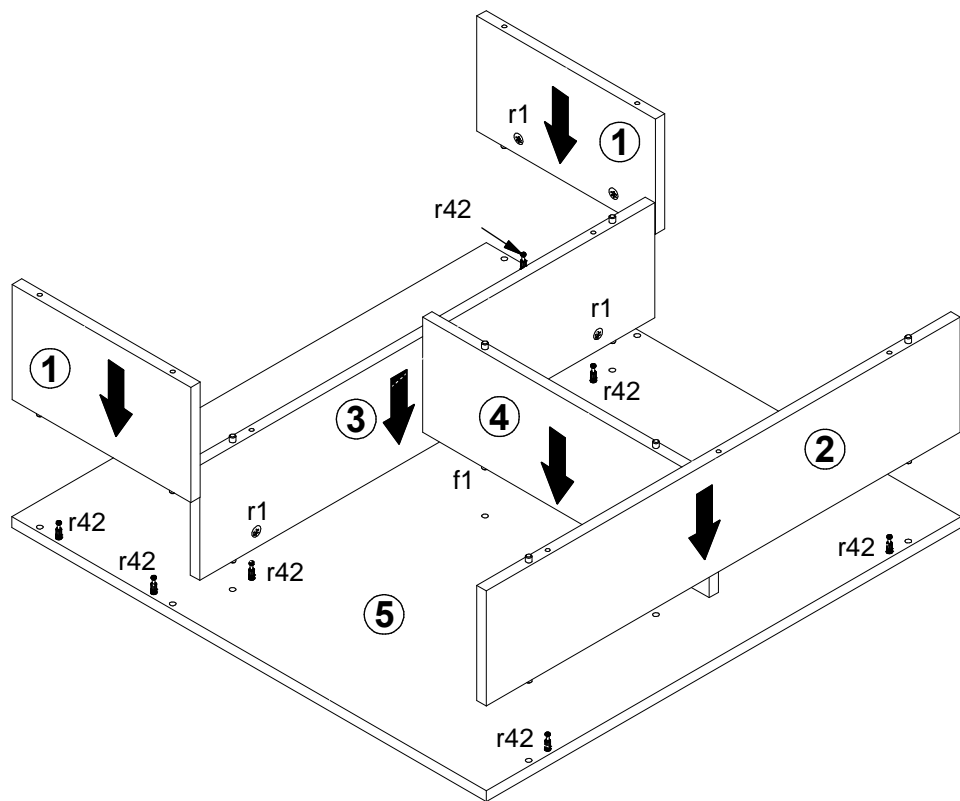

3

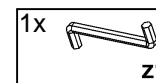
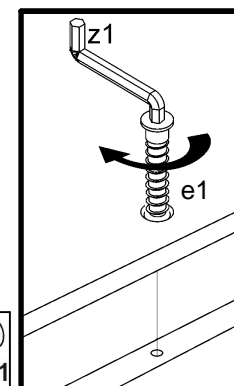
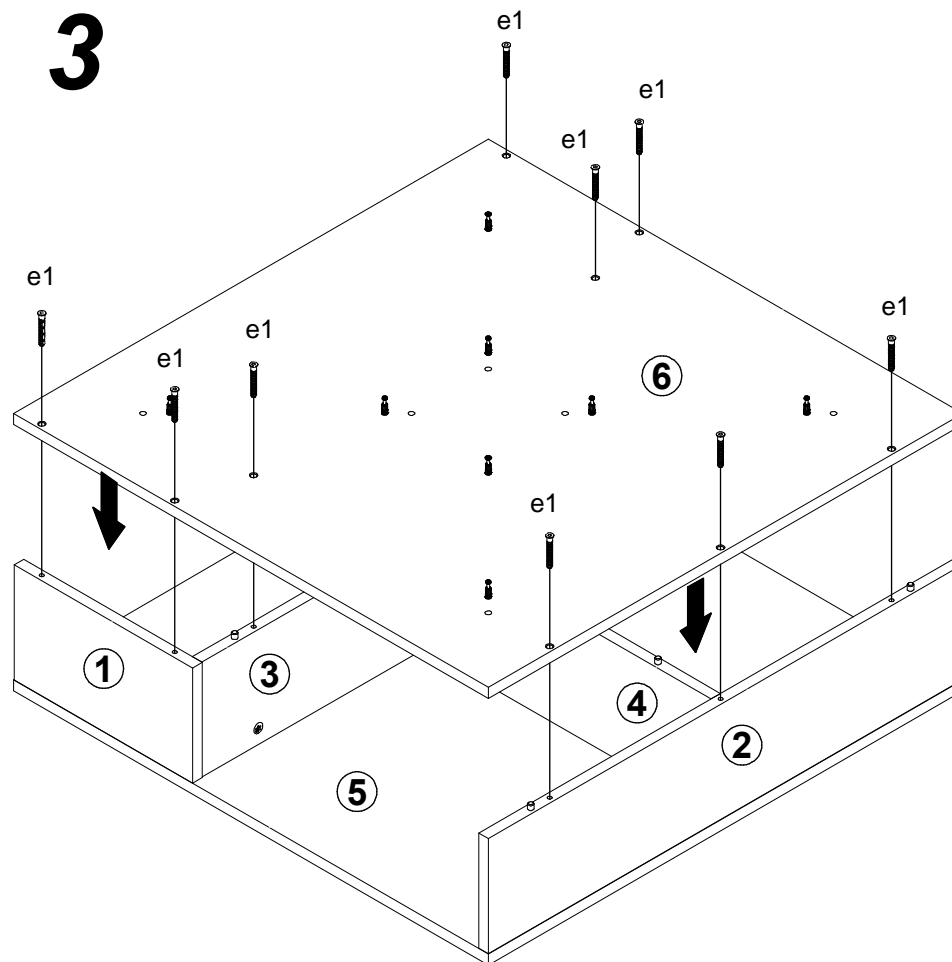

4

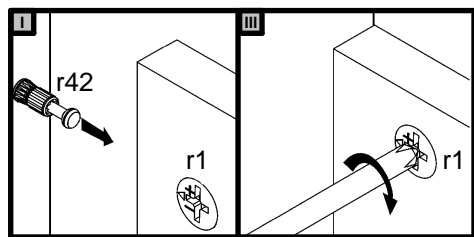
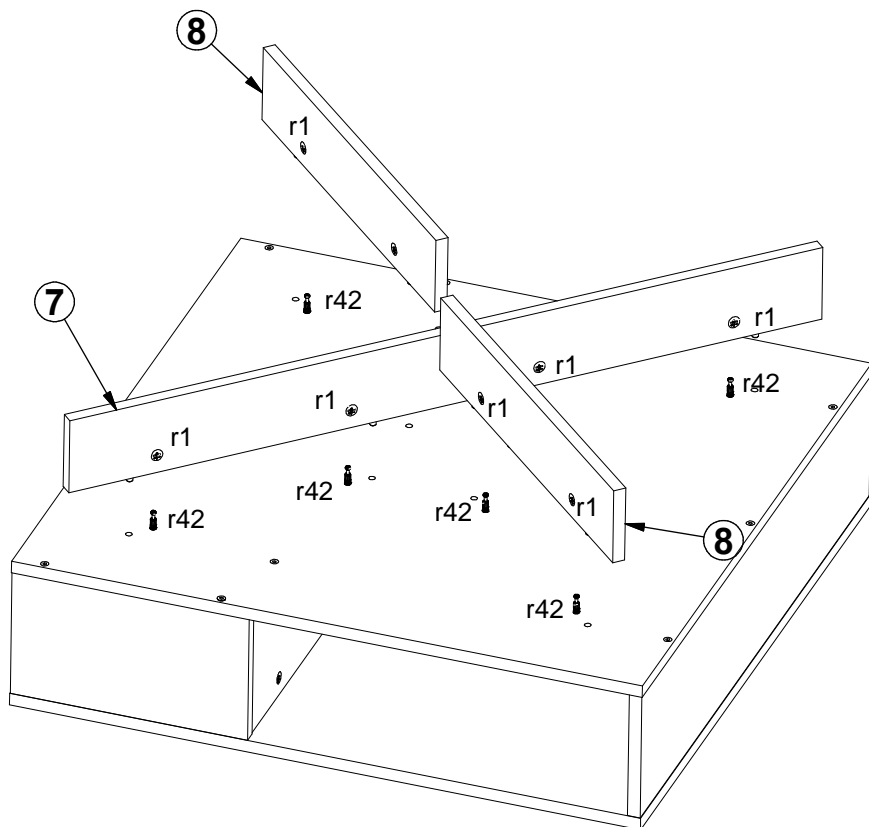

5

