

# 4085RC16

PARISOT S.A.S. 70800 SAINT LOUP SUR SEMOUSE -FRANCE-



Gamme : CELEBRITY



[www.parisot.com](http://www.parisot.com)

## FR Remerciements :

Nous vous remercions d'avoir choisi un meuble créé et fabriqué par le Groupe Parisot et espérons qu'il vous donnera entière satisfaction.

## EN Thanks:

Thank you for choosing furniture designed and manufactured by the Parisot Group. We hope you are totally satisfied with your purchase.

## DE Danksagung:

Wir danken Ihnen für den Kauf eines Frankreich von der Parisot-Gruppe entworfenen und hergestellten Möbelstücks und hoffen, dass Sie es zu Ihrer vollkommenen Zufriedenheit finden werden.

## HU Köszönet:

Köszönjük, hogy a Parisot Groupe által létrehozott és gyártott bútort választott, reméljük, hogy elégedett lesz a termékkel.

## PT Agradecimentos:

Obrigado por ter escolhido um móvel concebido e fabricado pelo Grupo Parisot, esperando que seja do seu inteiro agrado.

## IT Ringraziamenti:

Grazie per avere scelto un mobile progettato e fabbricato dal Gruppo Parisot.

Speriamo soddisfatti appieno le vostre esigenze.

## NL Bedankje:

Wij bedanken u voor de aankoop van een door de Groep Parisot ontworpen en vervaardigd meubel en hopen dat u er veel plezier aan zult beleven.

## CZ Poděkování:

Děkujeme, že jste si vybrali nábytek navržený a vyrobený společností Parisot Group. Doufáme, že budete svým nákupem naprosto spokojeni.

## ES Agradecimientos:

Les damos las gracias por haber elegido un mueble diseñado y fabricado por el Grupo Parisot y esperamos que sea de su total agrado.

## PL Podziękowania:

Dziękujemy za wybór mebli stworzonych i wyprodukowanych przez Grupę Parisot. Mamy nadzieję, że będziecie Państwo w pełni zadowoleni z zakupu.

## RO Mulțumiri:

Vă mulțumim că ați ales un articol de mobilier conceput și fabricat de Grupul Parisot și sperăm că veți fi pe deplin satisfăcuți de acesta.

## RU Благодарность:

Мы благодарим вас за то, что вы выбрали мебель, созданную и произведенную Групп Паризо, и надеемся, что вы будете полностью удовлетворены нашей продукцией.

## SK Pod'akovanie:

Dakujeme, že ste si vybrali nábytok navrhnutý a vyrobený spoločnosťou Parisot Group. Dúfame, že budete svojim nákupom absolútne spokojní.

## TR Teşekkür ederiz:

Parisot Group tarafından tasarlanan ve üretilen bu mobilyayı seçtiğiniz için teşekkür ederiz. Ürünümüzden memnun kalmanızı ümit ederiz.

## ZH 感谢 :

感谢您选择帕里索集团设计制造的家具。我们希望您对此次购买十分满意、

## AR : شكر :

نشكركم لاختياركم هذه القطعة من الأثاث من تصميم وتصنيع مجموعة باريزو Parisot ونتمنى أن تتال رضاءكم.

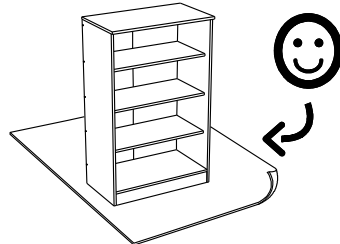
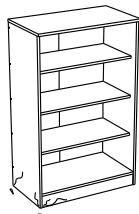
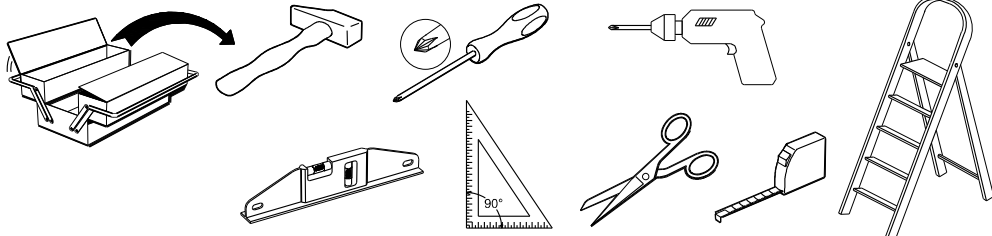

[contact@parisot.com](mailto:contact@parisot.com)

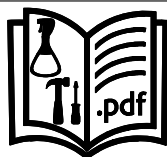

[www.parisot.com](http://www.parisot.com)

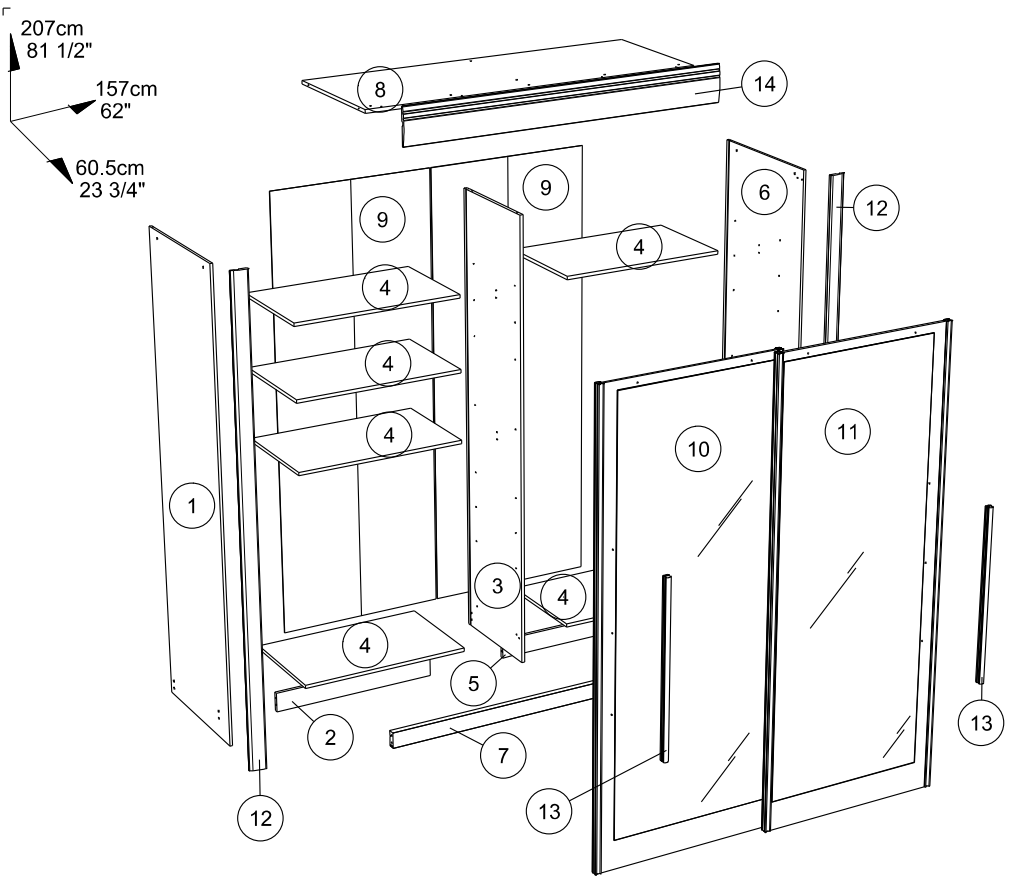

		mm			inch		
(13)	x 2	700	27	20	27 9/16	1 1/16	13/16
(5)	x 1	741	86	15	29 3/16	3 3/8	9/16
(2)	x 1	741	86	15	29 3/16	3 3/8	9/16
(4)	x 6	741	456	15	29 3/16	17 15/16	9/16
(14)	x 1	1425	160	16	56 1/8	6 5/16	5/8
(7)	x 1	1497	70	28	58 15/16	2 3/4	1 1/8
(8)	x 1	1497	564	15	58 15/16	22 3/16	9/16
(10)	x 1	1896	768	27	74 5/8	30 1/4	1 1/16
(11)	x 1	1896	768	27	74 5/8	30 1/4	1 1/16
(3)	x 1	1989	477	15	78 5/16	18 3/4	9/16
(6)	x 1	2028	592	12	79 13/16	23 5/16	1/2
(1)	x 1	2028	592	12	79 13/16	23 5/16	1/2
(12)	x 2	2067	72	19	81 3/8	2 13/16	3/4
(9)	x 2	2003	751	3	78 7/8	29 9/16	1/8

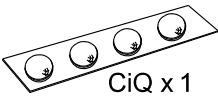

CiQ x1



WA x 12

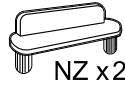

NZ x2



BIP x2

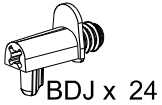

BDJ x 24



Ai x4



GZ x 4



CF x 2



HV x1



EP x16

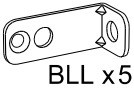

BLL x5

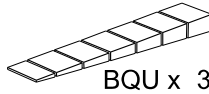

BQU x 3

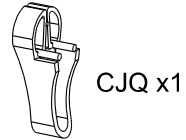

CJQ x1

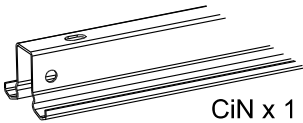

CiN x 1



DC x 2

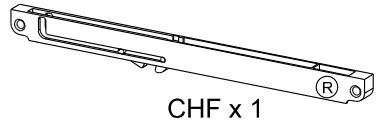

CHF x 1

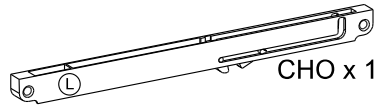

CHO x 1

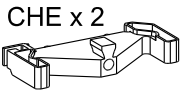
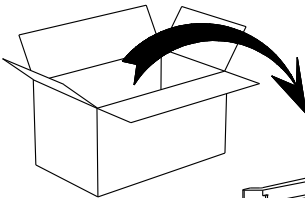

CHE x 2

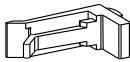

CGV x 1

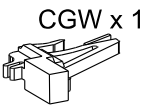

CGW x 1

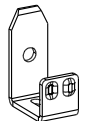

CHC x 2

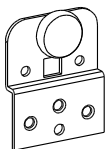

CiT x 4

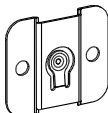

CHB x 4

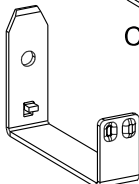

CiU x 2

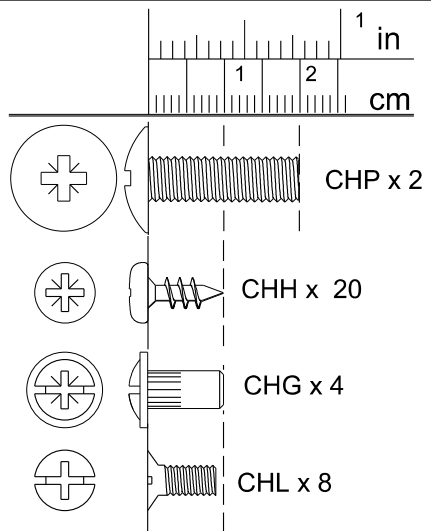

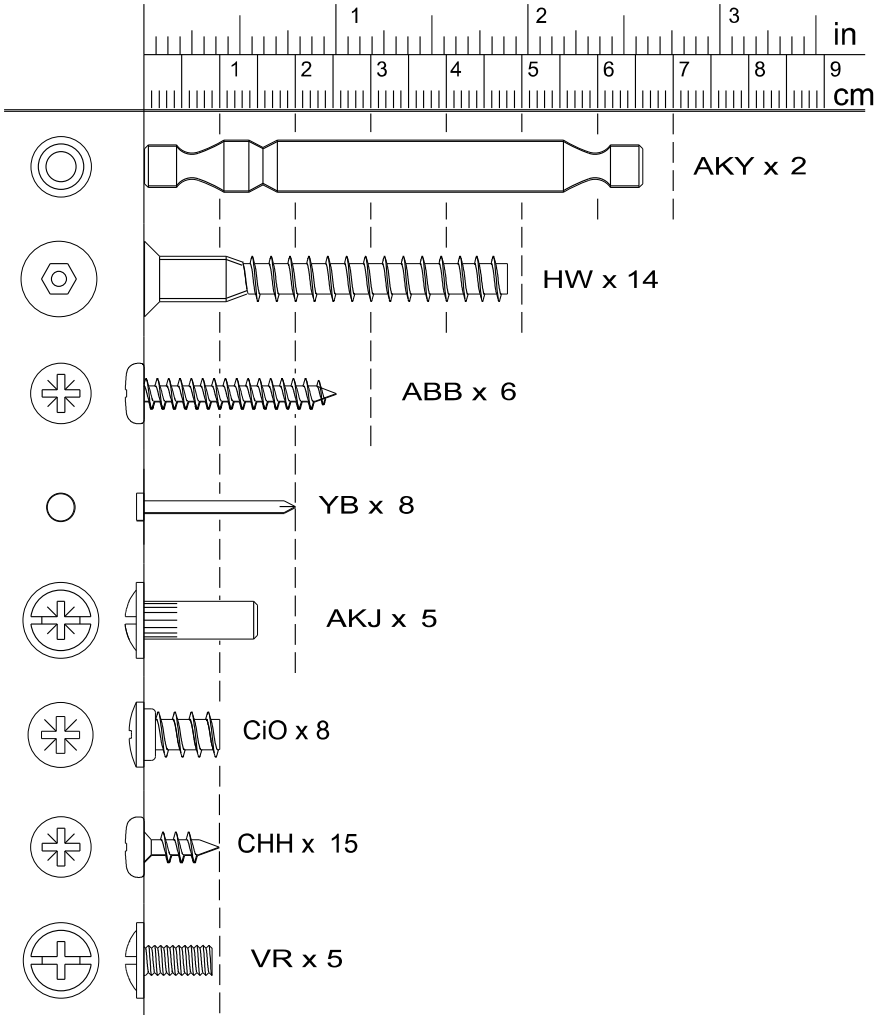

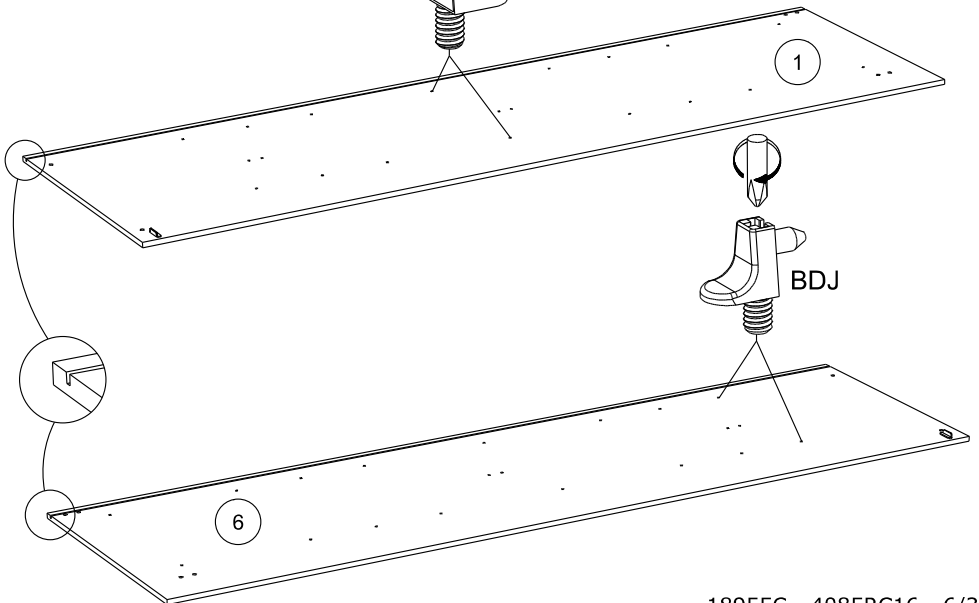
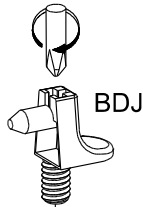
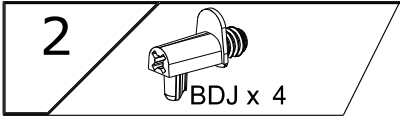
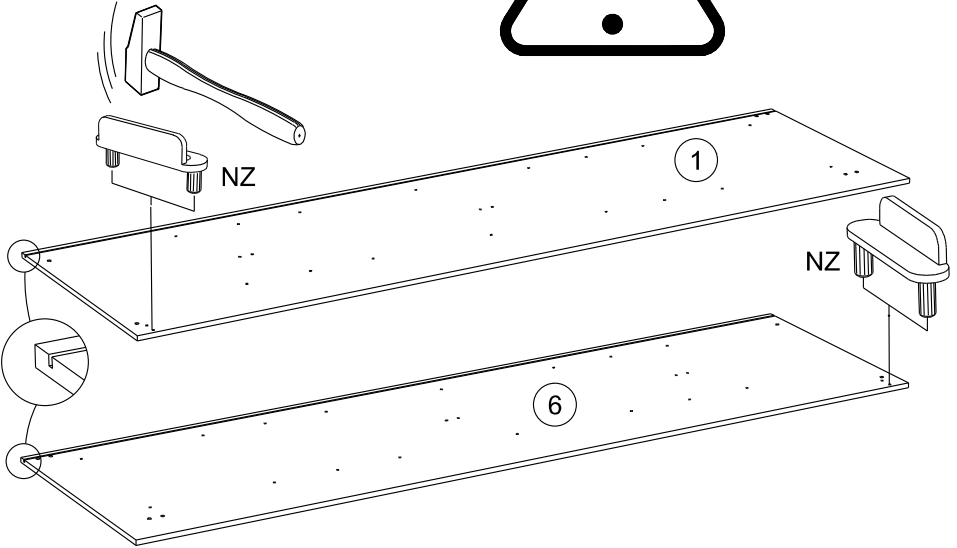
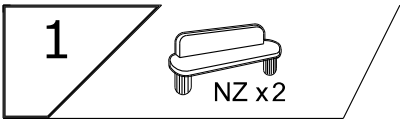

3



Ai x4

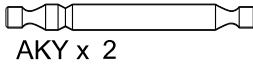

AKY x 2



HV x1

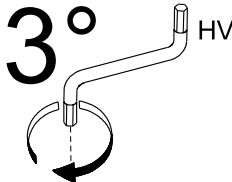
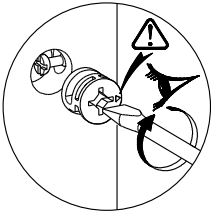

1°

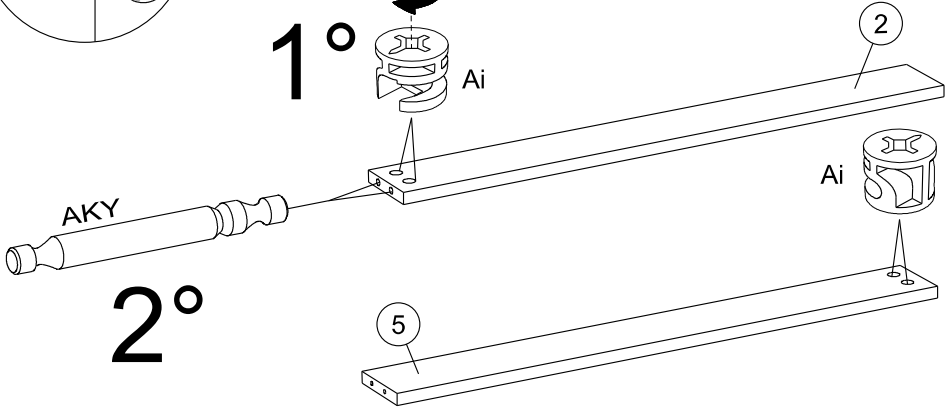

2°

4

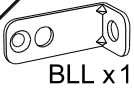

BLL x1



CiO x1



CHH x1

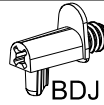

BDJ x 4

2° CHH

1° CiO

BLL

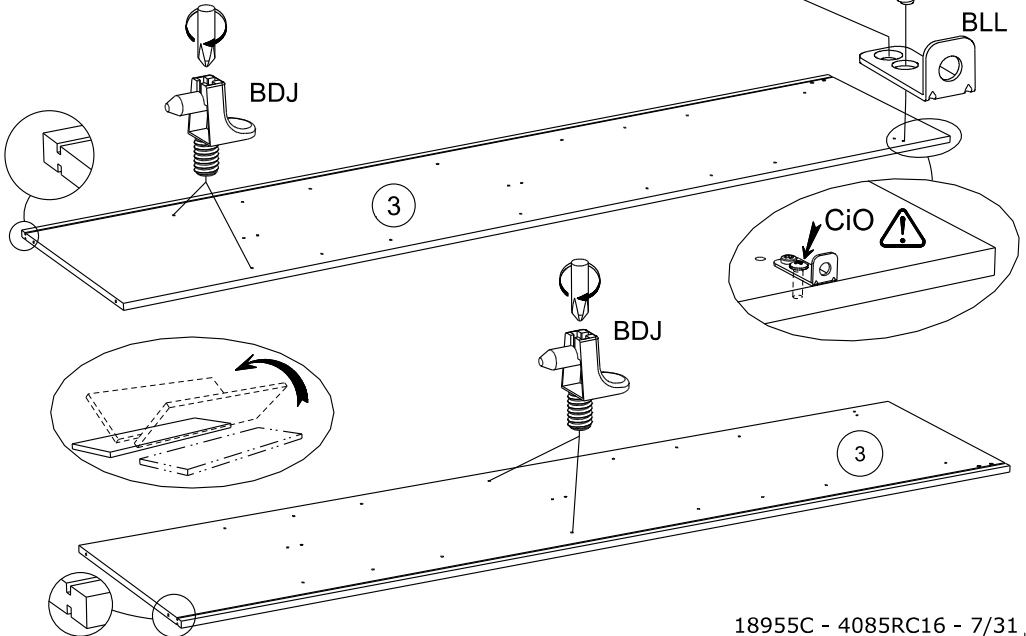

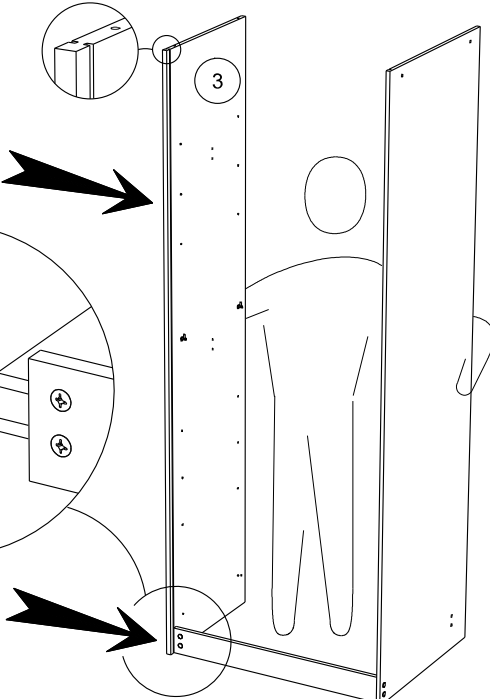
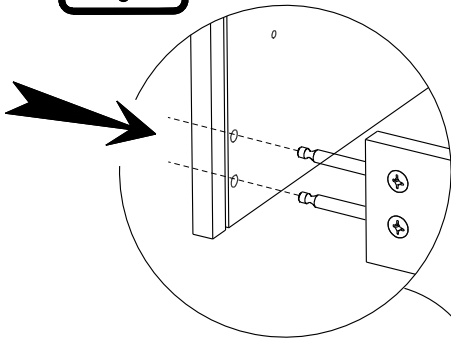
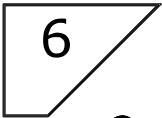
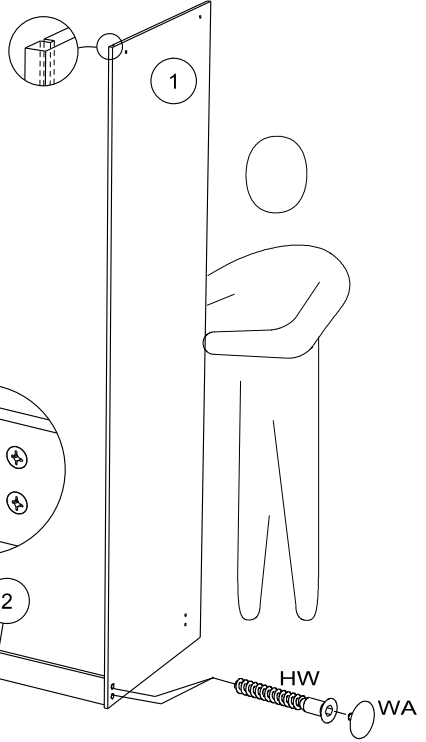
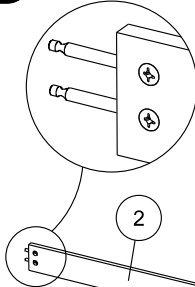
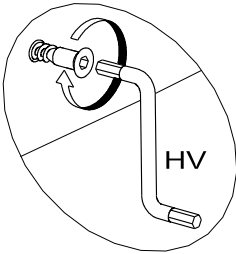
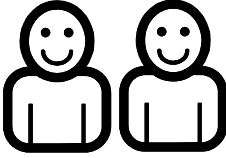
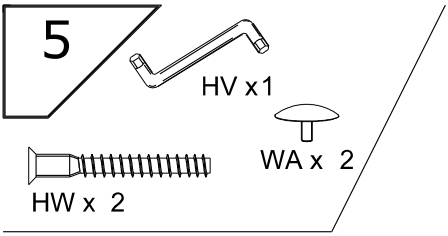



7

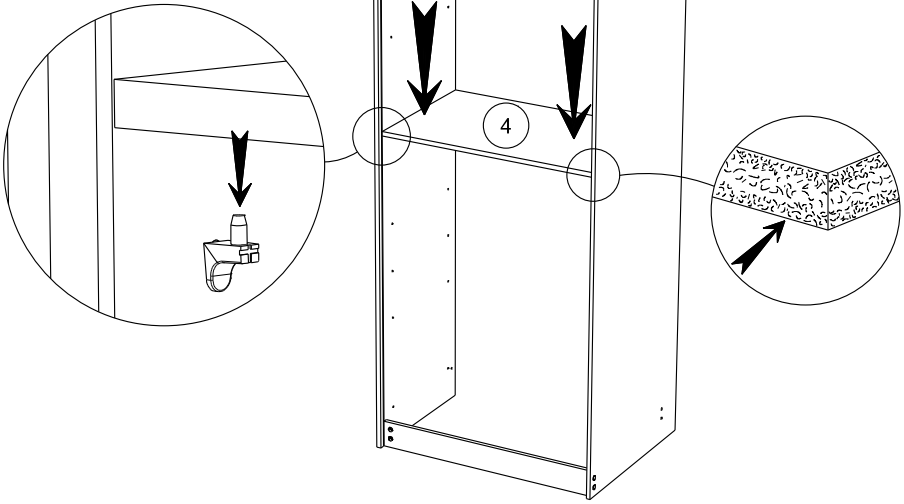

8

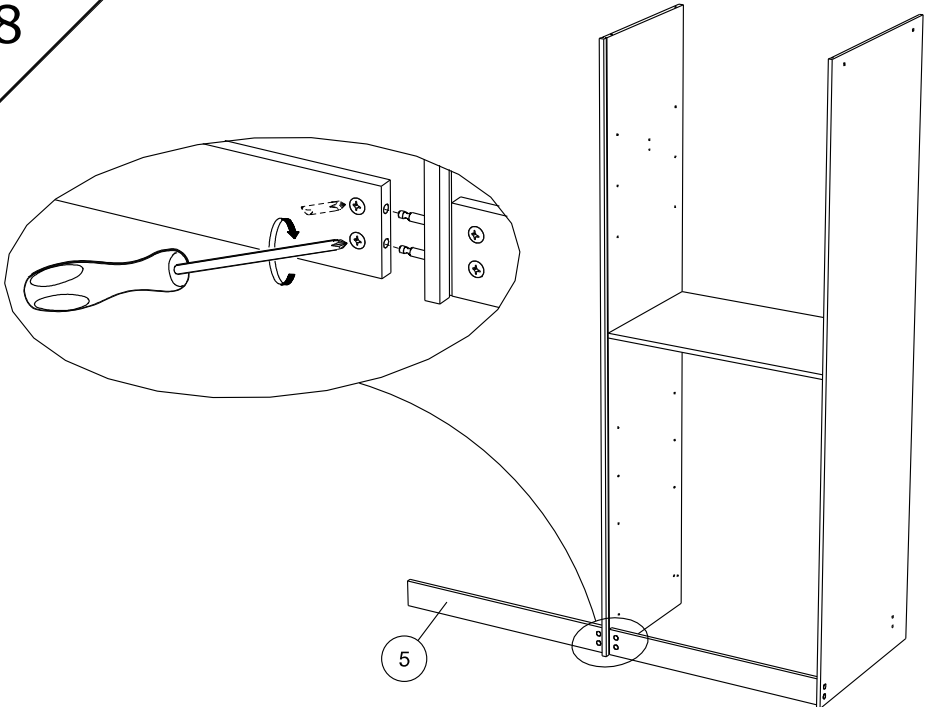

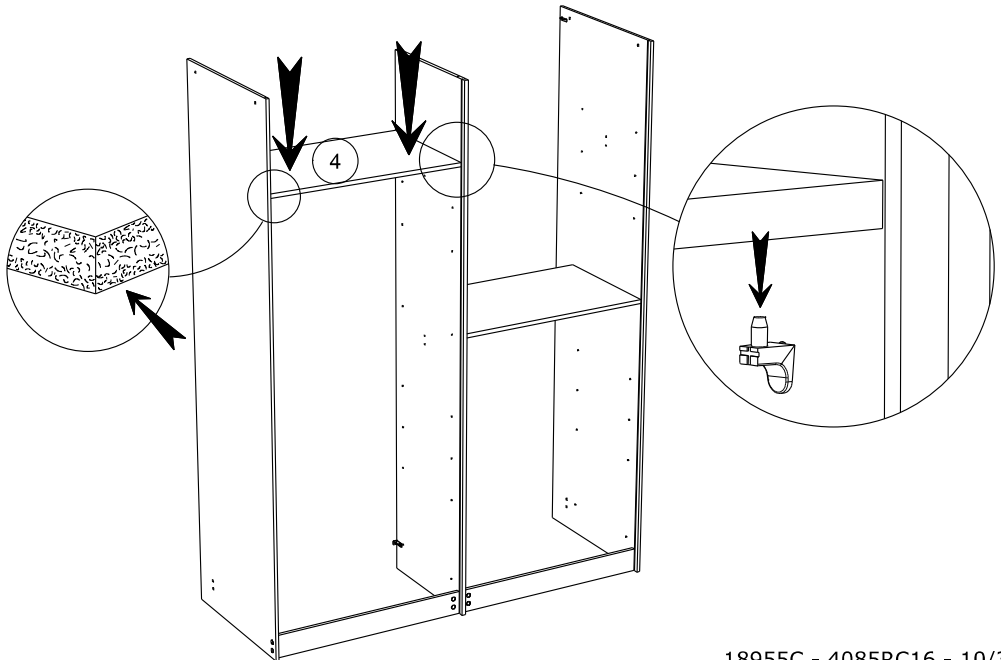
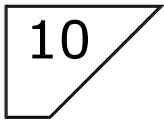
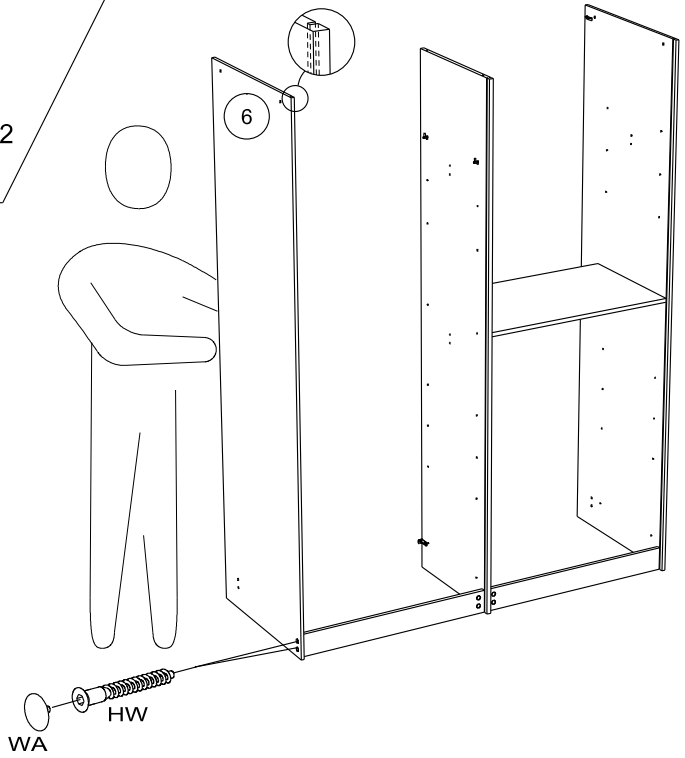
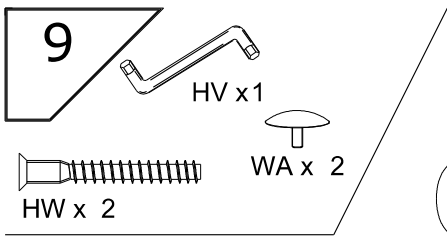

11

CiO x1

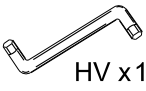

HV x1



WA x 4

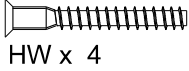

HW x 4

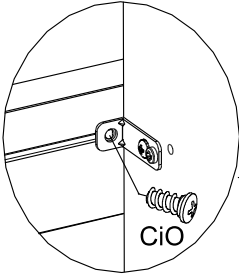

CiO

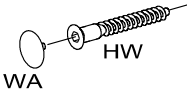

WA

HW

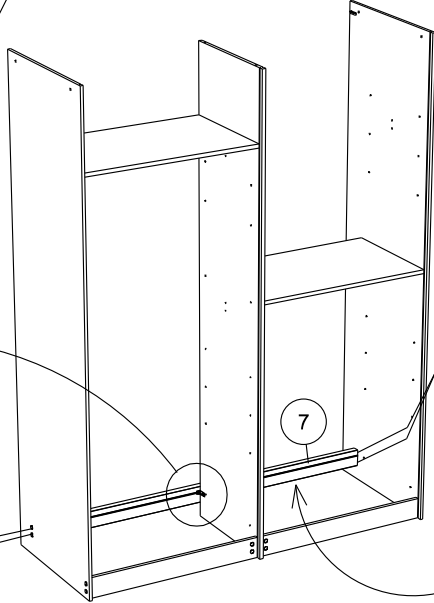

7

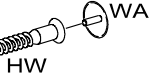

HW

WA

12

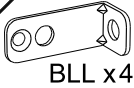

BLL x4



CiO x4

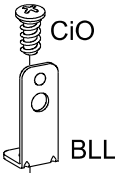

CiO

BLL

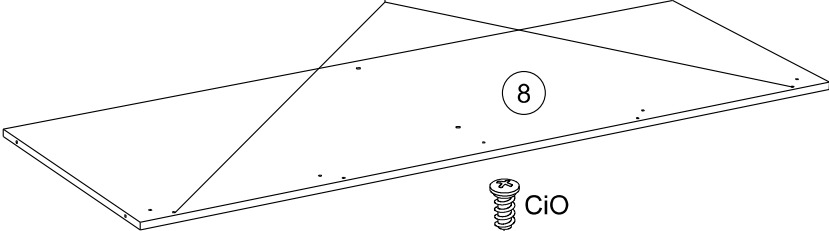

8

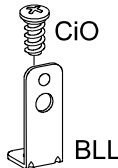

CiO

BLL

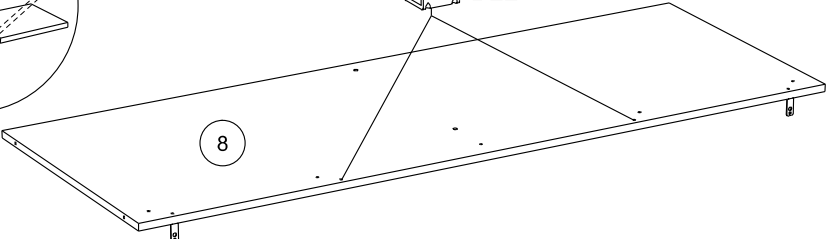
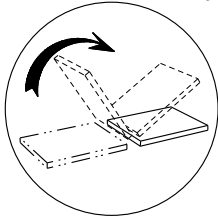

8

13

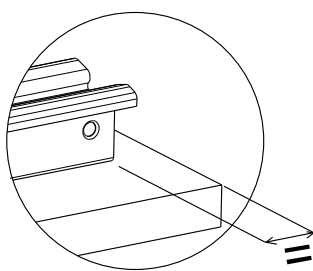
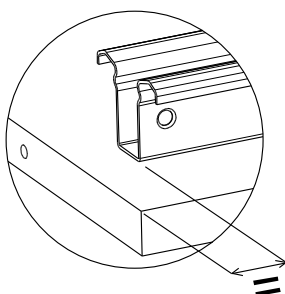
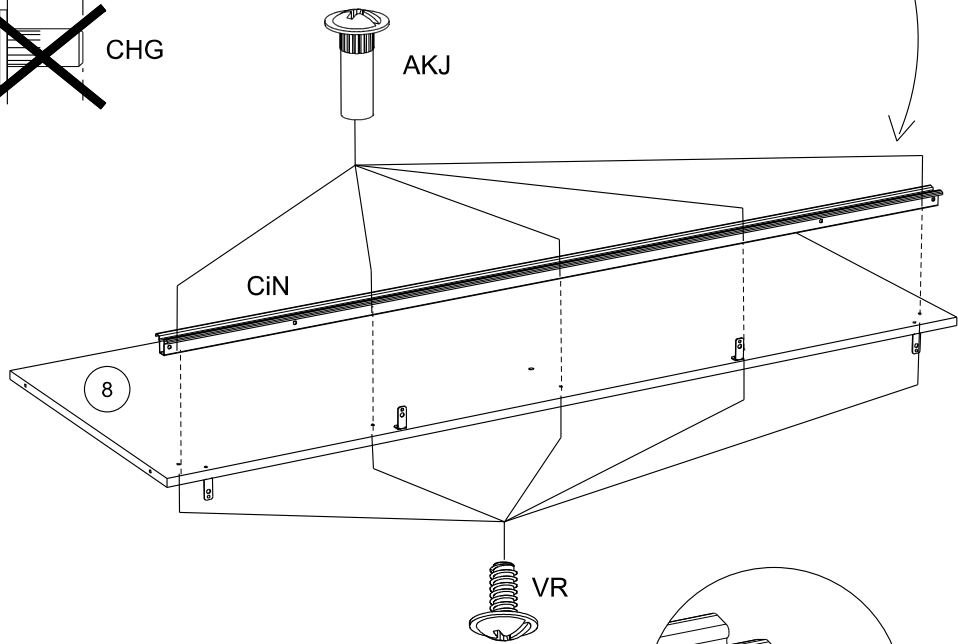
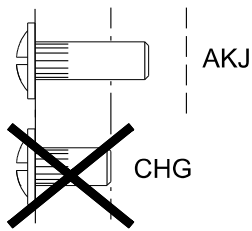
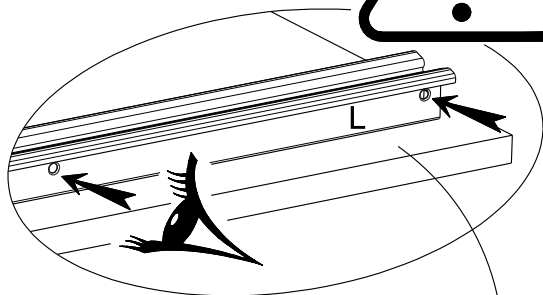
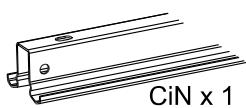
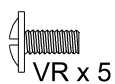
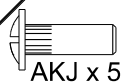

14

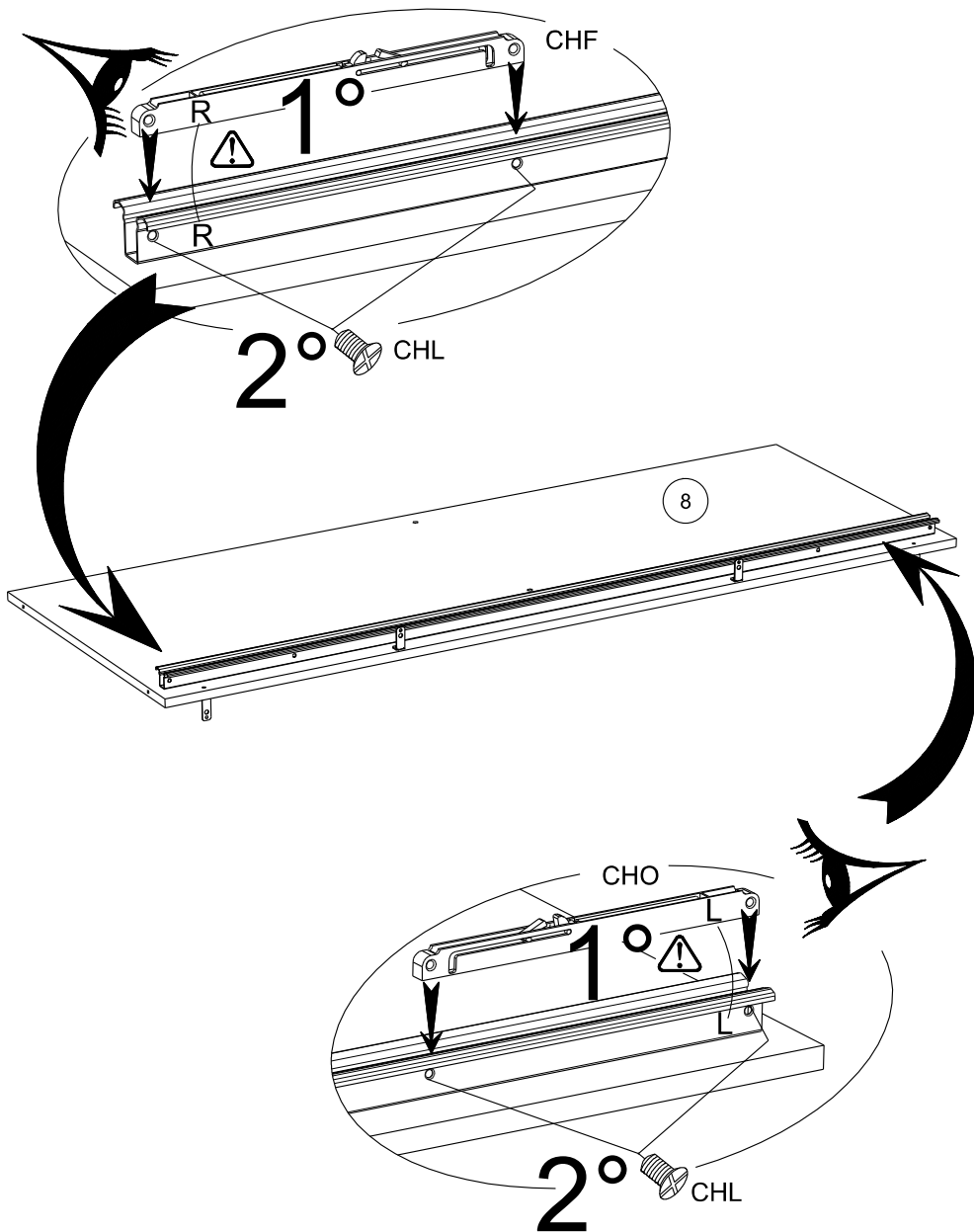
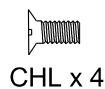
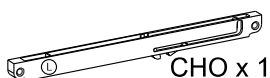

15



HV x1



WA x 4

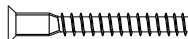

HW x 6

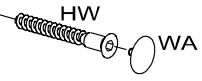
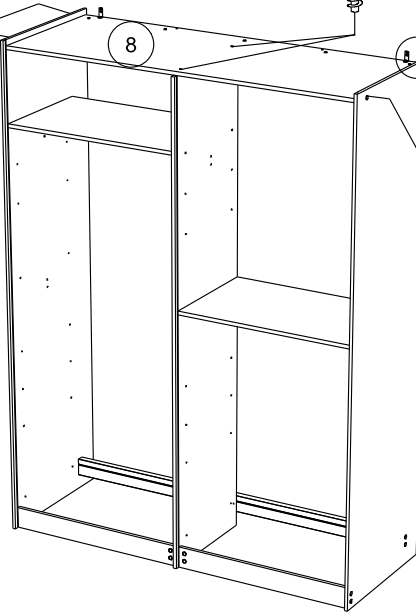
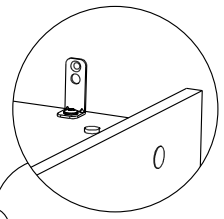
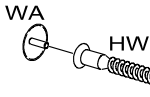

16

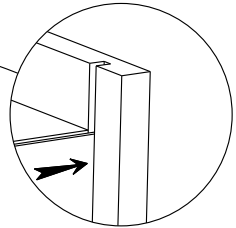
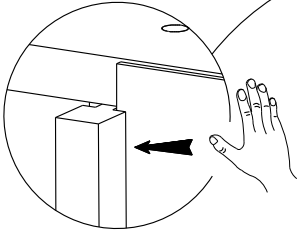
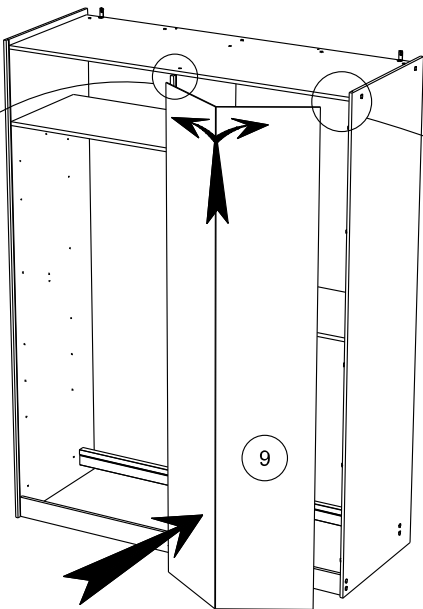

17

YB x 4

CJQ x 1

CHH x 4

EP x 8

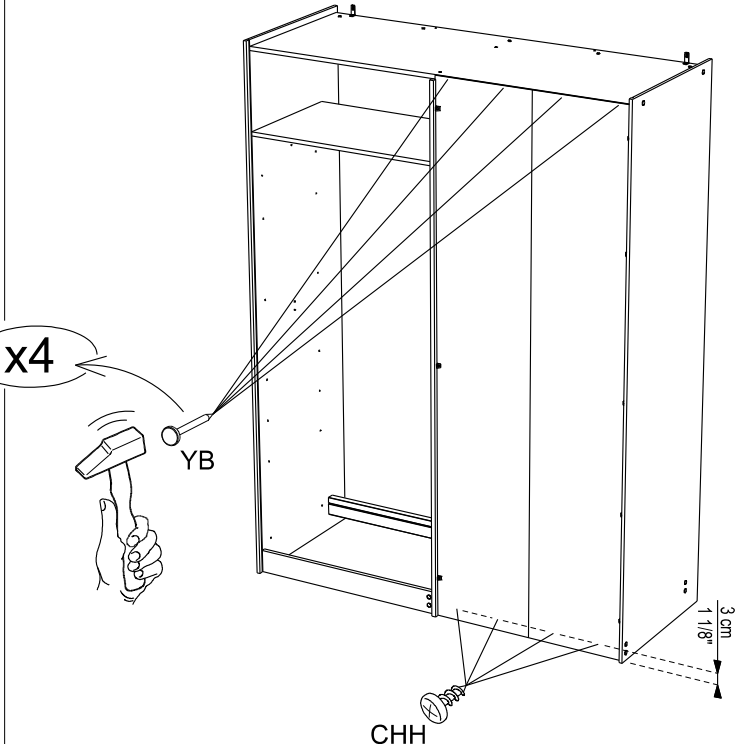
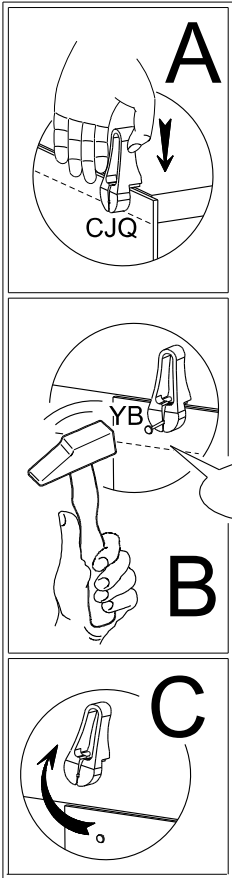
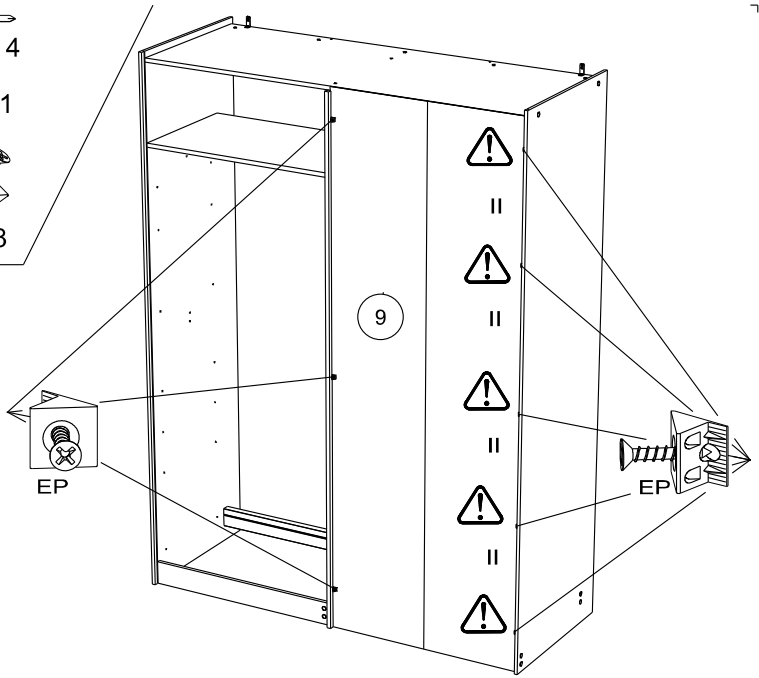

18

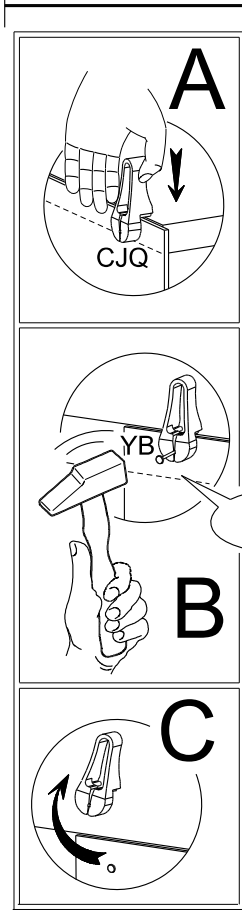
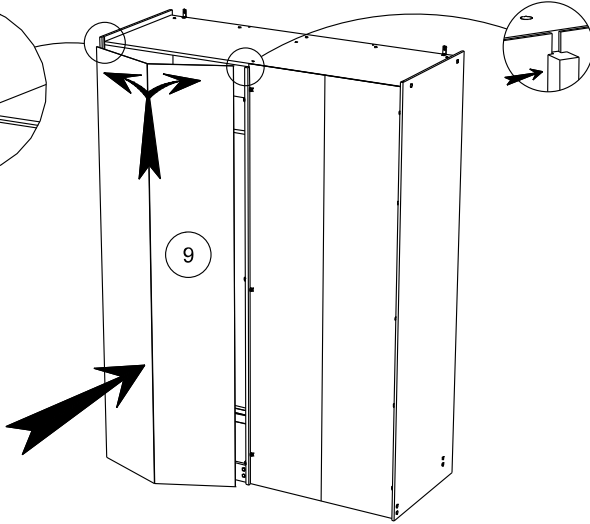
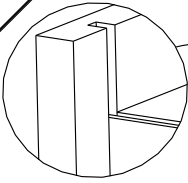

19  
CJQ x1

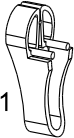

YB x 4

EP x 8

CHH x 4

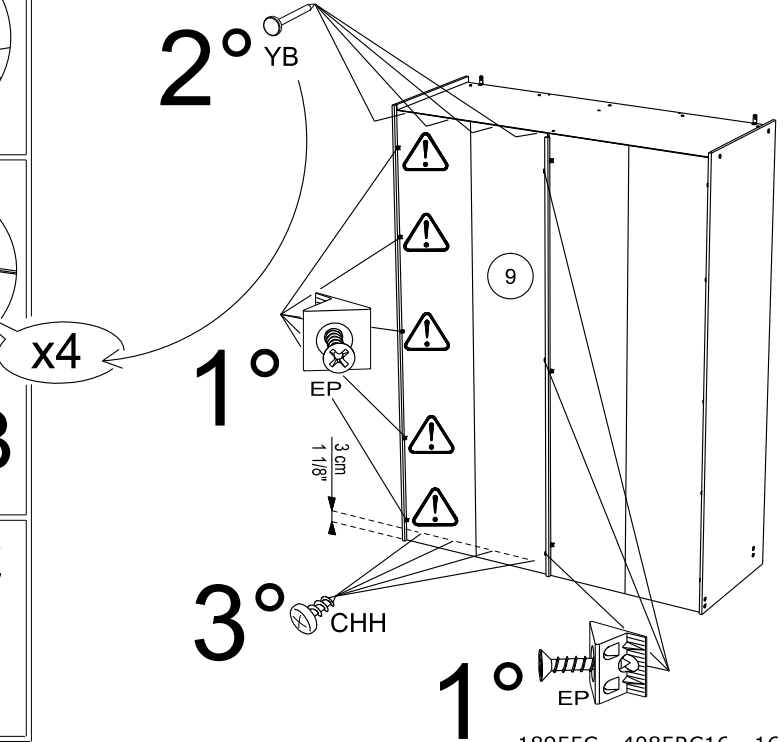



20

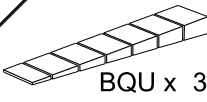

BQU x 3

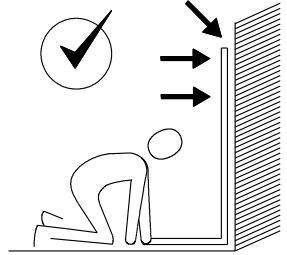

1°

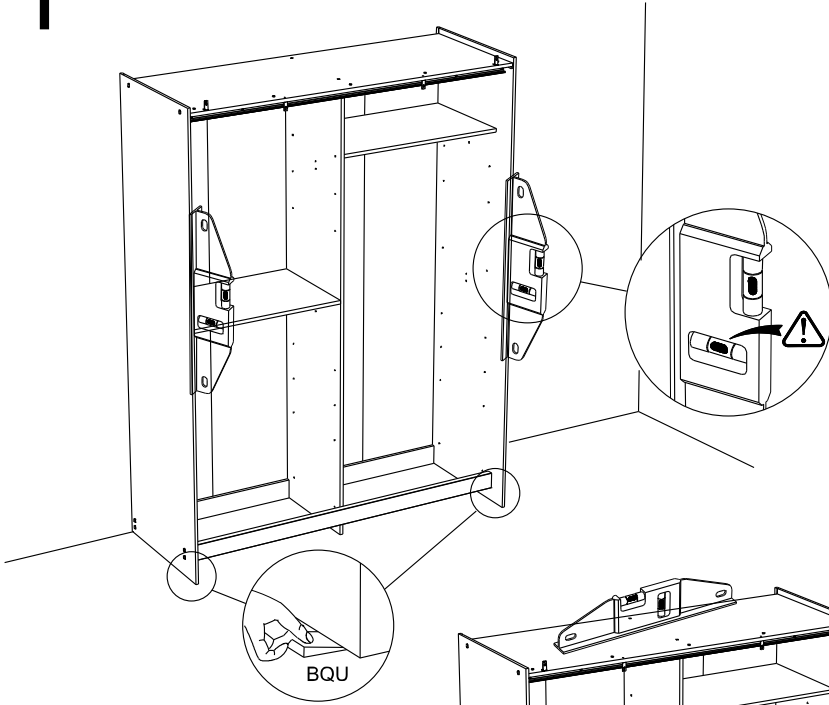

2°

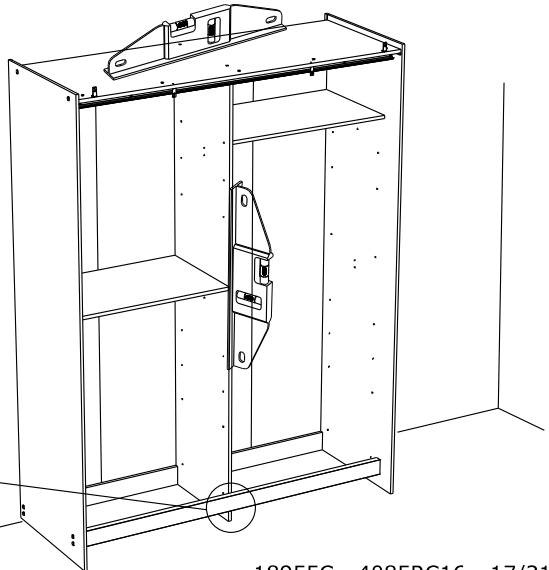
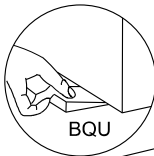

- FR** Pour votre sécurité : Fixation du meuble au mur  
Attention, la fixation doit être réalisée par une personne compétente car cela nécessite des chevilles adaptées à la nature de votre mur.
- EN** For your safety: the unit should be secured to the wall.  
NB this should be carried out by a competent person as you must use the right rawlplug for your type of wall.
- DE** Zu Ihrer Sicherheit: Befestigen Sie das Hochbett an der Wand.  
Achtung: Diese Befestigung ist durch eine fachlich kompetente Person vorzunehmen. Hierfür sind für die Bauweise Ihrer Wand geeignete Dübel einzusetzen.
- ES** Por su seguridad: Fijar el mueble a la pared.  
Advertencia: la fijación la ha de llevar a cabo por personal adecuado, ya que requiere el uso de tacos que se adapten al tipo de pared.
- PT** Para sua segurança: fixação do móvel ao muro  
Atenção: a fixação deverá ser efetuada por pessoa habilitada, visto que são necessárias cavilhas adaptadas ao tipo de parede.
- IT** Avvertenza di sicurezza: il fissaggio del mobile a parete deve essere realizzato da una persona competente, in quanto l'operazione richiede l'impiego di tasselli adatti alla natura del muro.
- NL** Voor uw veiligheid: bevestiging van het meubel aan de muur.  
Opgelet de bevestiging moet worden uitgevoerd door een bekwame persoon daar dit voor uw type muur geschikte pluggen vereist.
- CZ** Z bezpečnostních důvodů: upevněte nábytek do zdi  
Pozor, upevnění je třeba svěřit kompetentní osobě, neboť vyžaduje hmoždinky vhodné pro vaši zed.
- HU** Az Ön biztonsága érdekében : a bútor falra rögzítése  
Figyelmeztetés : a rögzítés csak megfelelő szakképesítéssel rendelkező személy által végezhető el, mert a rögzítéshez a falnak megfelelő csavarokra van szükség.
- PL** Dla bezpieczeństwa: mocowanie mebla do ściany  
Uwaga, mocowanie musi zostać wykonane przez osobę kompetentną, ponieważ wymaga to zastosowania kolków dostosowanych do rodzaju ściany.
- RO** Pentru securitatea dumneavoastră: fixarea mobilierului de perete  
Atenție, fixarea trebuie să fie realizată de o persoană calificată, deoarece sunt necesare dispozitive de fixare adaptate caracteristicilor peretelui dumneavoastră
- RU** Для вашей безопасности: Крепление мебели к стене  
Внимание! Крепление должно производиться опытным специалистом, т.к. для такой установки потребуются штифты, соответствующие типу вашей стены.
- SK** Z bezpečnostných dôvodov: nábytok upevnite k stene.  
Dbajte na to, aby upevnenie vykonala kompetentná osoba, pretože pri upevňovaní sa vyžadujú kolíky vhodné do materiálu, z ktorého je stena vyrobená.
- TR** Güvenliğiniz için: Mobilyanın duvara sabitlemesi  
Dikkat, sabitleme işlemi uzman biri tarafından yapılmalıdır çünkü bu işlem için duvarınızın malzemesine uygun dübellerin kullanılması gerekmektedir
- GR** Για την ασφάλειά σας : στερέωση των επίπλων στον τοίχο.  
Προσοχή, η στερέωση πρέπει να γίνεται από ικανό άτομο, καθώς απαιτούνται σφηνές προσαρμοσμένες στη φύση του τοίχου σας.

#### اللغة العربية

لسلامتكم الشخصية: تثبيت قطعة الأثاث على الحائط  
تحذير، يجب أن يقوم شخص متخصص بعملية التثبيت على الحائط إذ أنها تتطلب أسفينا  
معينا يتوافق مع طبيعة الحائط نفسه.

- ZH** 为了您的安全：本产品必须靠墙安装。  
NB 本产品必须由专业人士安装，且您必须使用符合您的墙壁类型的罗威纤维管。

21

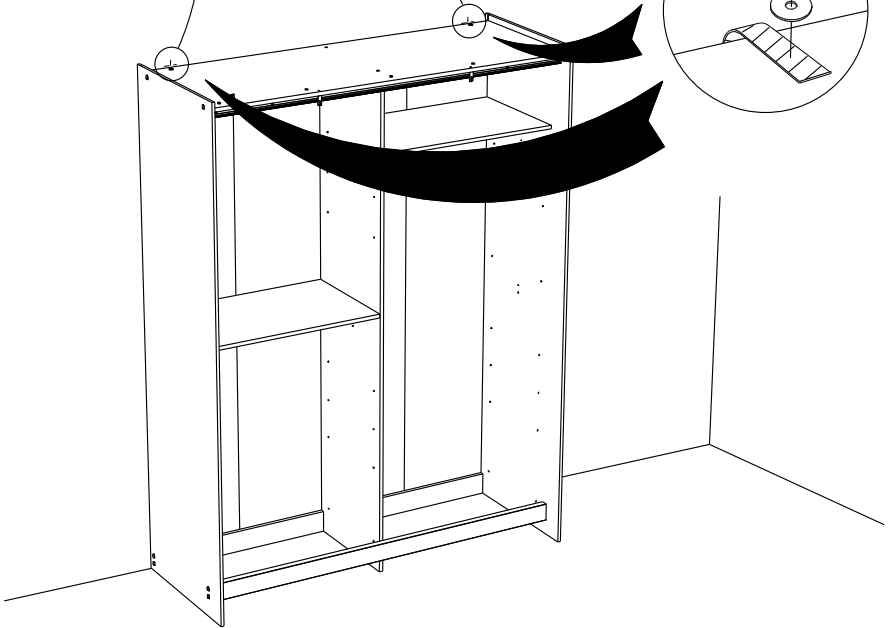
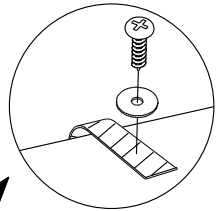
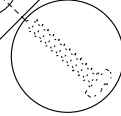
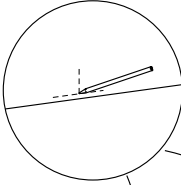
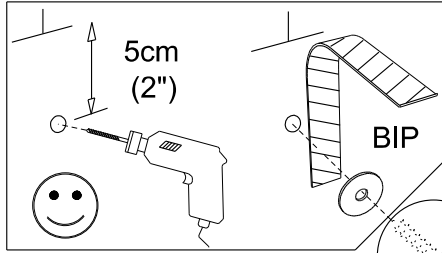
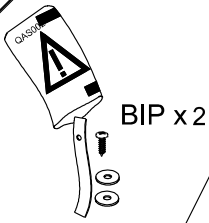

22

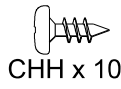
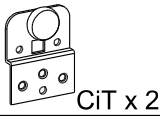

1°

2°

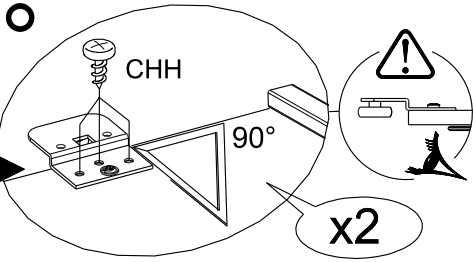
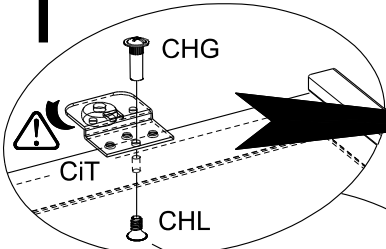

x2

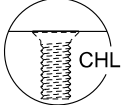

10

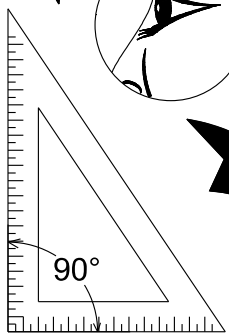

90°



x2

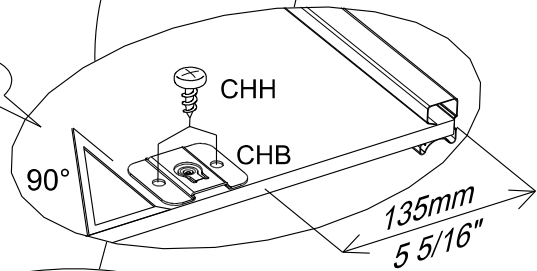

90°

135mm  
5 5/16"

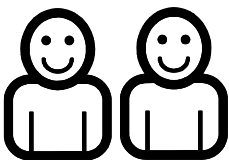
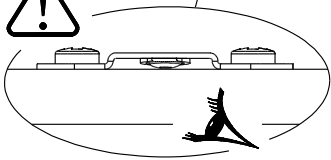

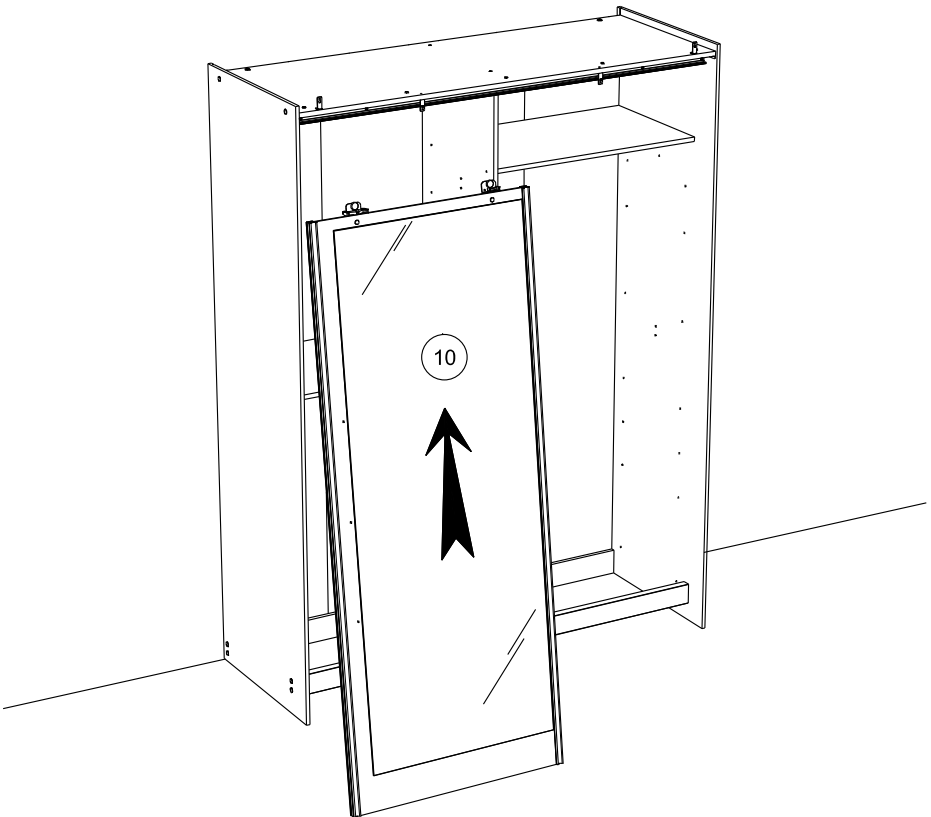
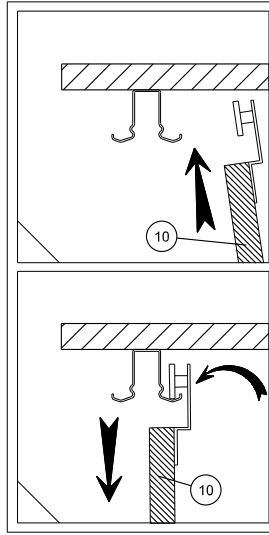
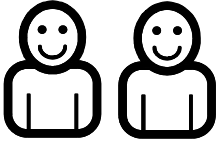

24



CHB x 2

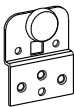

CiT x 2

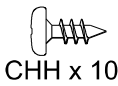

CHH x 10



CHG x 2



CHL x 2

1°

2°

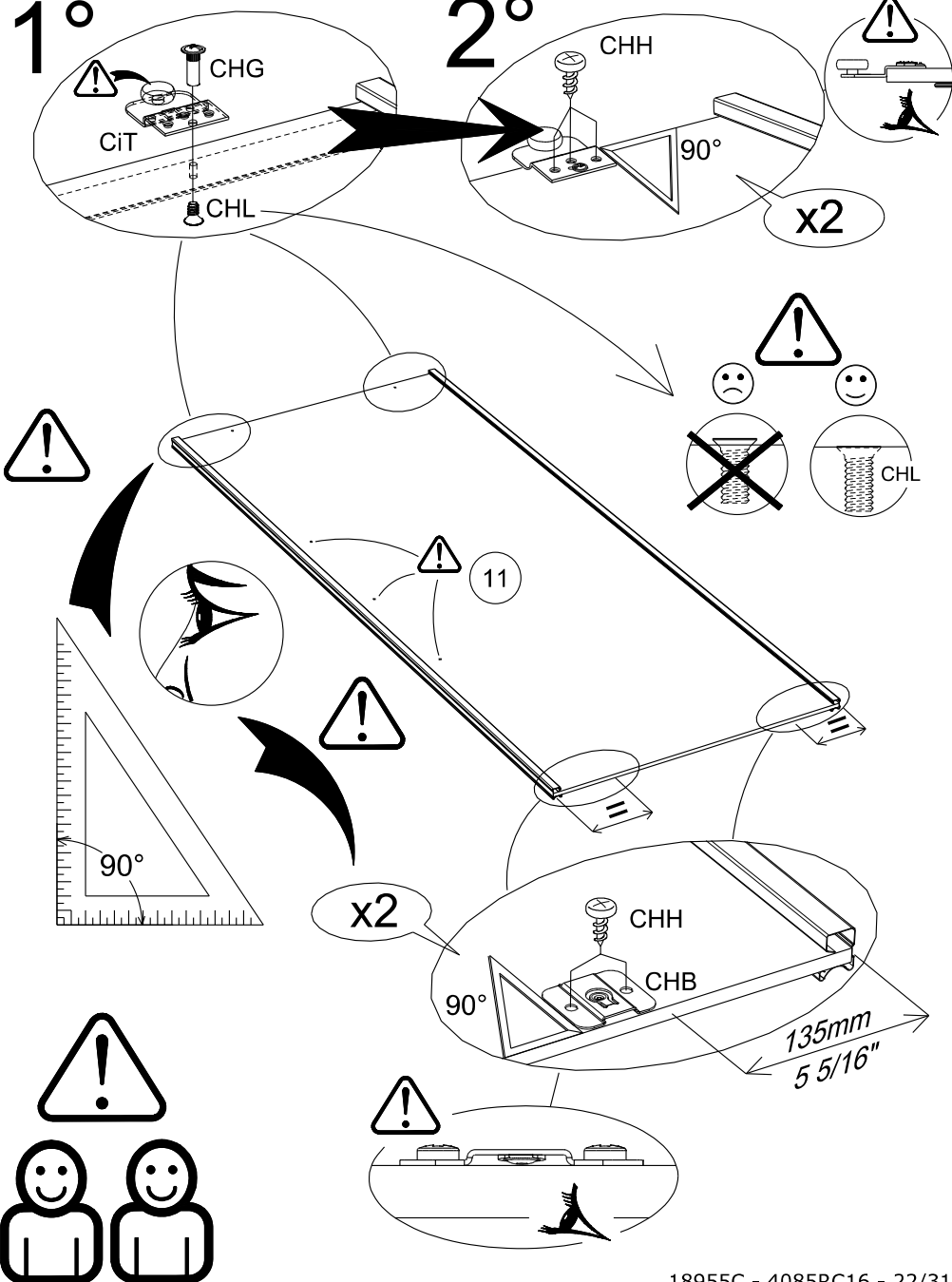

25

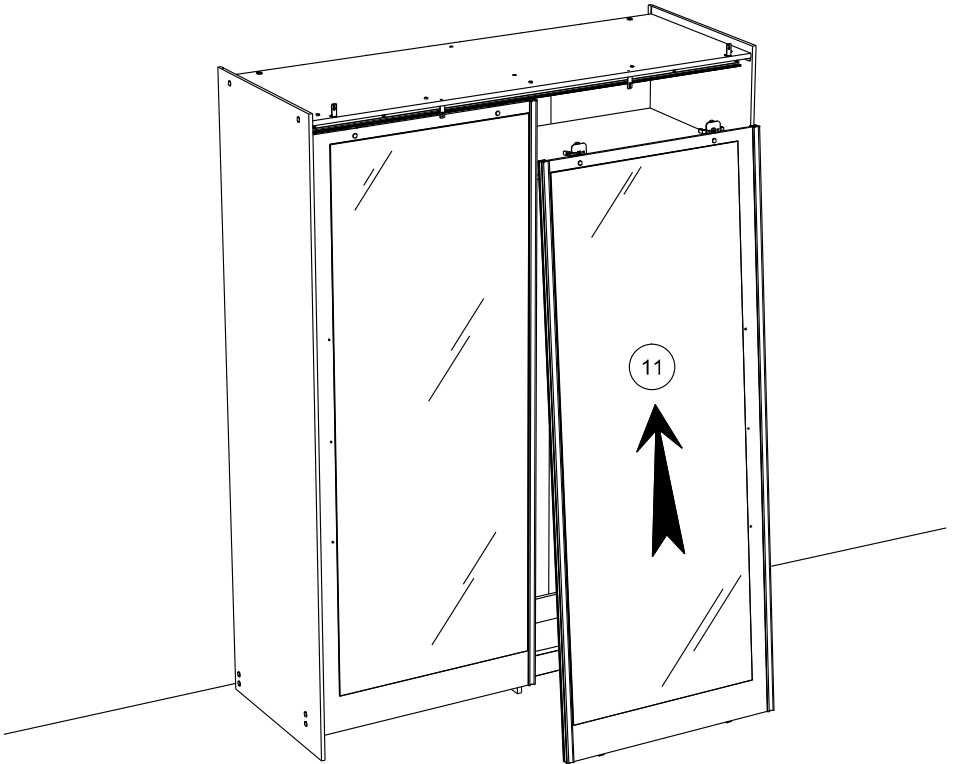
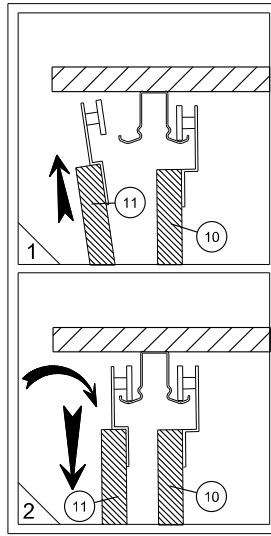
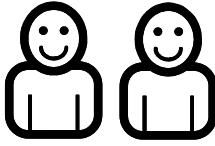

26

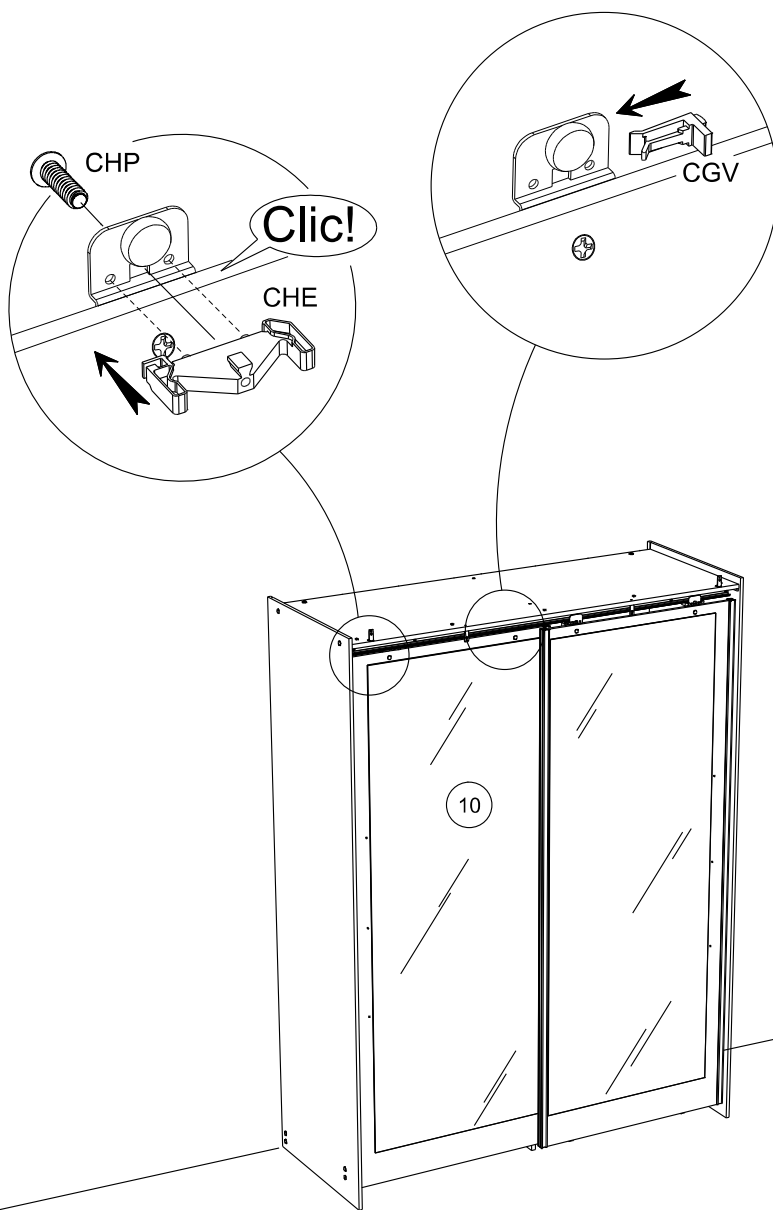
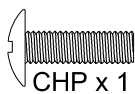
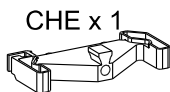



27

CGW x 1

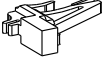

CHE x 1

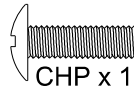
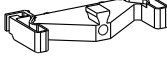

CHP x 1

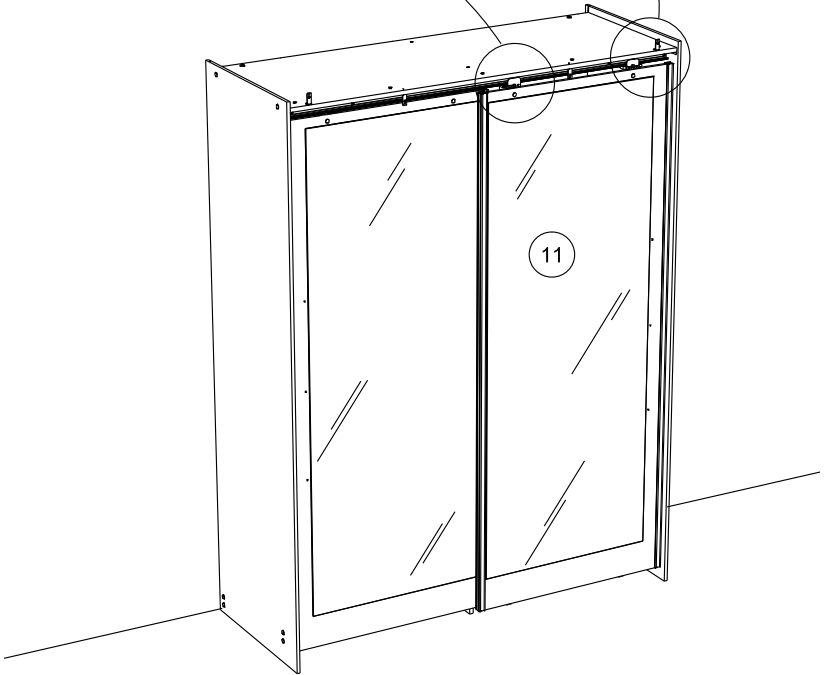
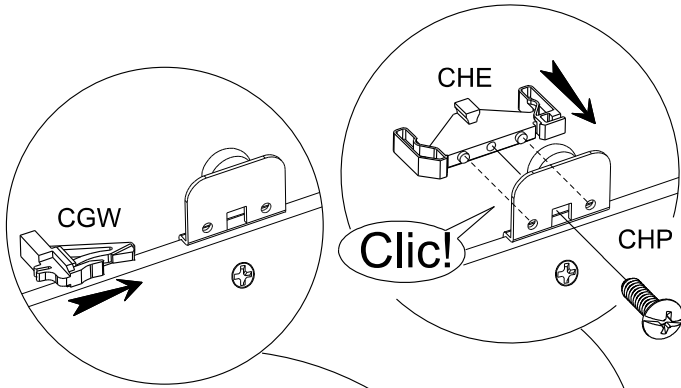

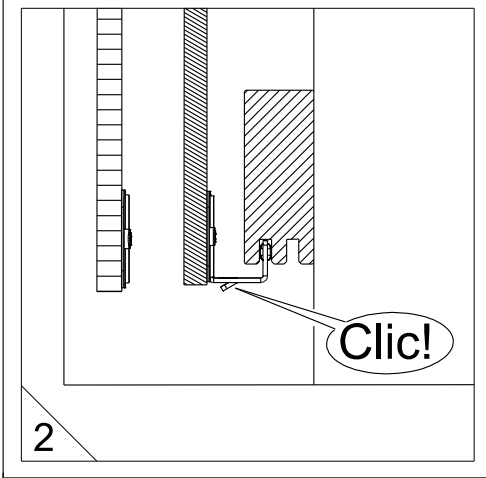
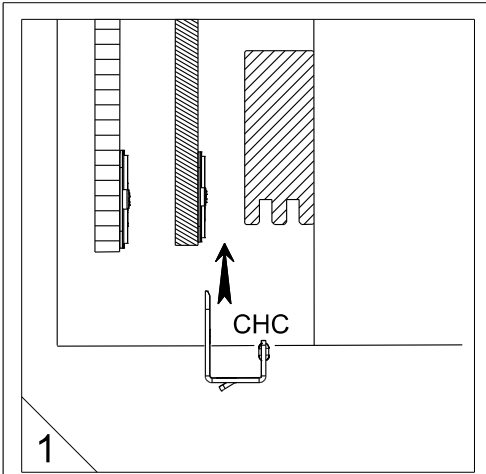
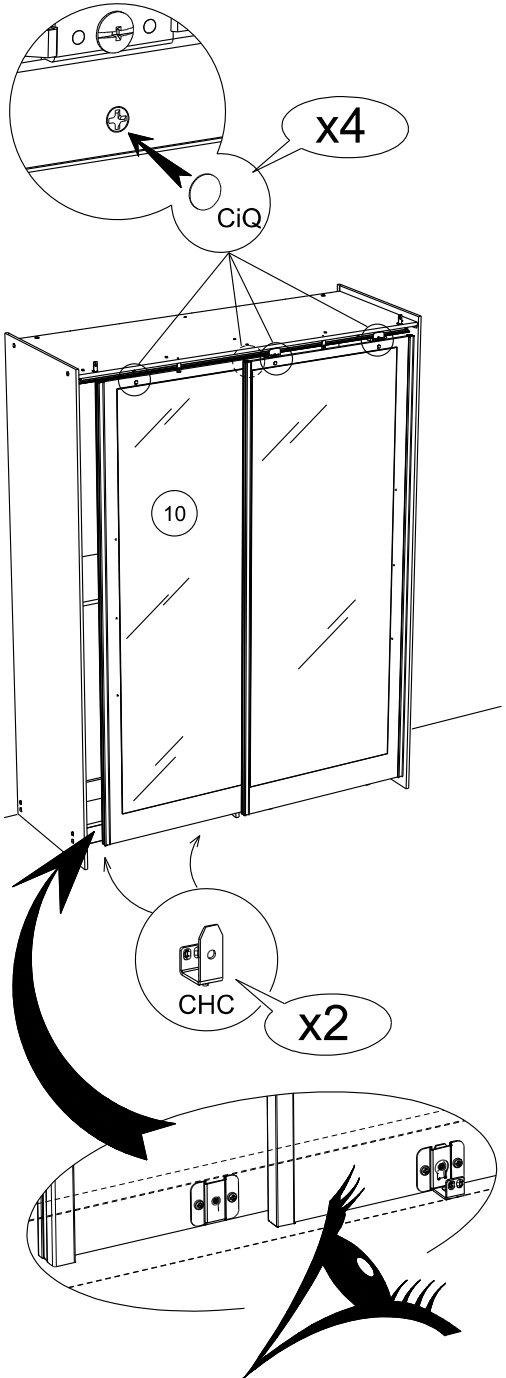
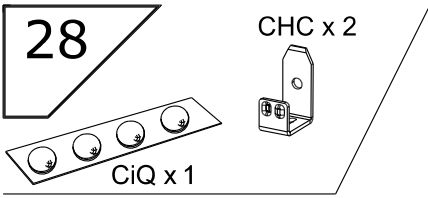

29

CiU x 2

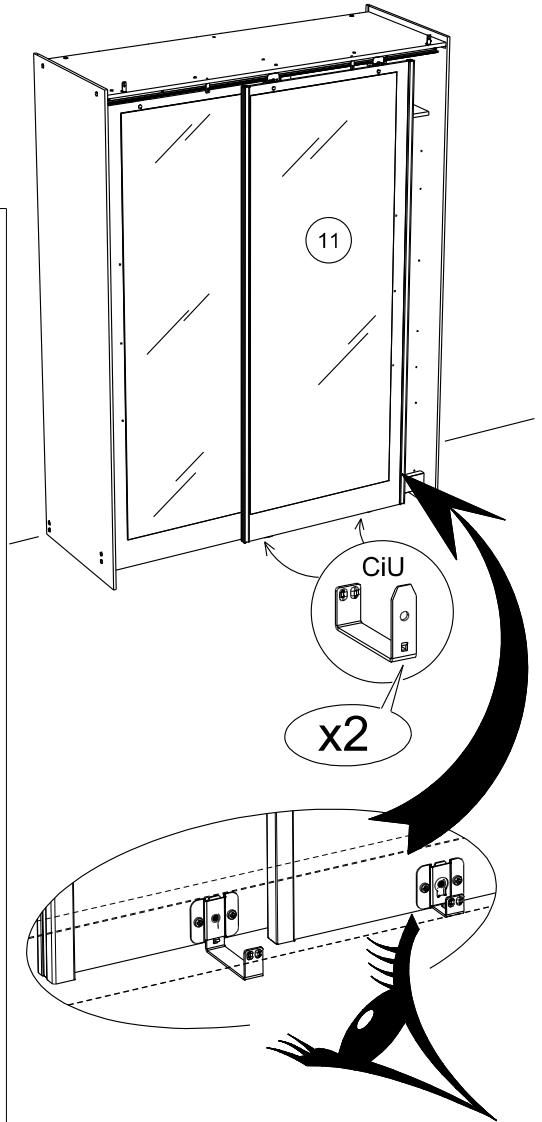
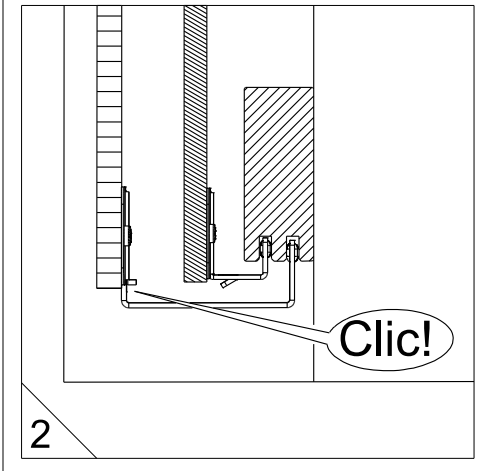
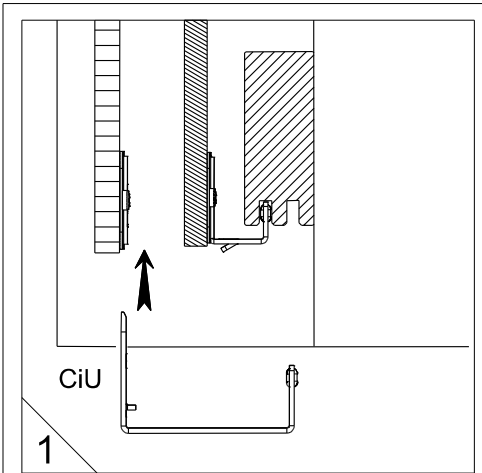

30

CF x 2

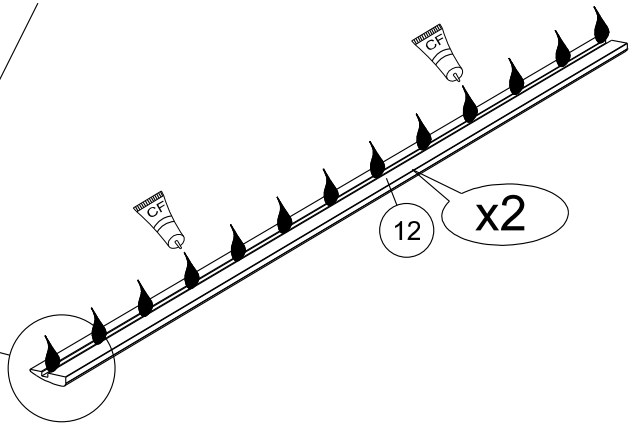
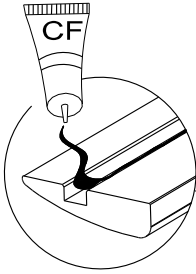

31

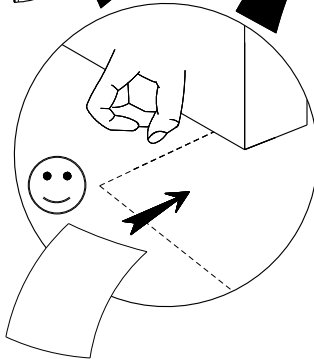
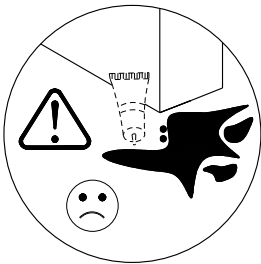
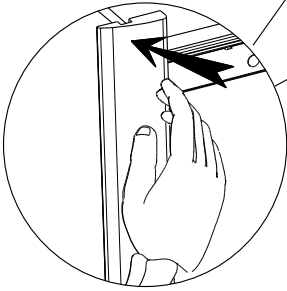
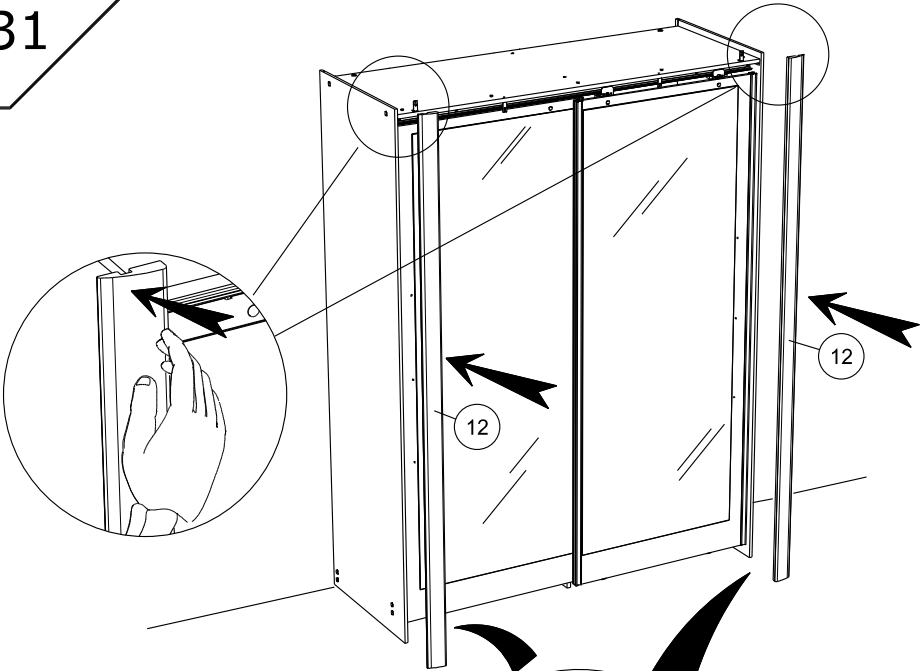

32

ABB x 6

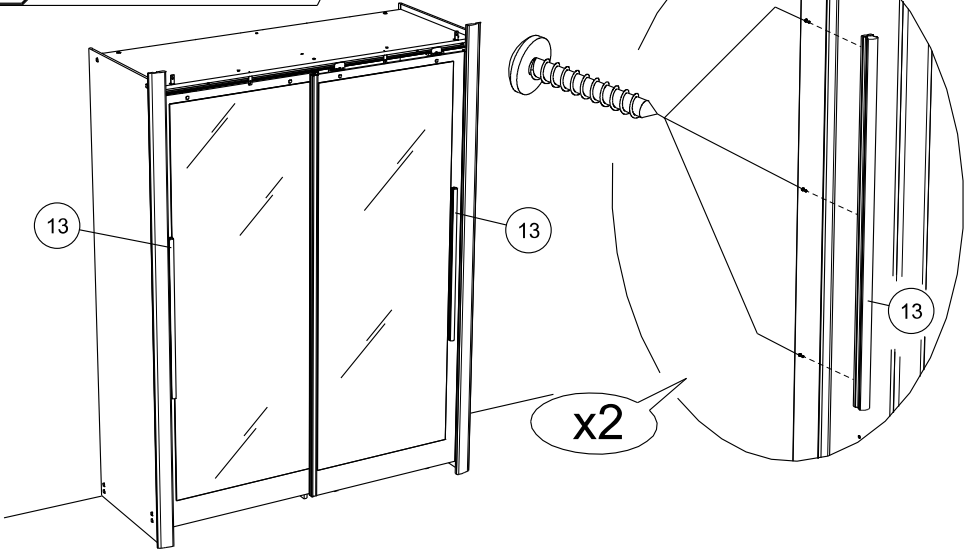

33

CHH x 2

CiO x 2

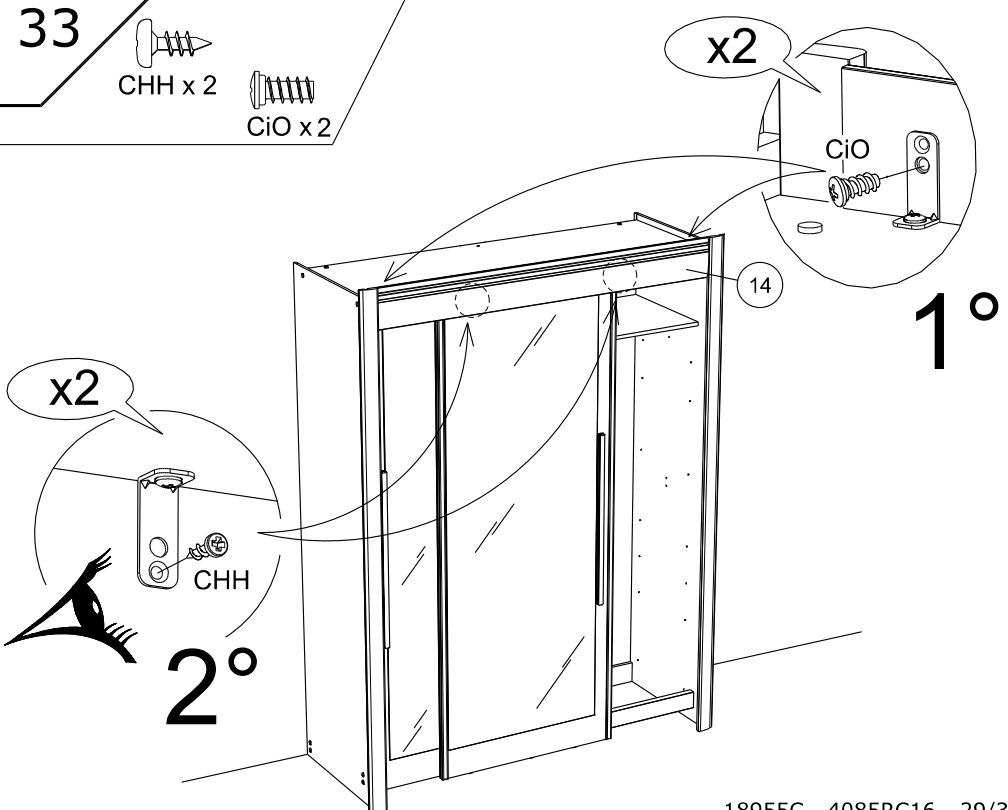

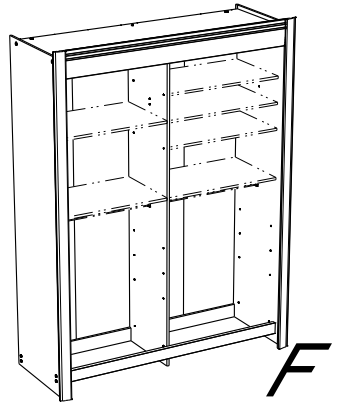
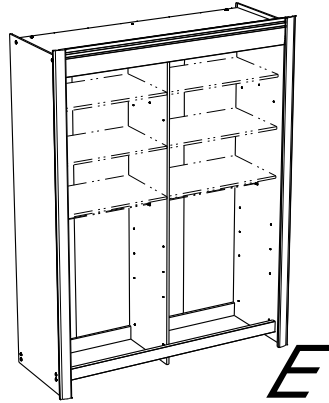
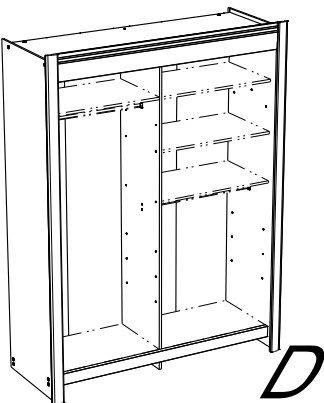
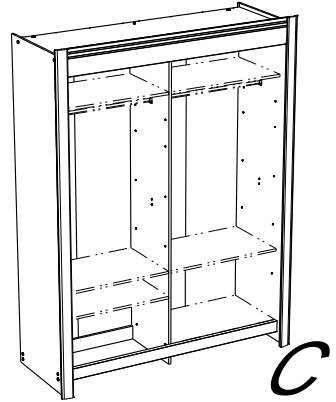
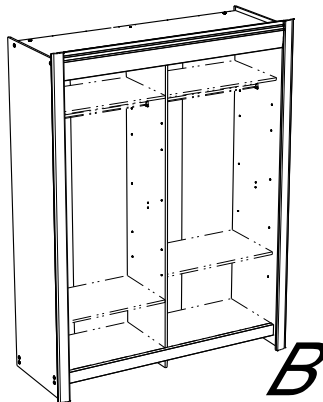
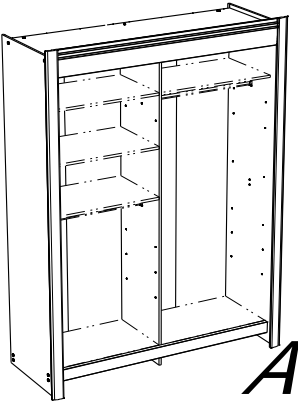
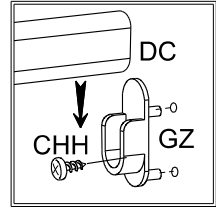
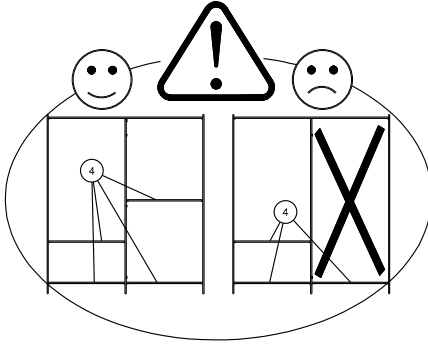
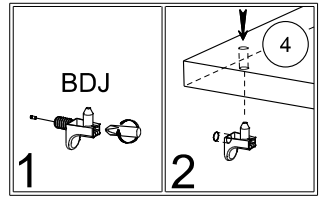
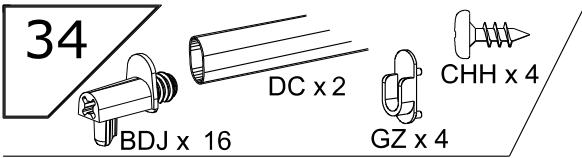

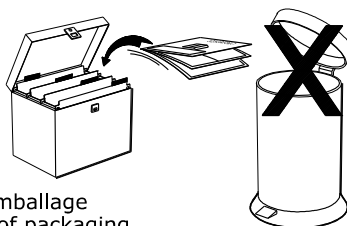
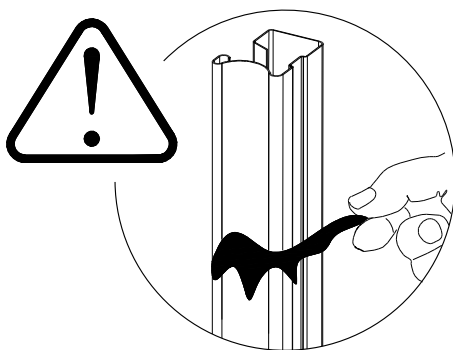
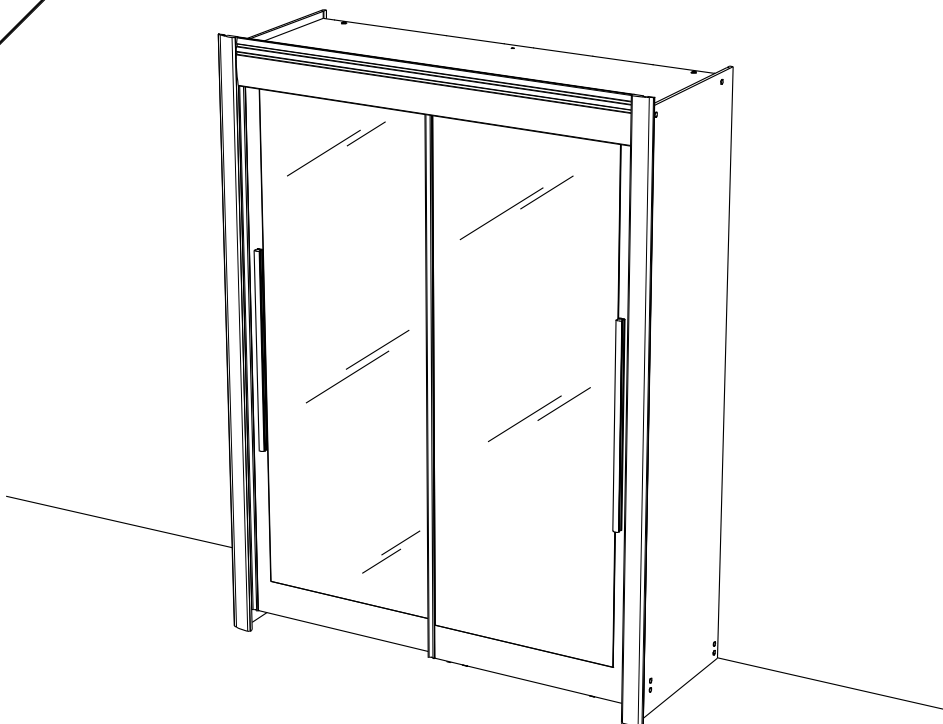

Faites un geste pour l'environnement en triant vos déchets d'emballage  
Make a gesture for the environment by sorting out your waste of packaging  
Machen Sie eine Bewegung für die Umwelt, ihre Verpackungsabfälle sortierend  
Haga un gesto para el medio ambiente escogiendo sus residuos de embalaje