

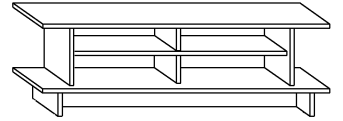

KANSAS

→ 110 ↑ 36 ↘ 35



x 7

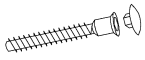

a

x 7



b

x 2

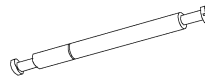

c

x 16

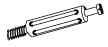

d

x 20



e

x 5



f

x 1

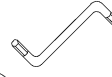

g

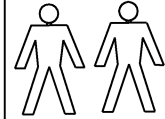

40 min

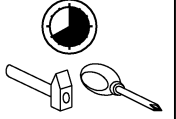

1 - FAZY MONTAŻU

A - OZNACZENIE ELEMENTÓW

a - OZNACZENIE AKCESORIÓW

1

x 5



b

x 10



d

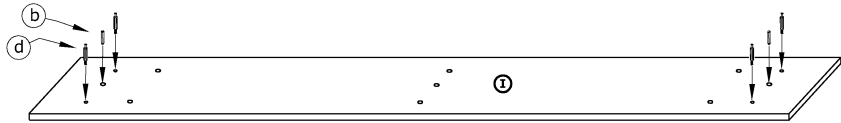
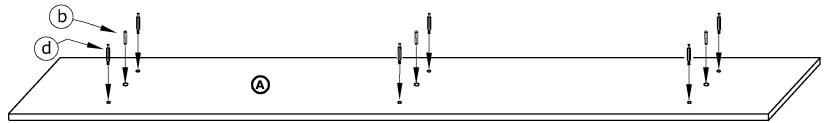

2

x 2



b

x 6



d

x 4



f

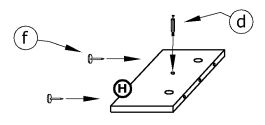
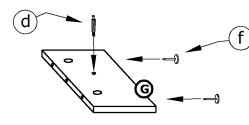
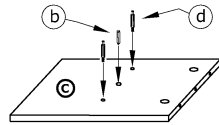
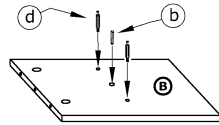

3

x 2



e

x 1



f

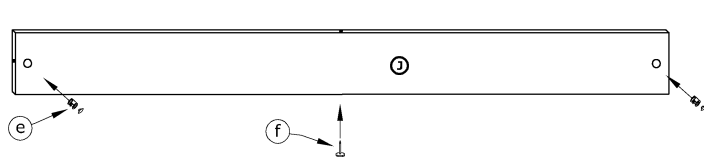
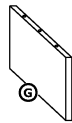

4

x 1



a

x 4



e

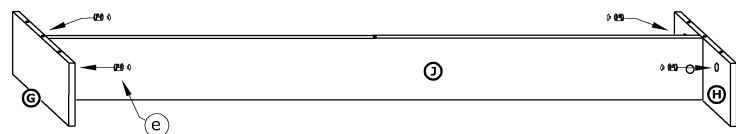
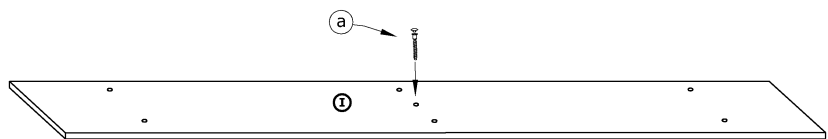

- 5** x 2 x 8
- (c) (e)

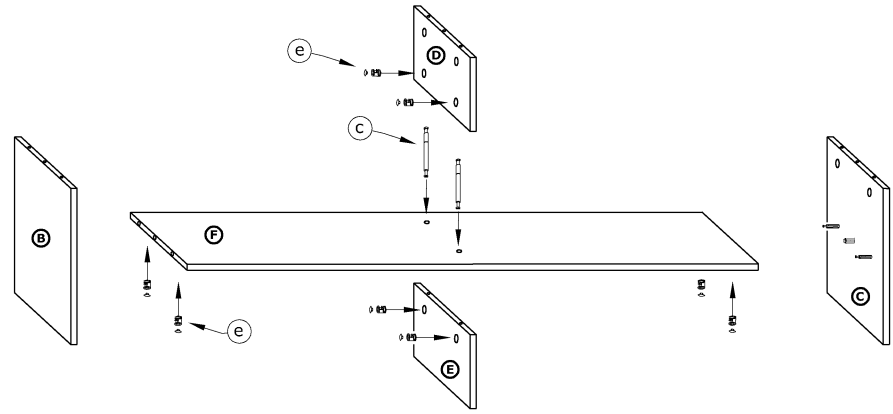

- 6** x 6
- (e)

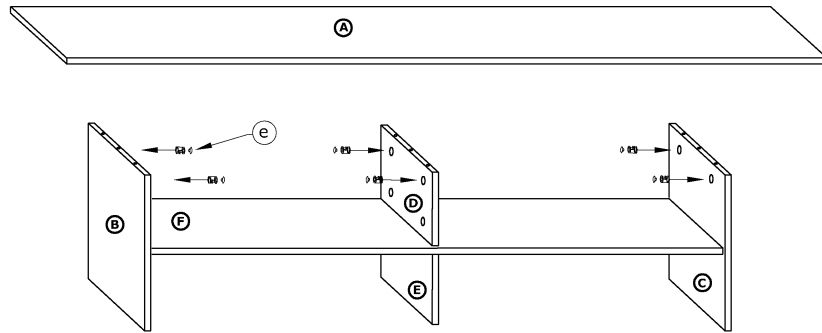

- 7** x 6
- (a)

