









LIST OF ACCESSORIES CT-6027

A		C		E		G		I			
	1Pcs		3Pcs		4Pcs		4Pcs		4Pcs		
B		D		F		H					
	4Pcs		2Pcs		12Pcs		4Pcs				

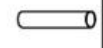
ASSEMBLING STEPS

①

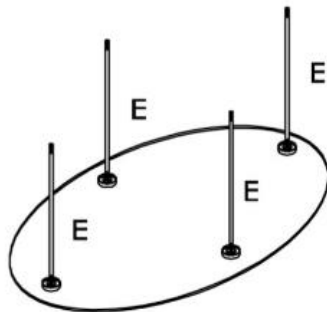

②

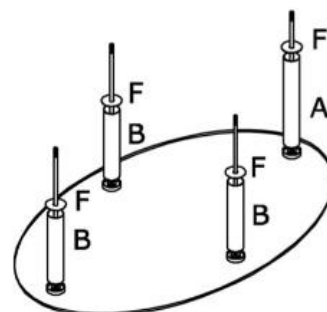

③

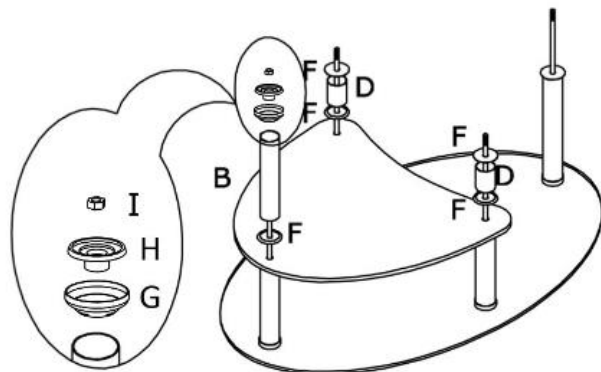

④

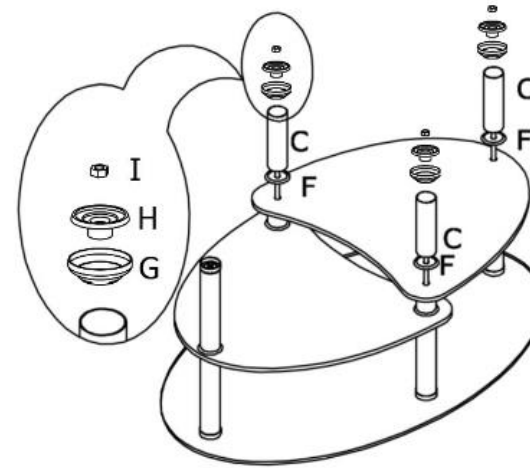

⑤ TOLEDO

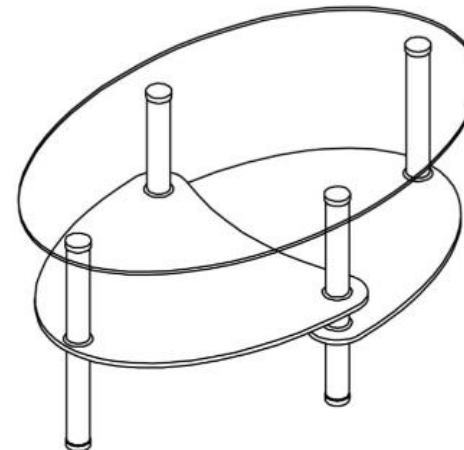

POLDIMAR B.V.B.A