













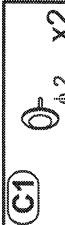









1	 x28	 x16	 x16	 ϕ 8x28 x18	 7x50 x4	 ϕ 2 x2	 4.2x12 x22	 x22	 ϕ 15 x16	 ϕ 10 x6	 x16	 x1
---	---	---	---	---	---	---	--	---	---	--	---	--



2	 x2	 3.0x13 x2
---	--	---





3	 x1	 6.3x11 x5	 x1
---	--	---	--



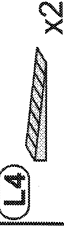

4	 x1	 6.3x11 x5
---	---	--

5	 x2	 6.3x11 x10
---	--	--

6	 x2	 6.3x11 x4
---	--	---

7	 x2	 6.3x11 x4
---	--	---

8	 x2	 3.5x13 x7	 3.0x13x76	 x2
---	--	---	--	--

9	 x2	 3.5x13 mm x4	 x2	 x2
---	--	--	---	--

 L=1062 mm x1
--

 L=1974 mm x1
--

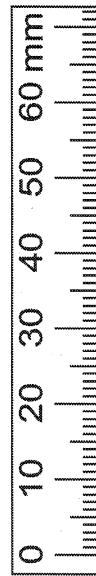

1

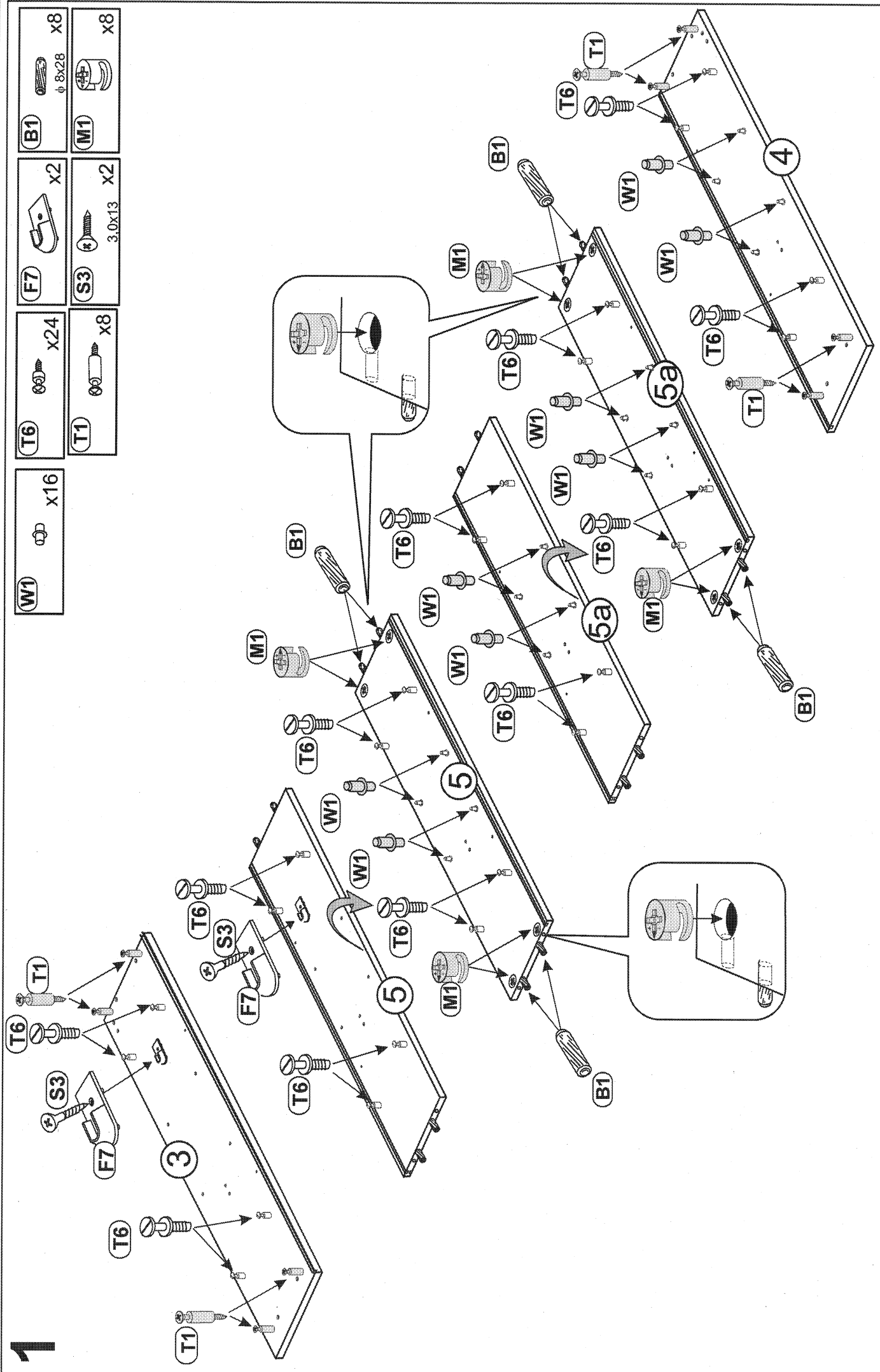

(W1)	x16
------	-----

(T6)	x24
------	-----

(F7)	x2
------	----





(B1)	x8
------	----

(T1)	x8
------	----

(S3)	3.0x13
------	--------

(M1)	x8
------	----

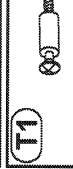
2

	x8
	x1
	x8
	x10
	x4

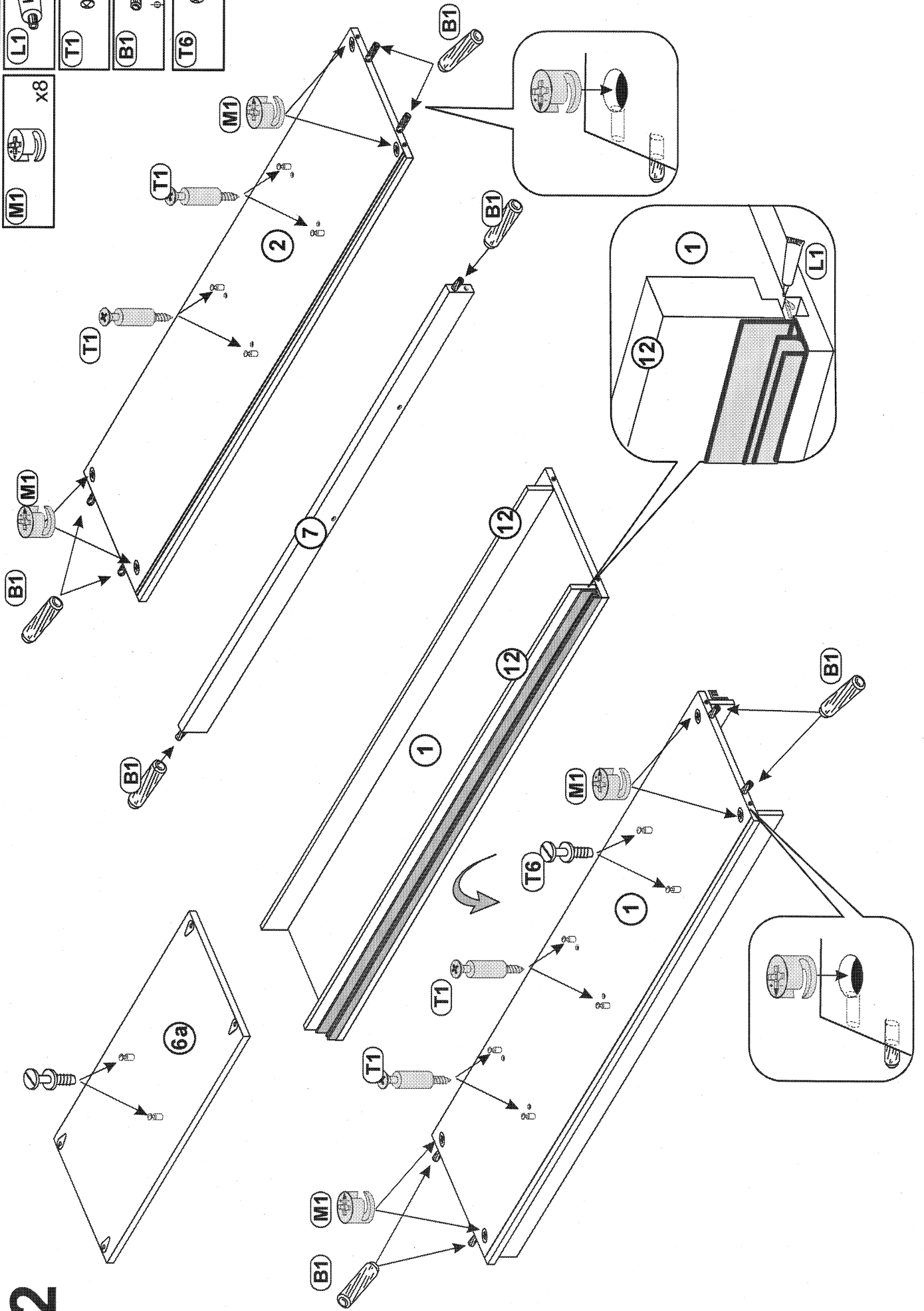

3

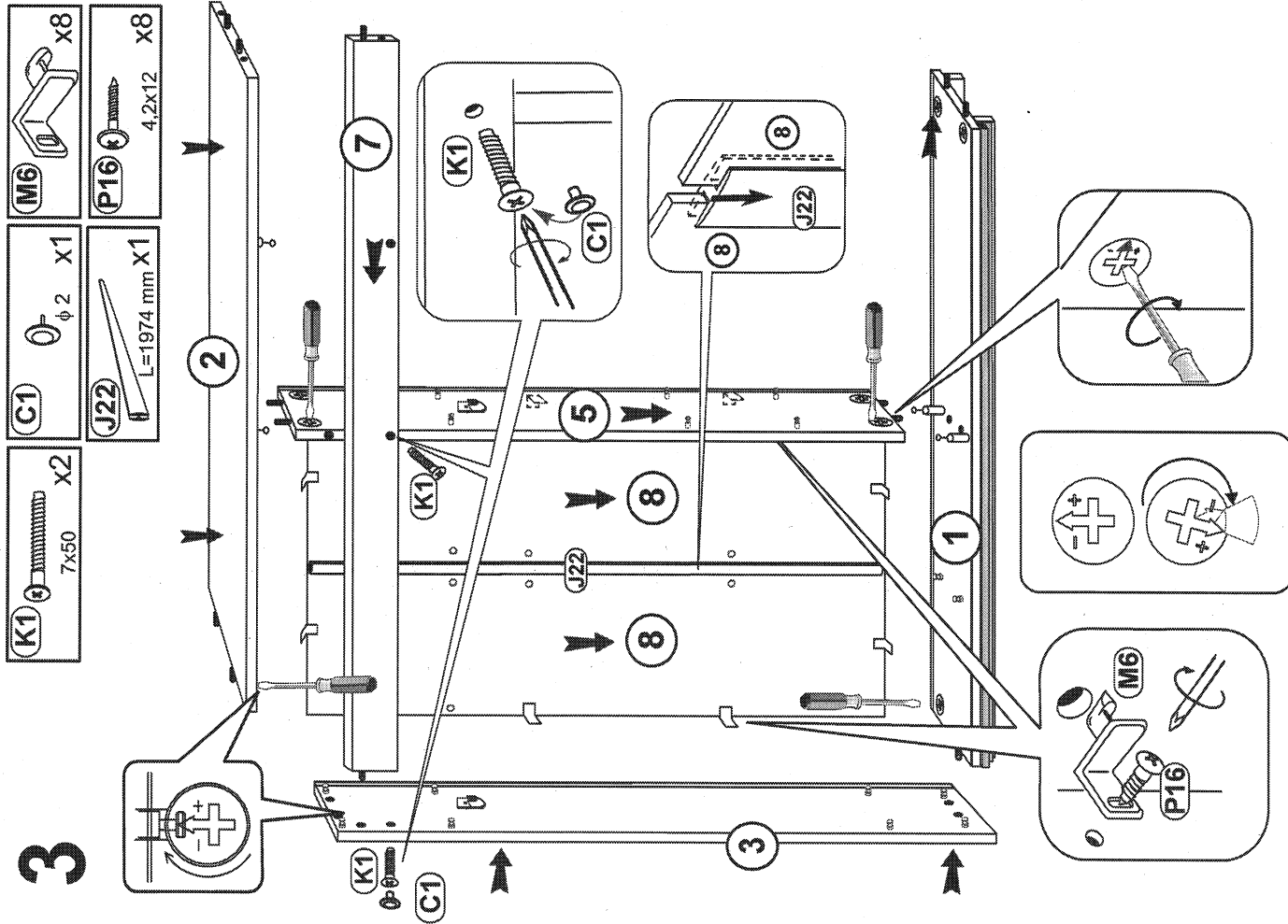

4

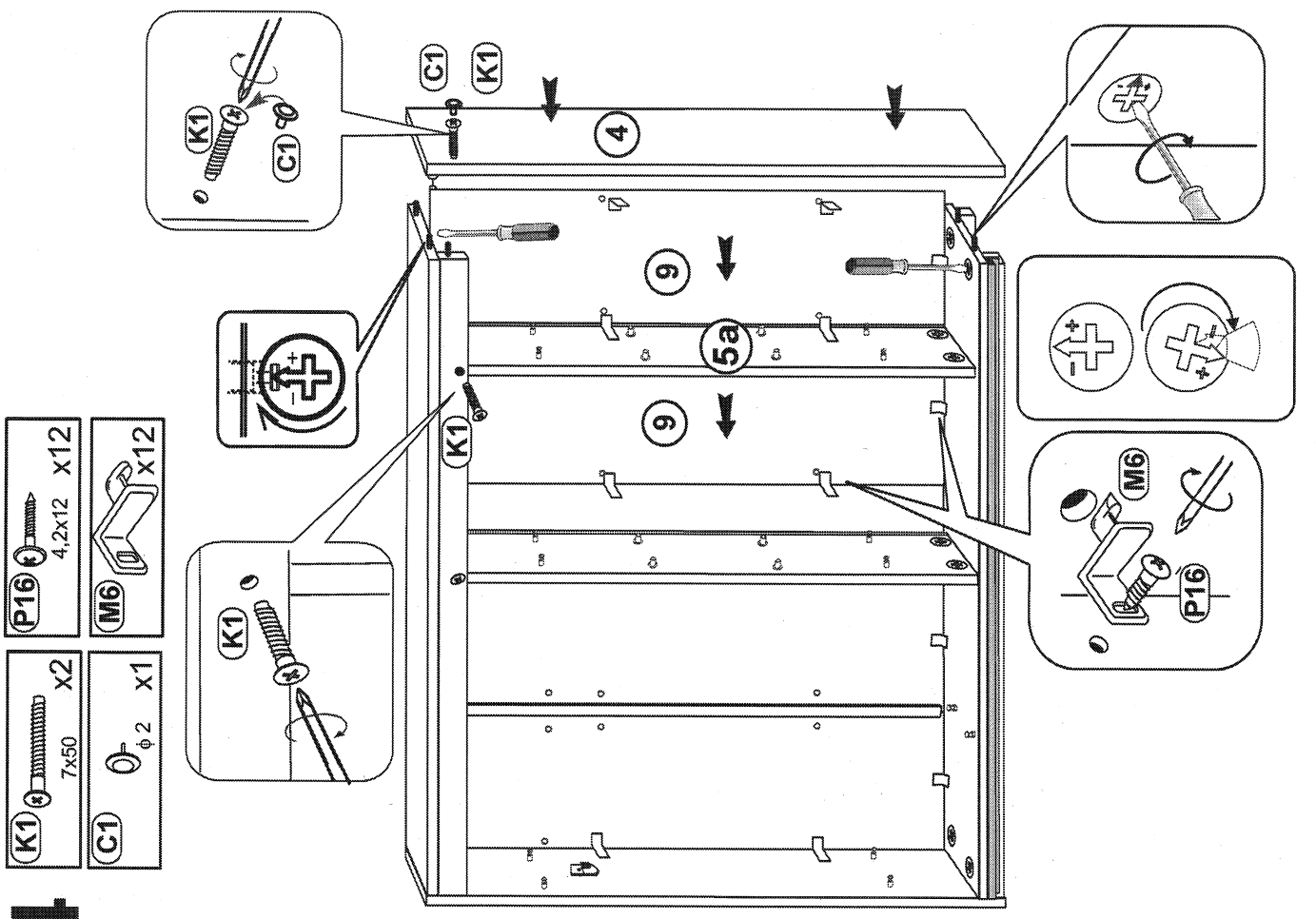

5

- (P16)** 4,2x12 x2
- (M6)** x2

- (J20)** L=1062 mm X1

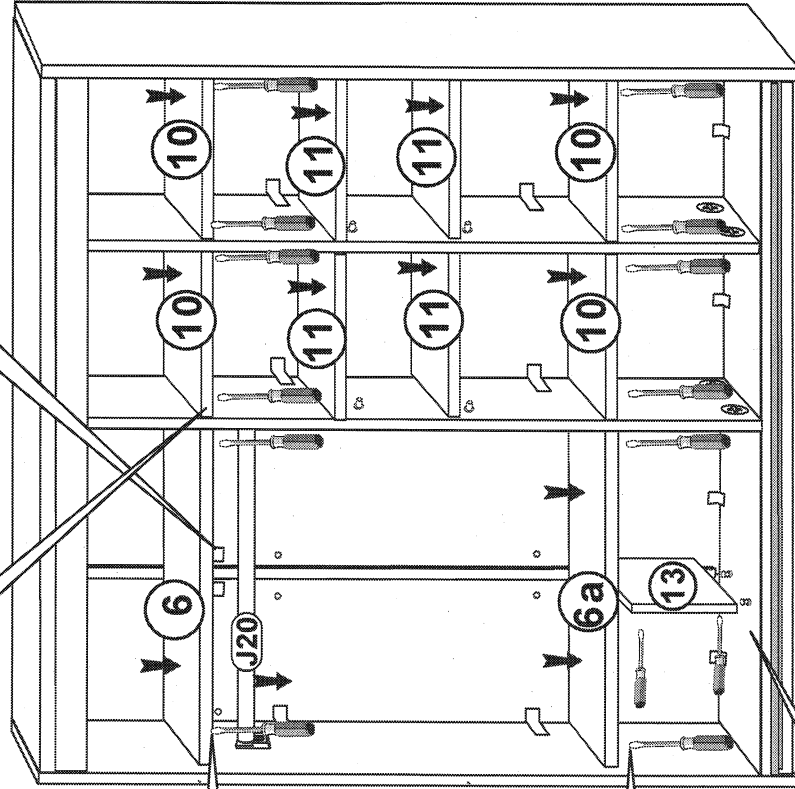
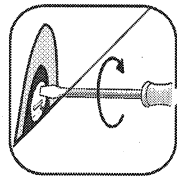
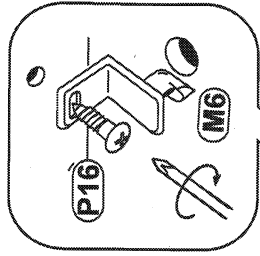

6

- (S4)** 3,5x13 x7
- (C2)** Ø15 x16
- (C3)** Ø10 x6

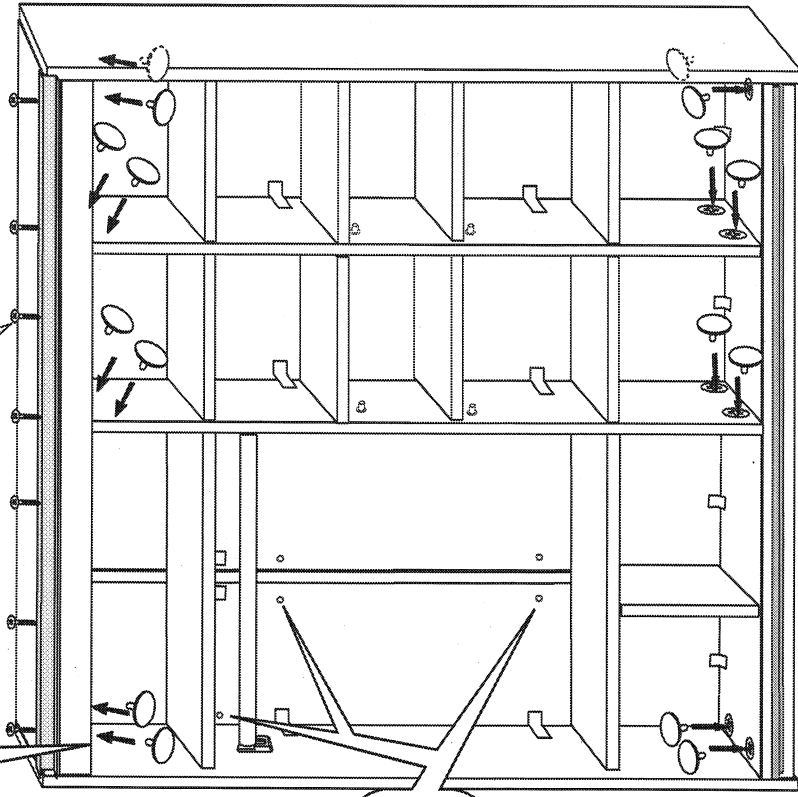
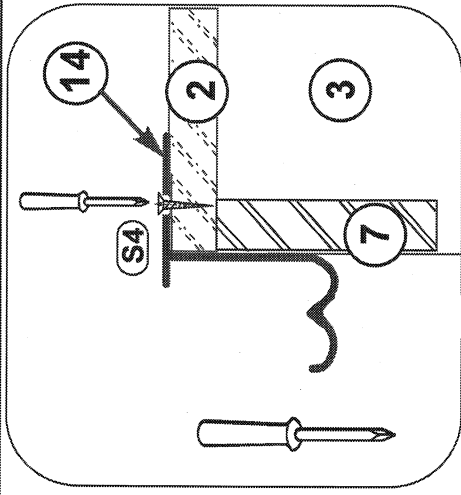
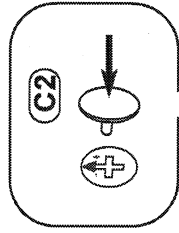

7

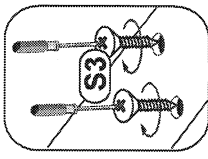
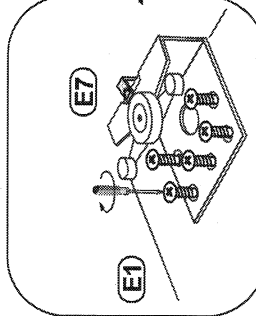
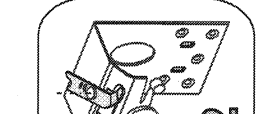
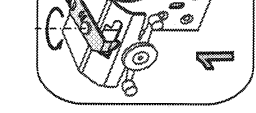
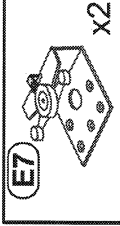
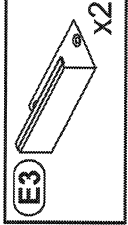
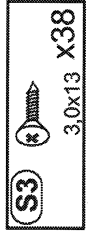
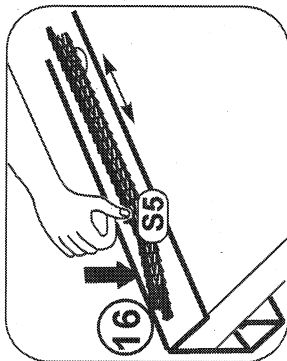

17

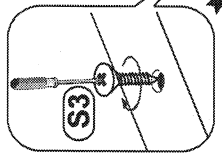

S5

16

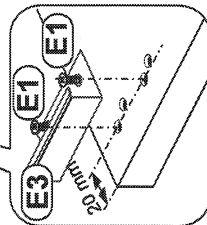

E3

21

20



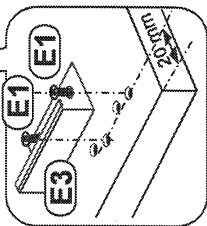
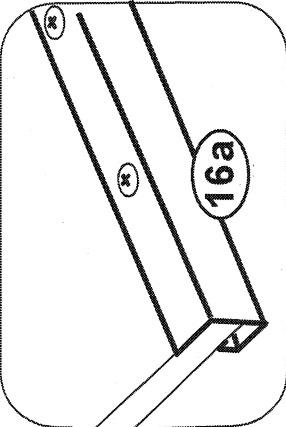

16a

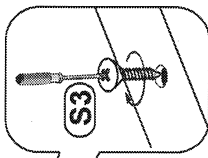

E3

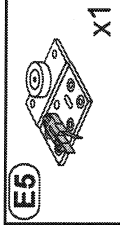
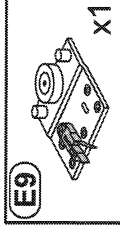
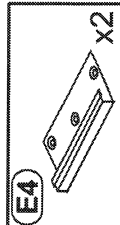

16a

-  S3 3.0x13 X38
-  E5 X1
-  E9 X1
-  E4 X2
-  E1 X14
-  E11 X1
-  E1 X1
-  S5 X1

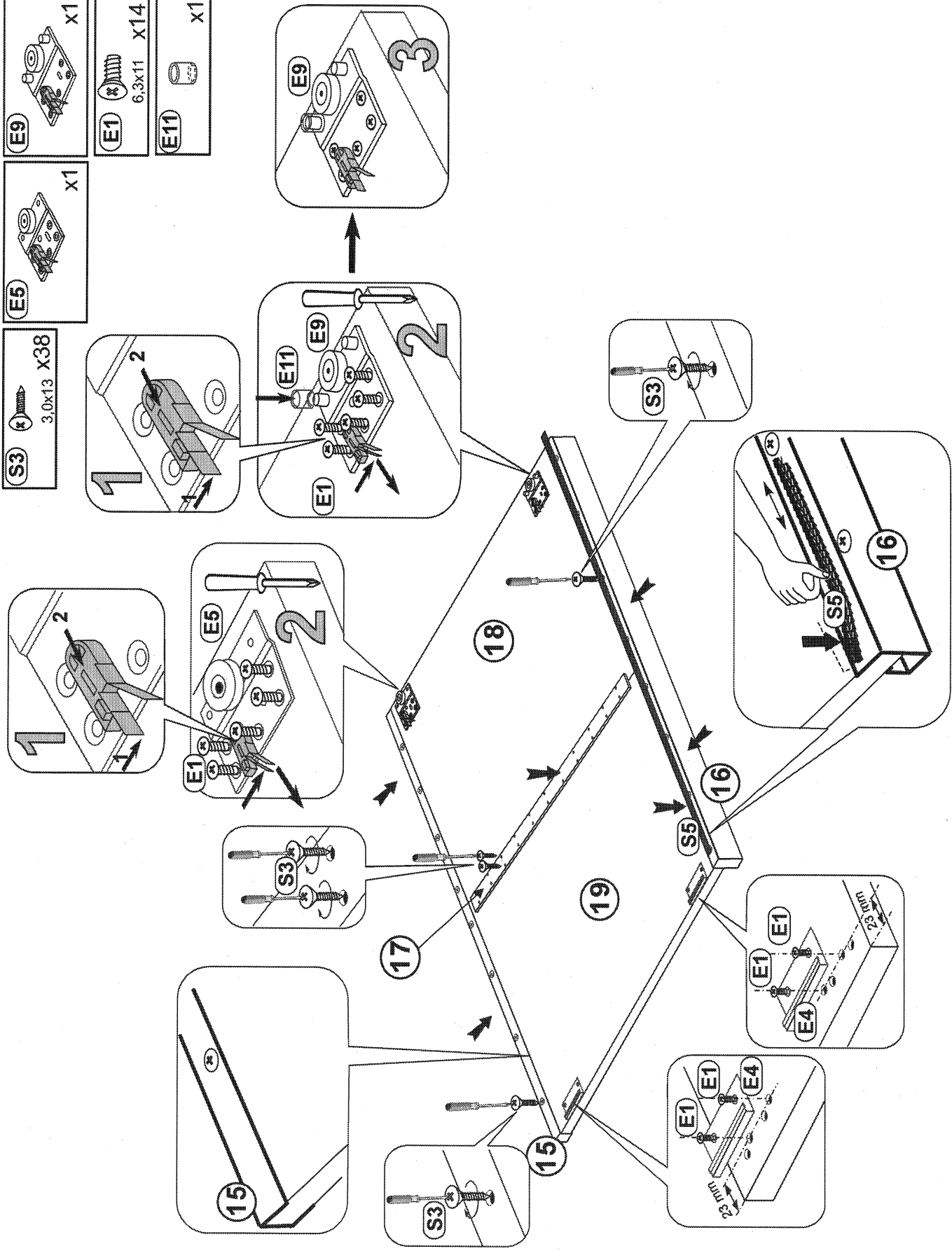

9

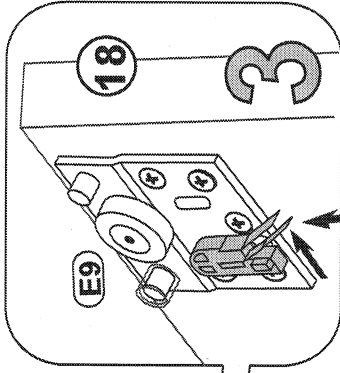
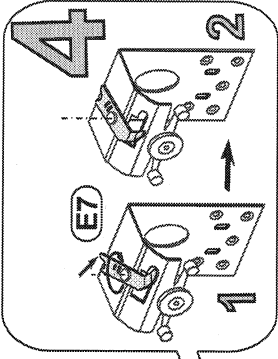
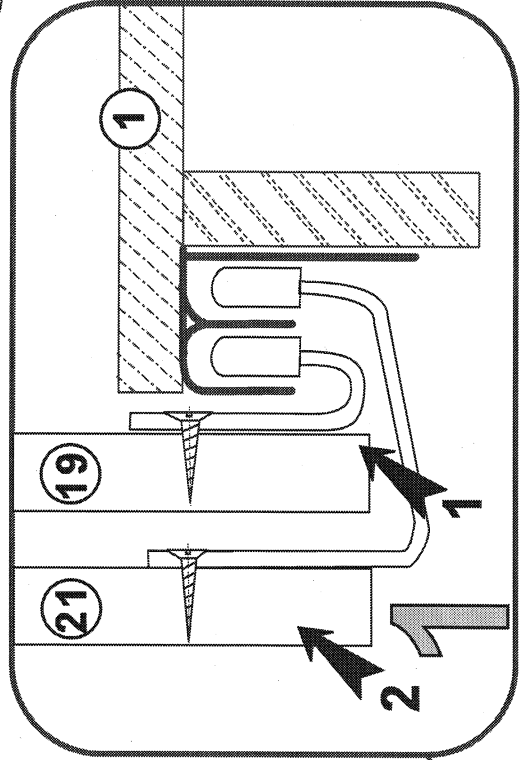
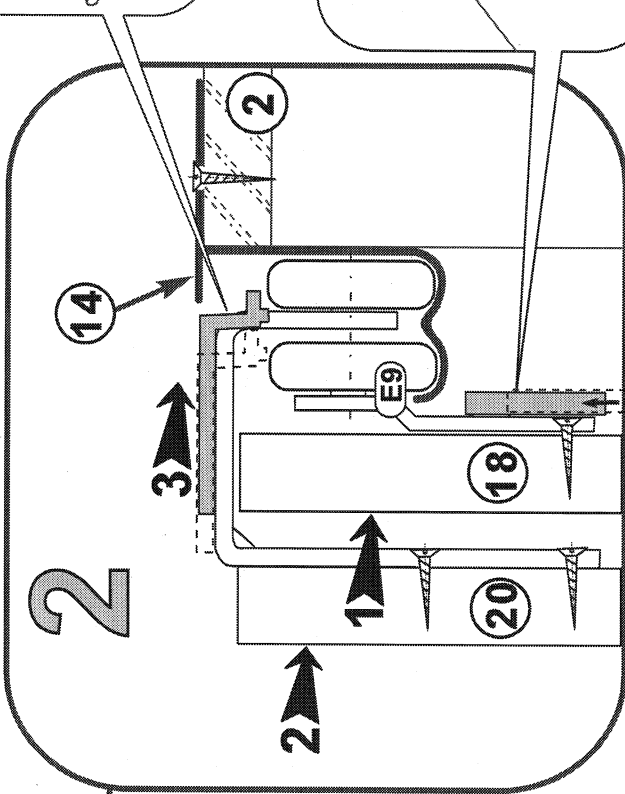
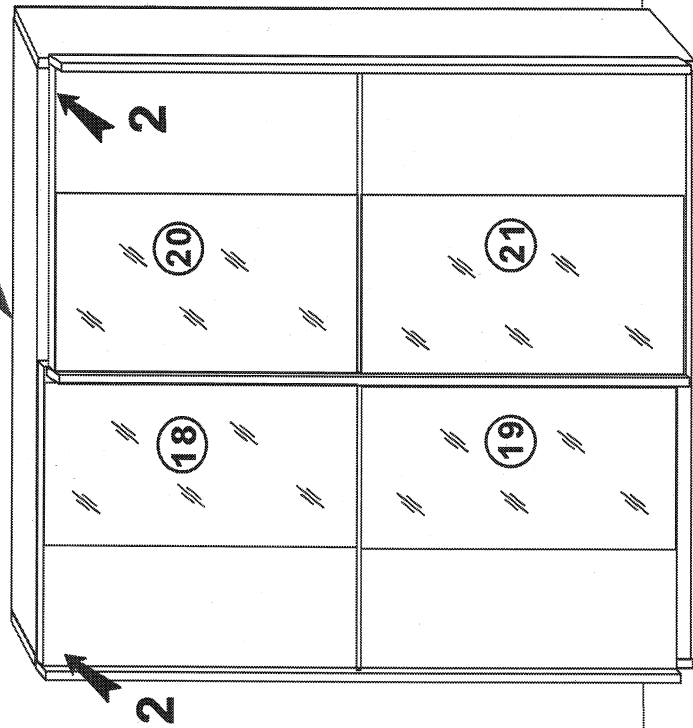

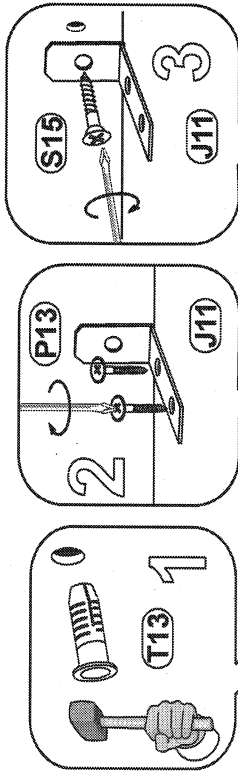

PL Złączone kolki do zawieszania bryły, do stosowania wyłącznie do ścian betonowych, do innych ścian należy odpowiednio dokupić.

GB Attached dowels to hang up unit are for concrete walls only. For other types of walls, appropriate dowels must be purchased.

D Die beigefügten Dübel zum Aufhängen des Elements dürfen nur bei Betonwänden eingesetzt werden, bei anderen Wandarten müssen entsprechende Dübel zugekauft werden.

F Les chevilles jointes, pour pendre l'élément, sont pour les murs bétonnés exclusivement; pour autres murs il faut acheter chevilles adéquates.

