













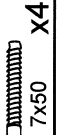
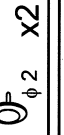
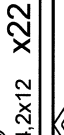
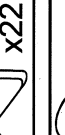

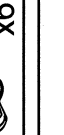
<b>1</b>	<b>(T6)</b>  x28	<b>(M1)</b>  x16	<b>(T1)</b>  x16	<b>(B1)</b>  $\phi$ 8x28 x18	<b>(K1)</b>  7x50 x4	<b>(C1)</b>  $\phi$ 2 x2	<b>(P16)</b>  4,2x12 x22	<b>(M6)</b>  x22	<b>(C2)</b> $\phi$ 15  x16	<b>(C3)</b> $\phi$ 10  x6	<b>(W1)</b>  x16	<b>(L1)</b>  x1
----------	--	--	--	--	--	--	--	---	---	--	--	---

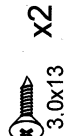
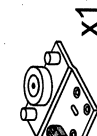
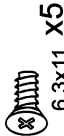

<b>2</b>	<b>(F7)</b>  x2	<b>(S3)</b>  3,0x13 x2
----------	---	--

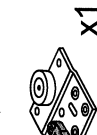
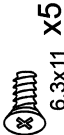
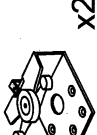

<b>3</b>	<b>(E9)</b>  x1	<b>(E1)</b>  6,3x11 x5	<b>(E11)</b>  x1
----------	---	--	--

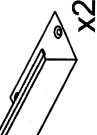
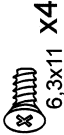

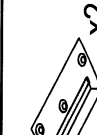
<b>4</b>	<b>(E5)</b>  x1	<b>(E1)</b>  6,3x11 x5
----------	--	---

<b>5</b>	<b>(E7)</b>  x2	<b>(E1)</b>  6,3x11 x10
----------	---	---

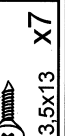
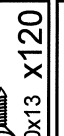
<b>6</b>	<b>(E3)</b>  x2	<b>(E1)</b>  6,3x11 x4
----------	---	--

<b>7</b>	<b>(E4)</b>  x2	<b>(E1)</b>  6,3x11 x4	<b>(A1)</b>  x2
----------	---	--	---

<b>8</b>	<b>(L4)</b>  x2	<b>(S4)</b>  3,5x13 x7	<b>(S3)</b>  3,0x13 x120	<b>(S5)</b>  x2
----------	---	---	--	---

<b>(J20)</b>  L=1062 mm X1	<b>(J22)</b>  L=1974 mm X1
---	---

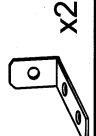
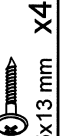
<b>9</b>	<b>(J11)</b>  x2	<b>(P13)</b>  3,5x13 mm x4
----------	--	--

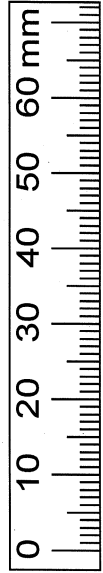

# 1

 W1 x16	 T6 x24	 F7 x2	 B1 $\phi$ 8x28 x8
 T1 x8	 S3 3.0x13 x2	 M1 x8	 M1 x8

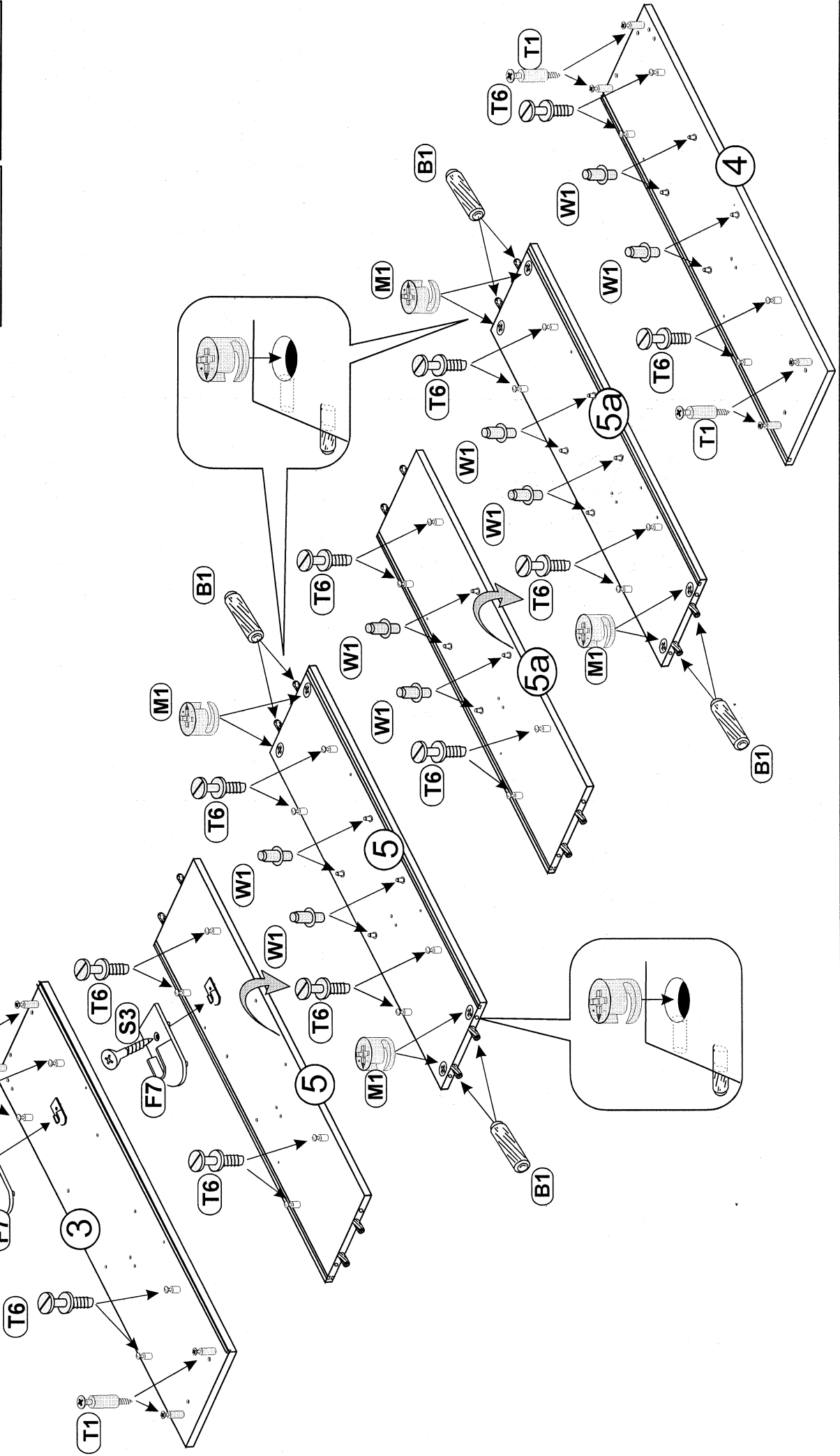

2

- M1 x8
- L1 x1
- T1 x8
- B1 φ 8x28 x10
- T6 x4

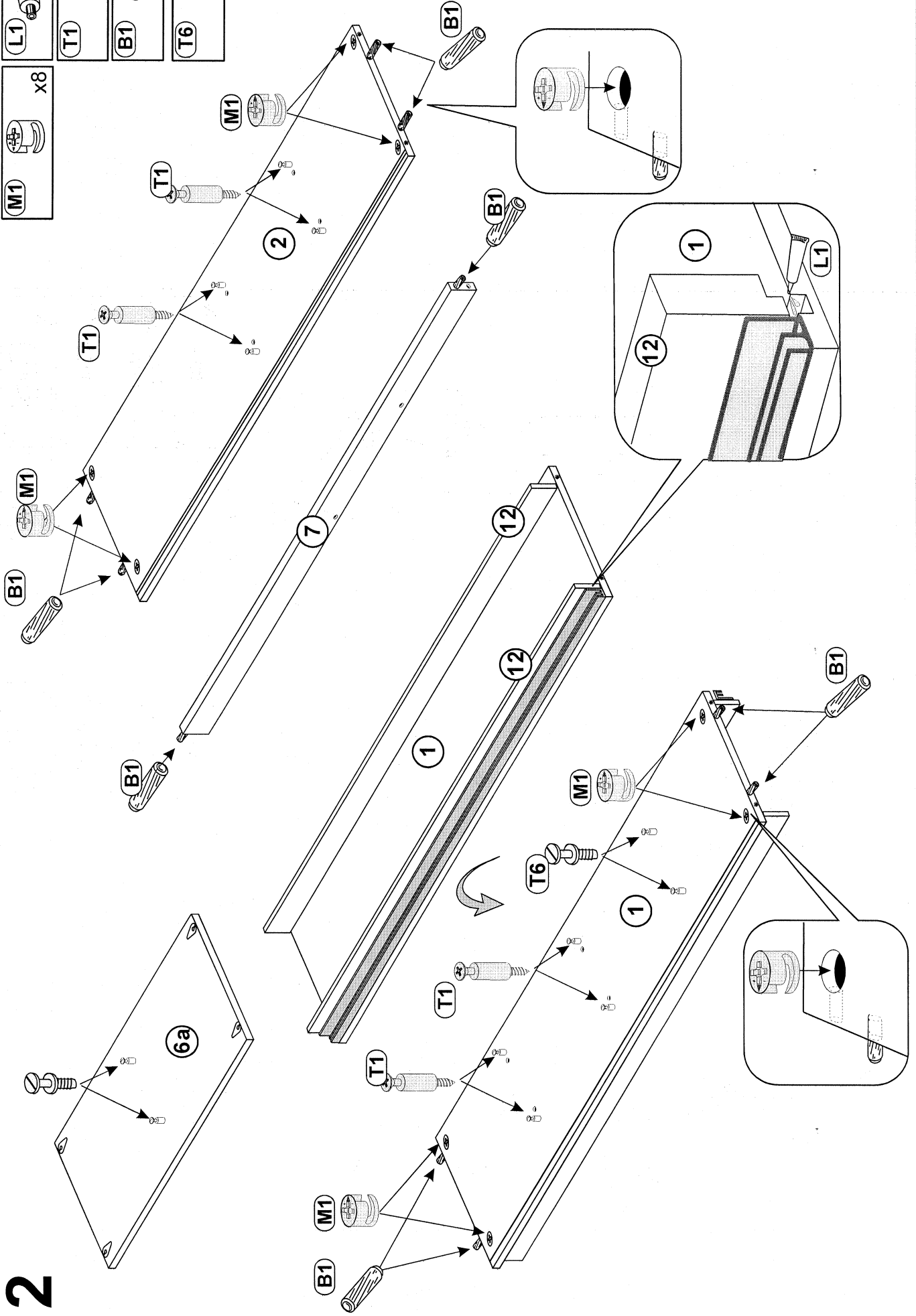

**3**

- (K1)** 7x50 x2
- (C1)**  $\phi 2$  x1
- (M6)**  x8
- (J22)** L=1974 mm x1
- (P16)** 4,2x12 x8

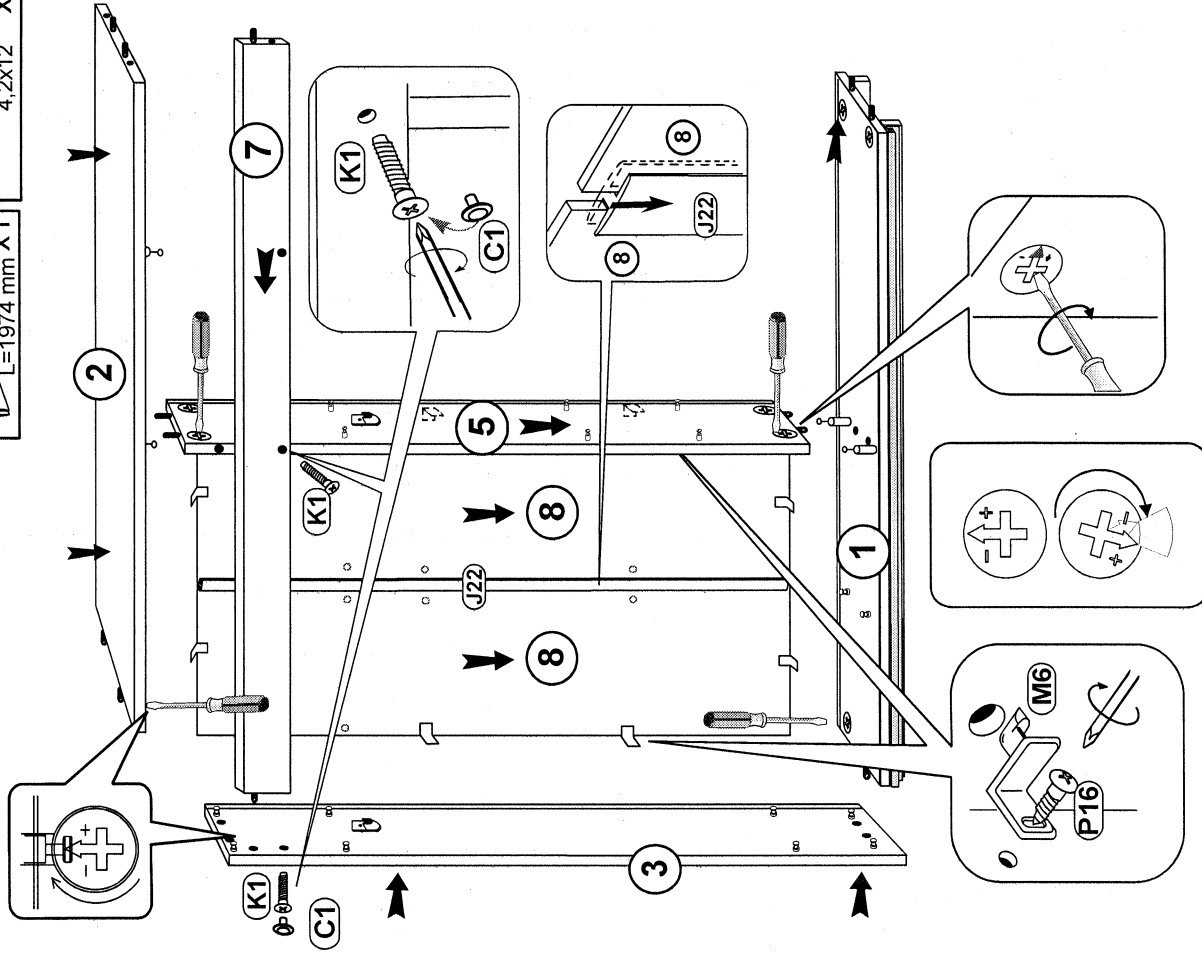

**4**

- (K1)** 7x50 x2
- (C1)**  $\phi 2$  x1
- (P16)** 4,2x12 x12
- (M6)**  x12

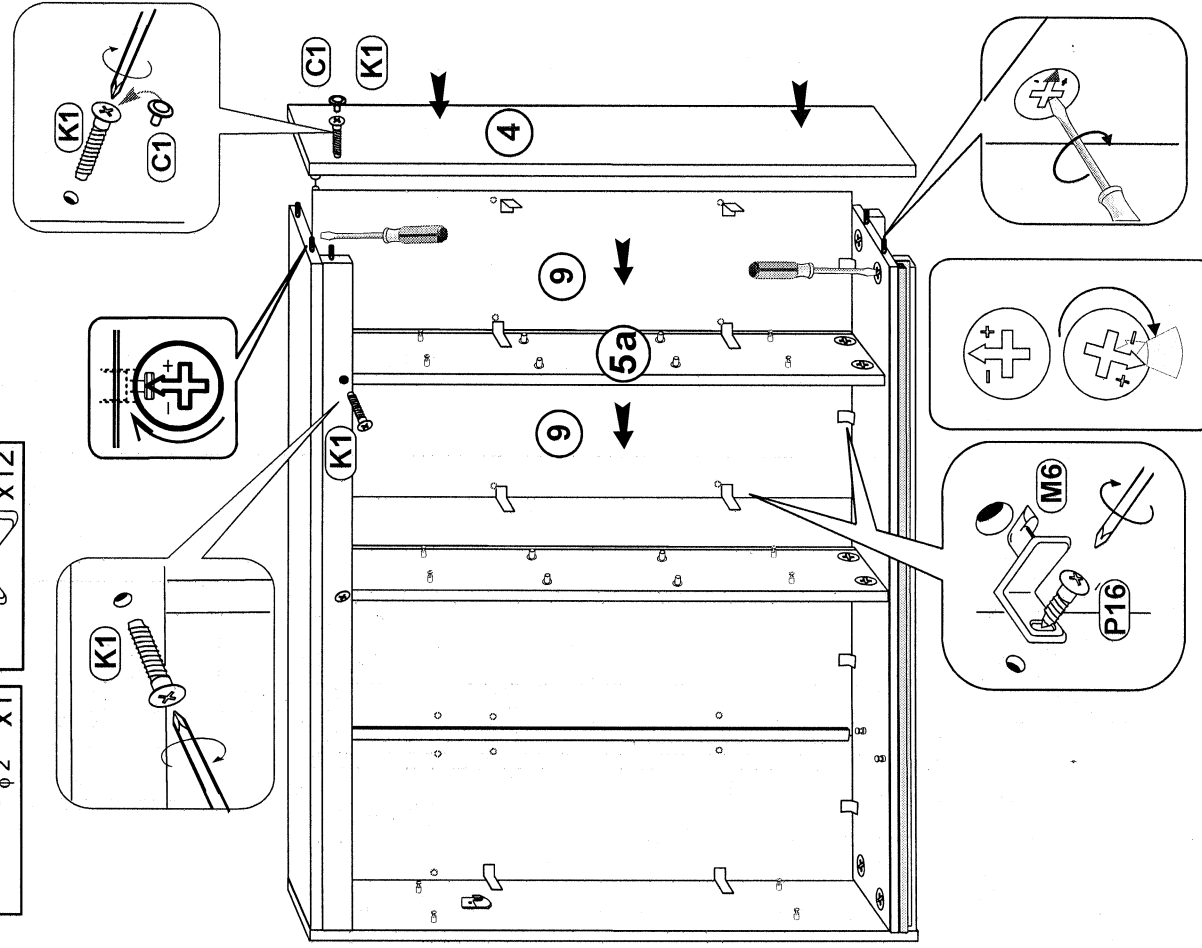

5

- P16** 4,2x12 x2
- M6** x2
- J20** L=1062 mm X1

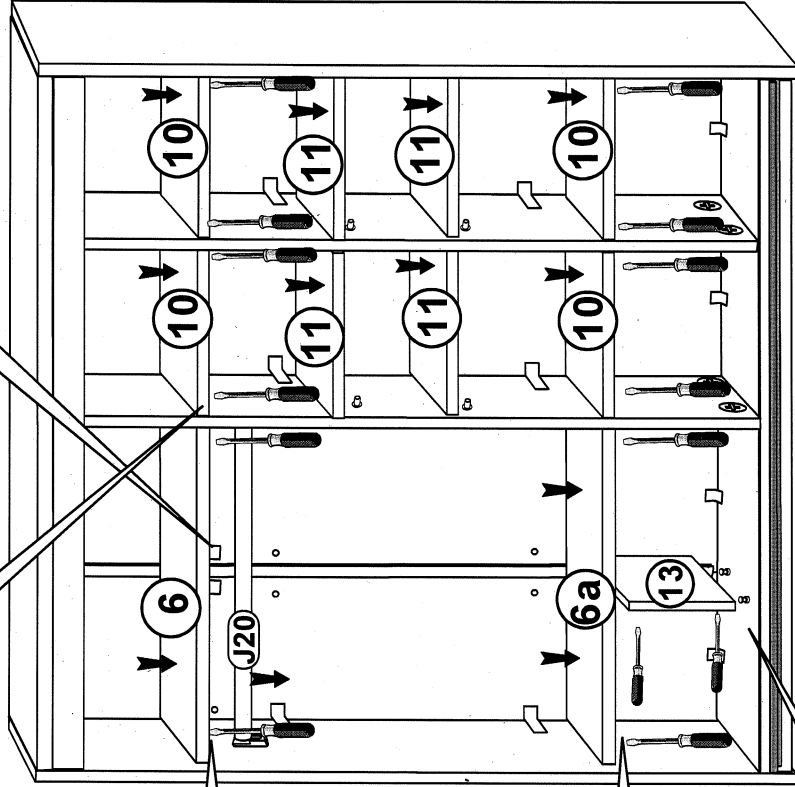
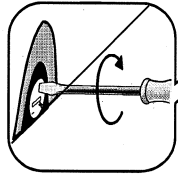
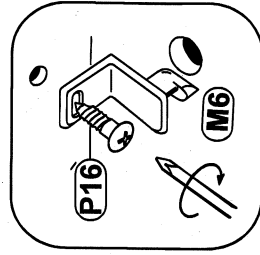

6

- S4** 3,5x13 x7
- C2** Ø15 x16
- C3** Ø10 x6

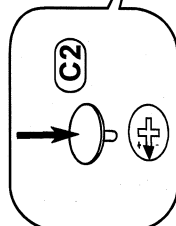
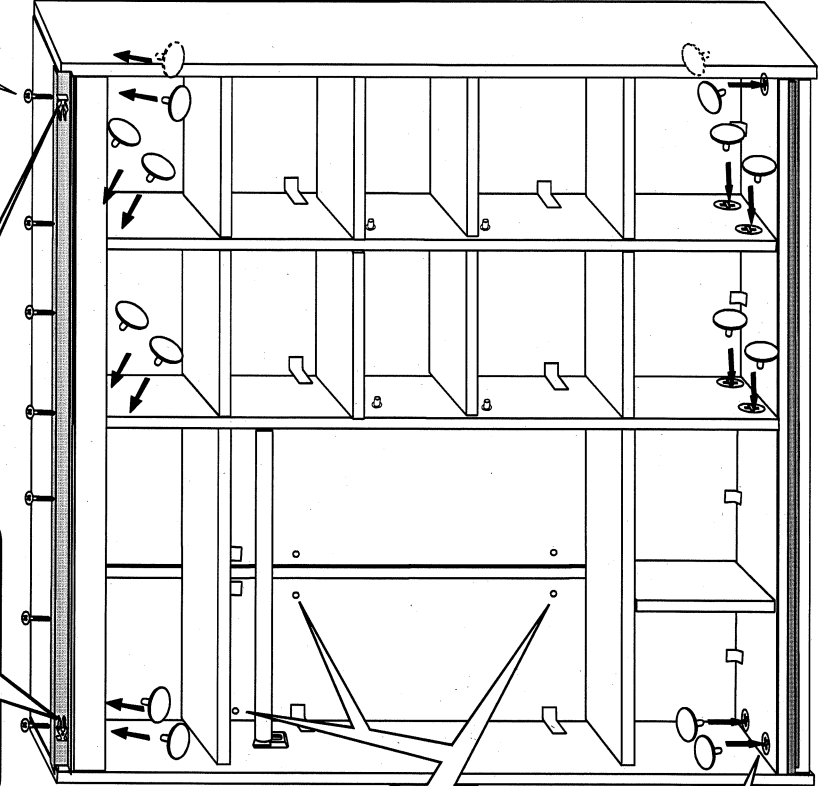
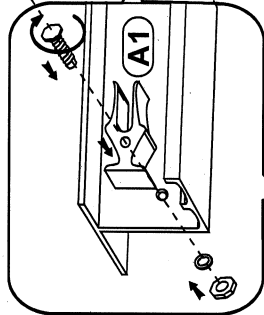
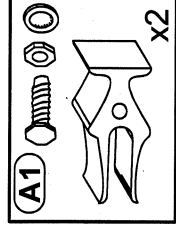

7

- S3 3,0x13 x60
- E3 x2
- E7 x2
- S5 x1

- E1 6,3x11 x14

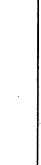
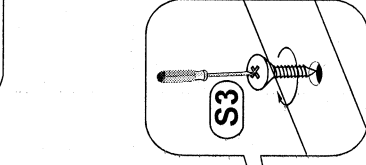
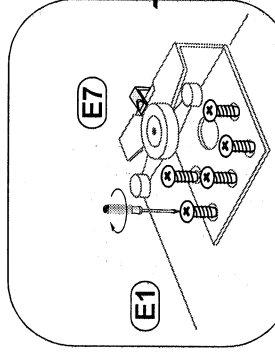
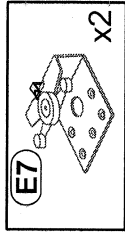
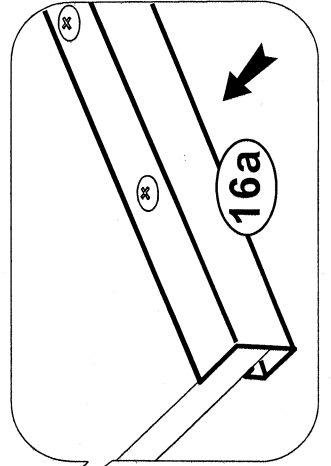
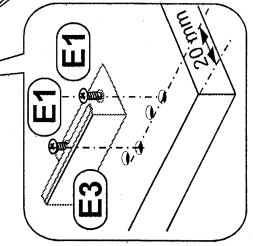
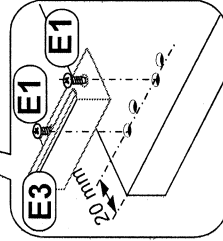
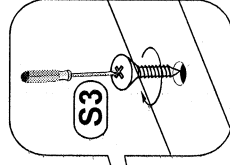
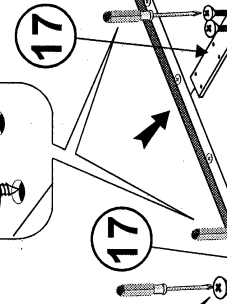
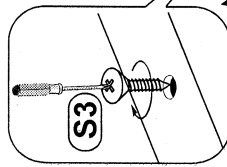
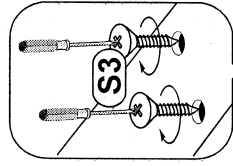
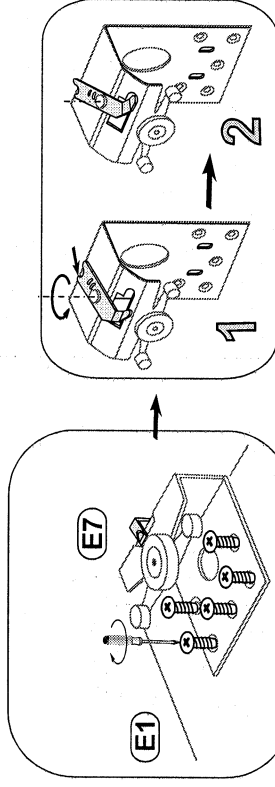
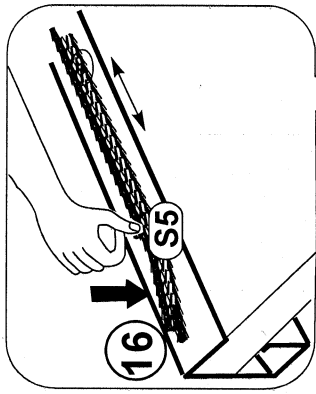

- (E4) x2
- (E9) x1
- (E1) 6,3x11 x14
- (S5) x1
- (E11) x1

- (S3) 3,0x13 x60
- (E5) x1

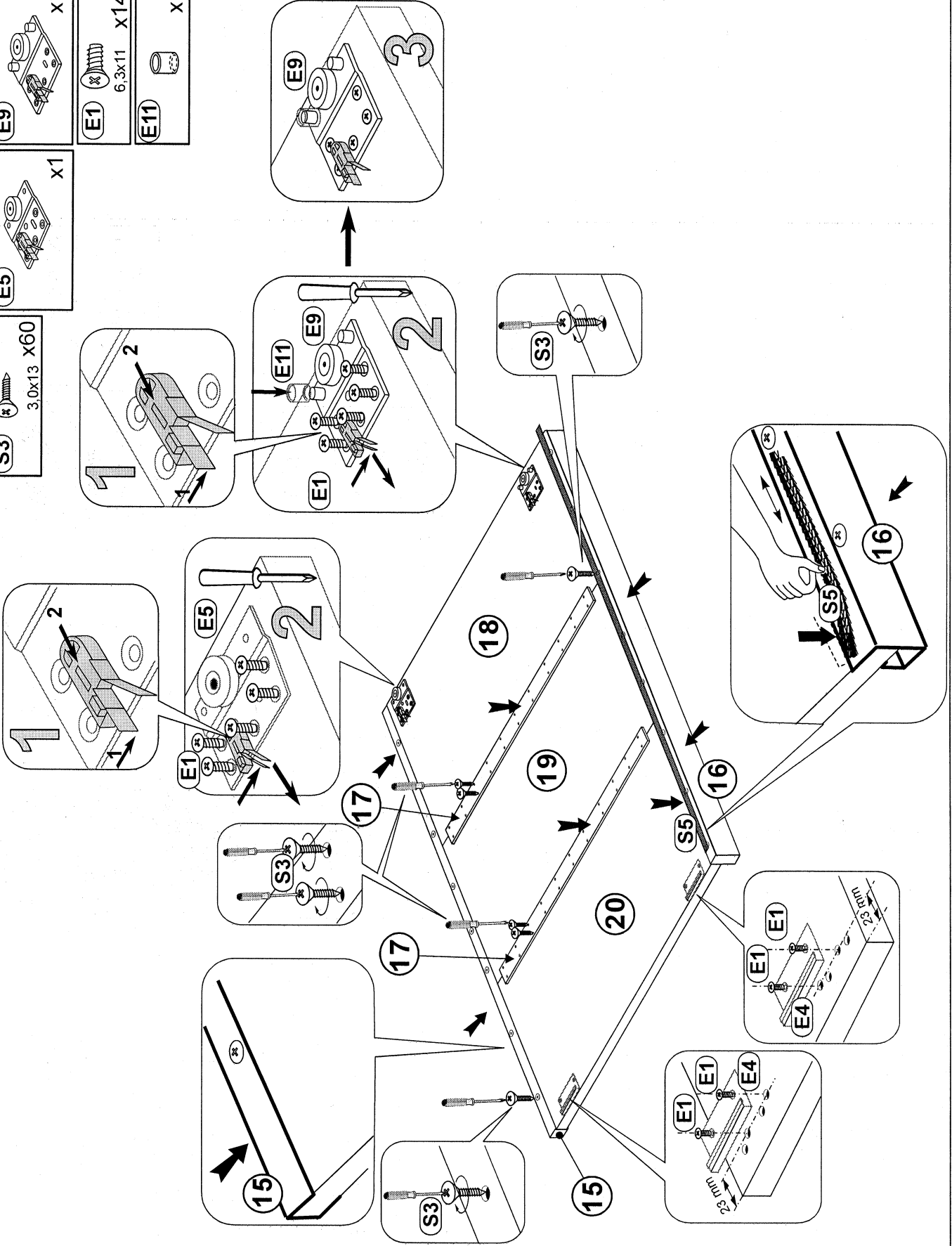



9

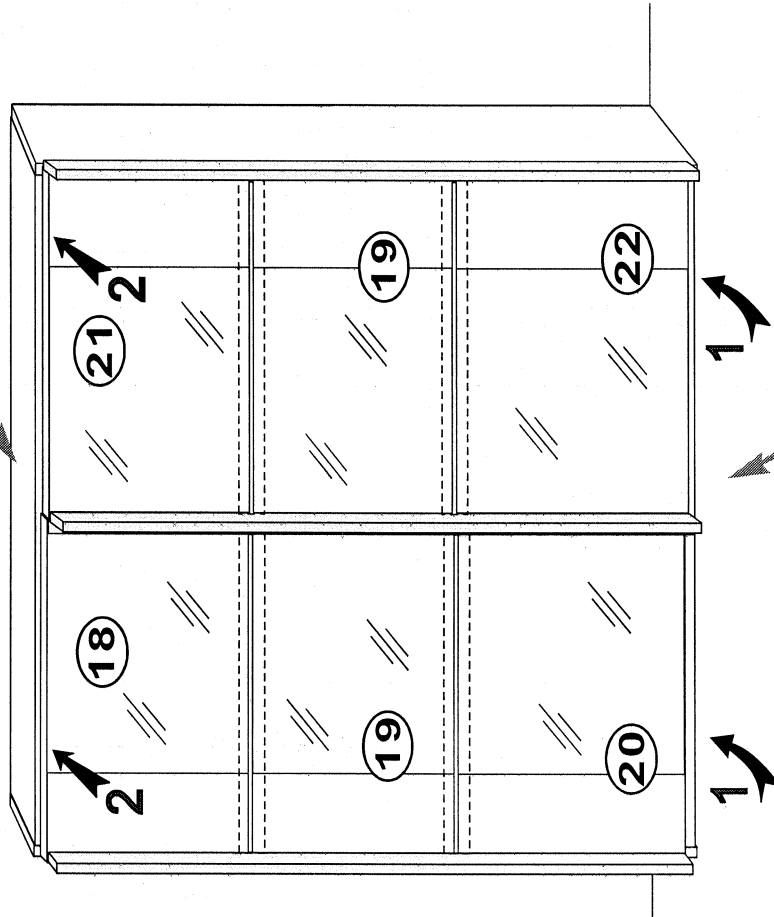
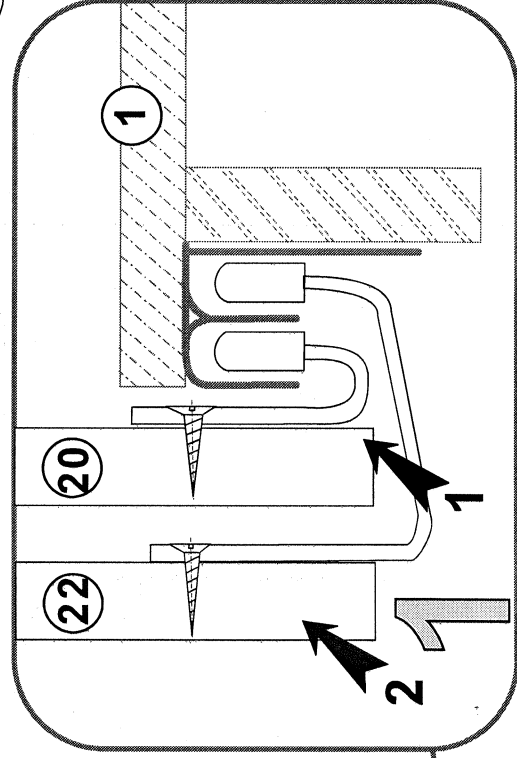
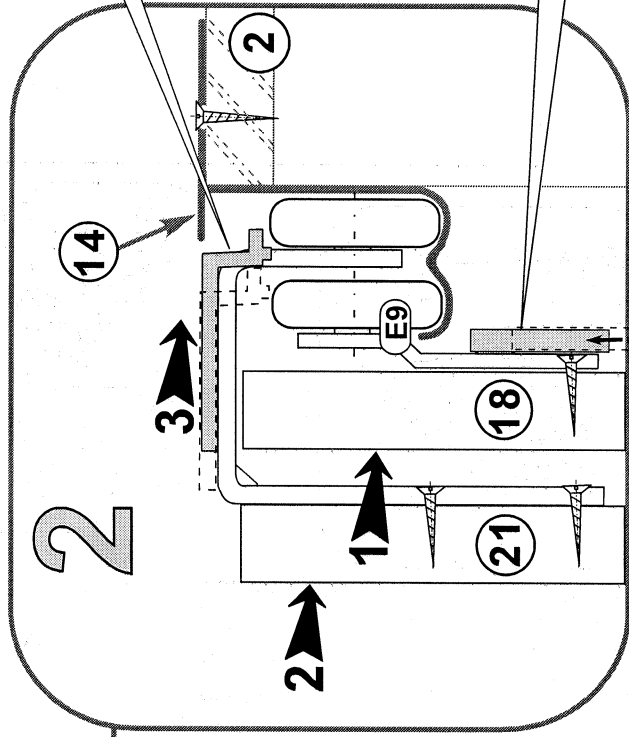
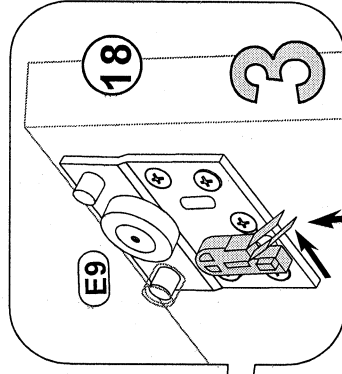
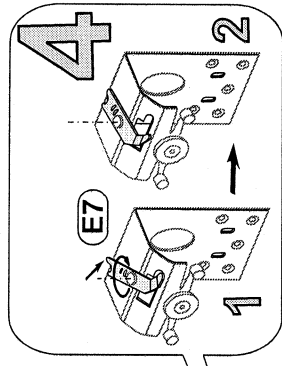

# 10

