





NR 1

B1  ϕ 8x28 x27

M1  x22

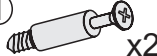
T1  x22

K1  \varnothing 7x50mm x1

C2  x2

W1  x8

J23  x16+12

F1  x8

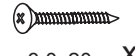
S4  3,0x20 x8

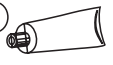
L1  x1

NR 2

F33  x4

P13  3,5x13 x68+16

F12  x17

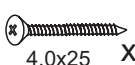
S5  4,0x25 x4

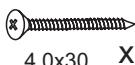
S6  4,0x30 x2

NR 3

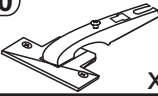
Y0  x4

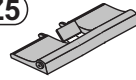
Z5  x2

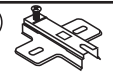
D7  x4

E3  6,3x13 x8

S8  4x13 x8

NR 4

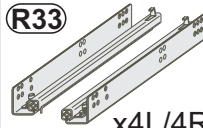
R33  x4L/4R

E24  6,0x11 x12

E8  6,0x8 x4

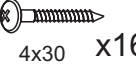
P7  4x30 x16

T2  5x35mm x8

M2  12x10mm x8

NR 5

U22  x6

A18  4,0x25 x6

NR 6

J44  x1

P13  3,5x13 x1

G22  ϕ 18 x2

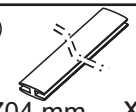
L2  L=704 mm x2



1

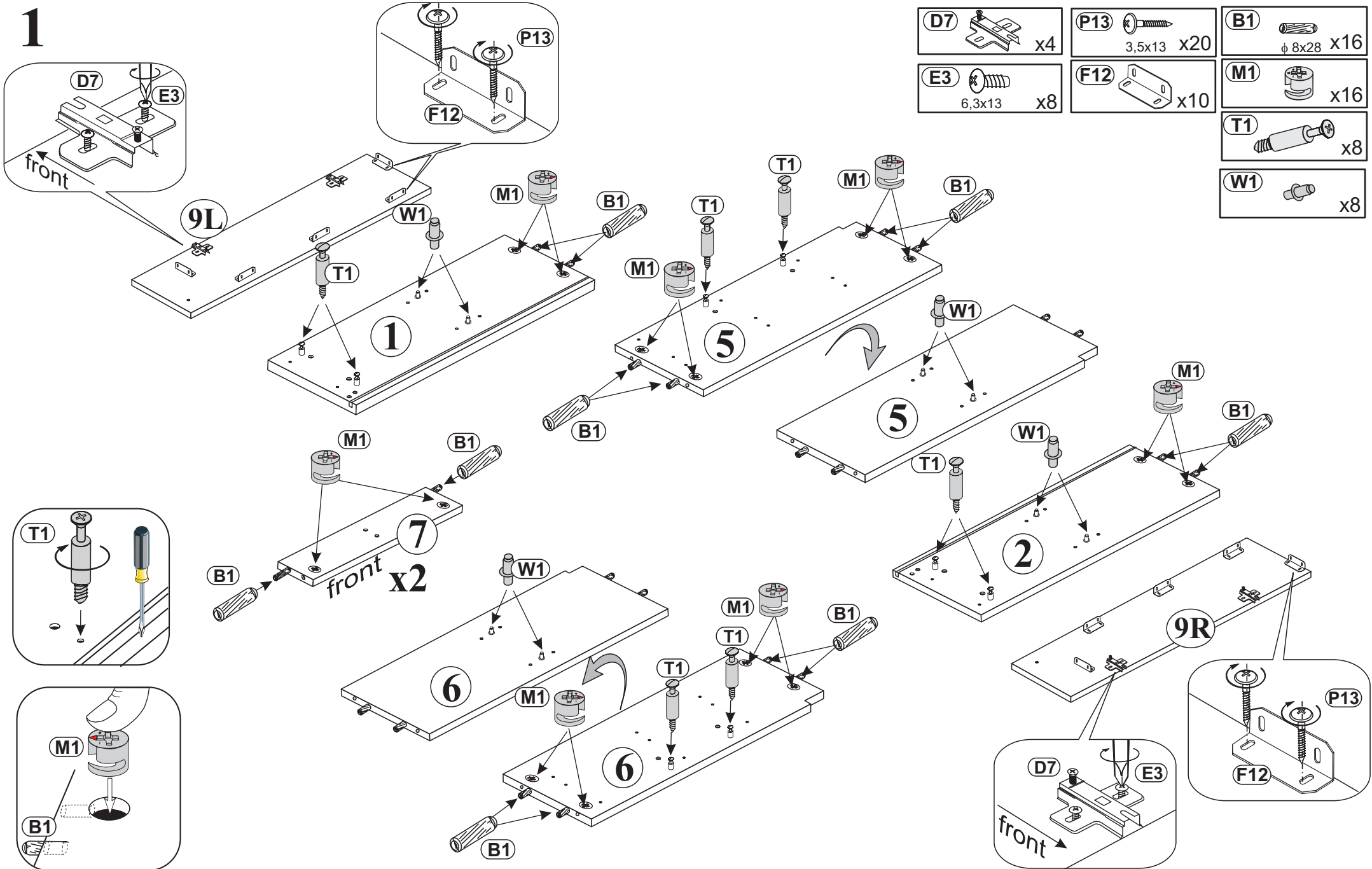

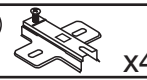

D7  x4

P13  3,5x13 x20

B1  ϕ 8x28 x16

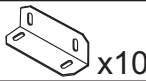
E3  6,3x13 x8

F12  x10

M1  x16

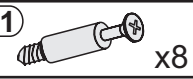
T1  x8

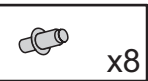
W1  x8

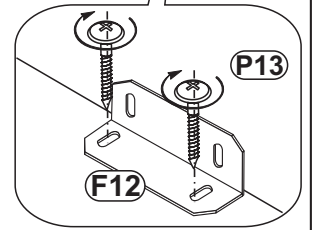
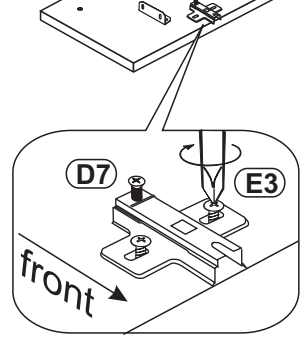
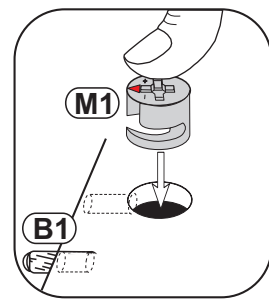
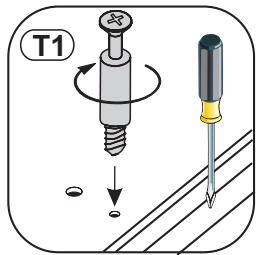

2

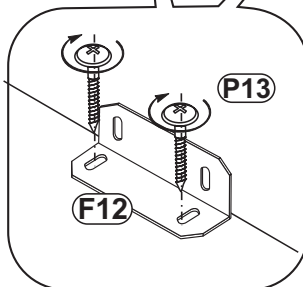
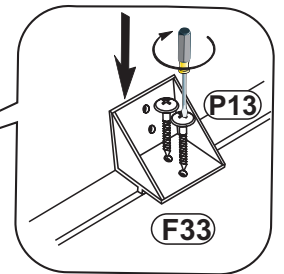
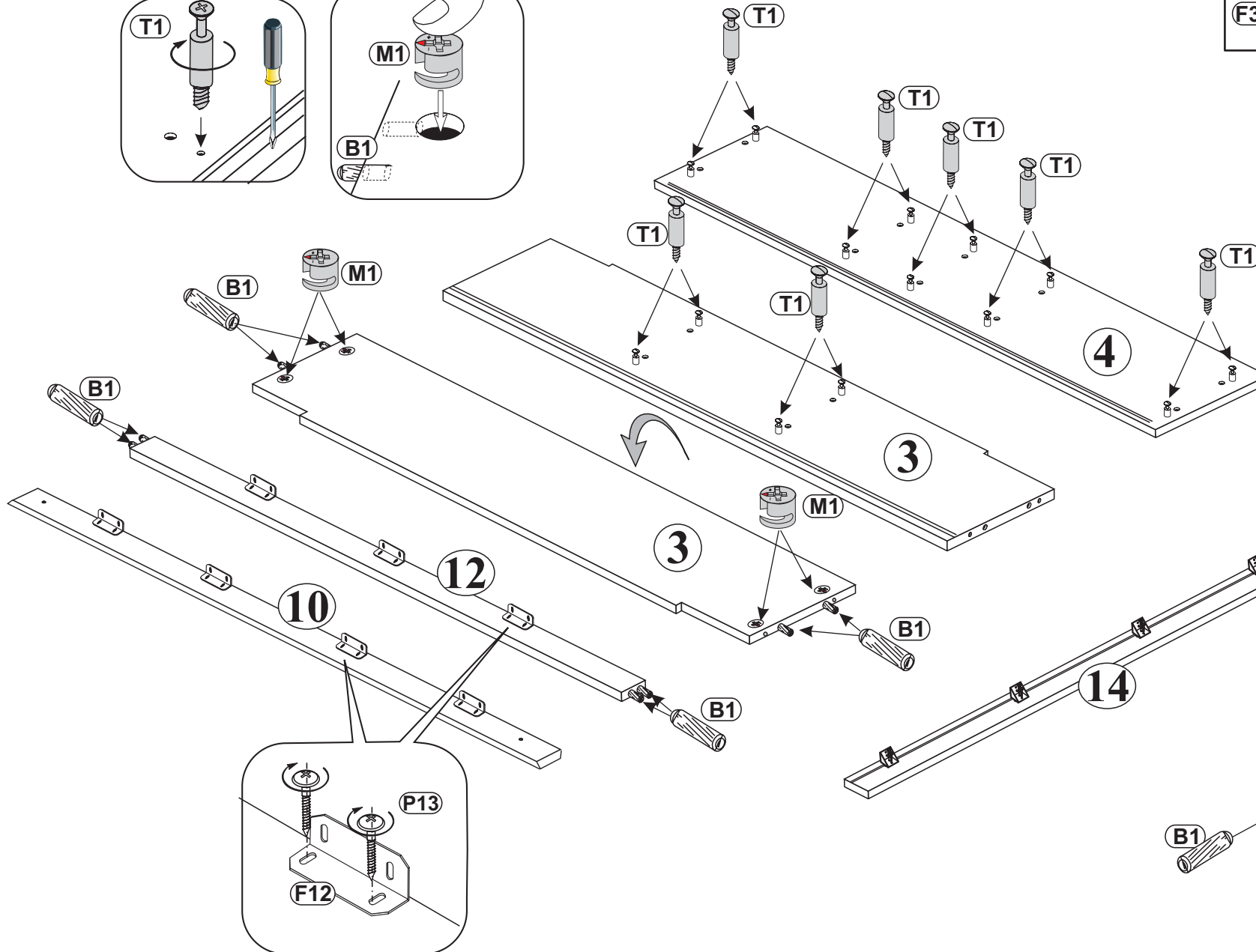
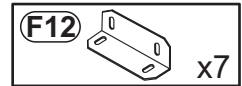
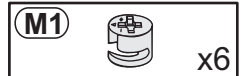
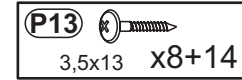
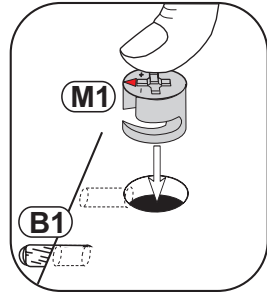
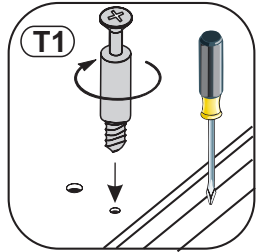

3

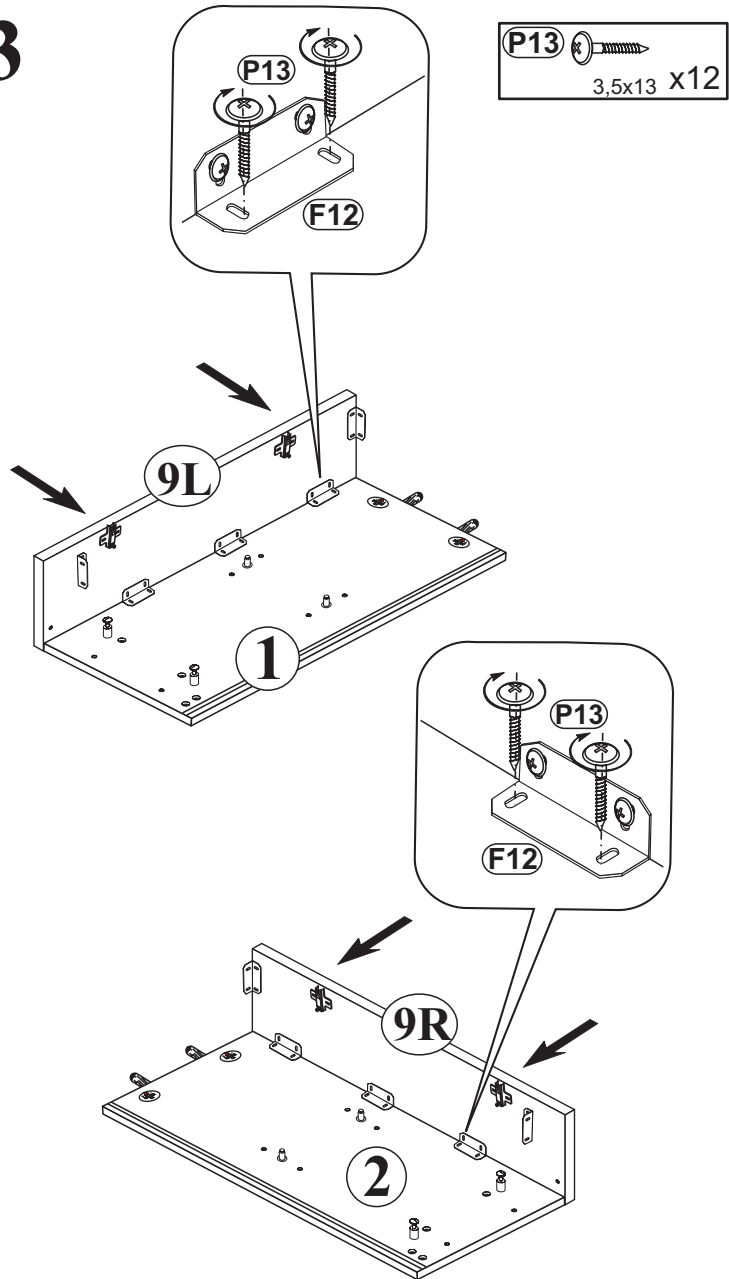

4

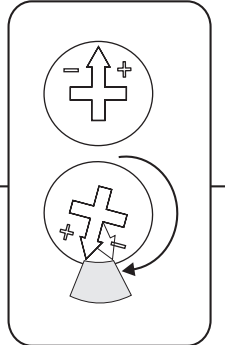
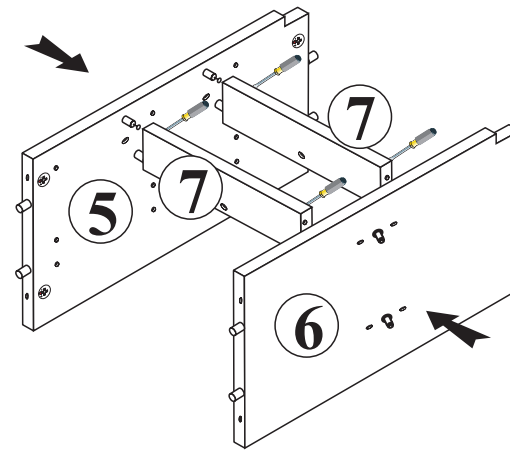

5

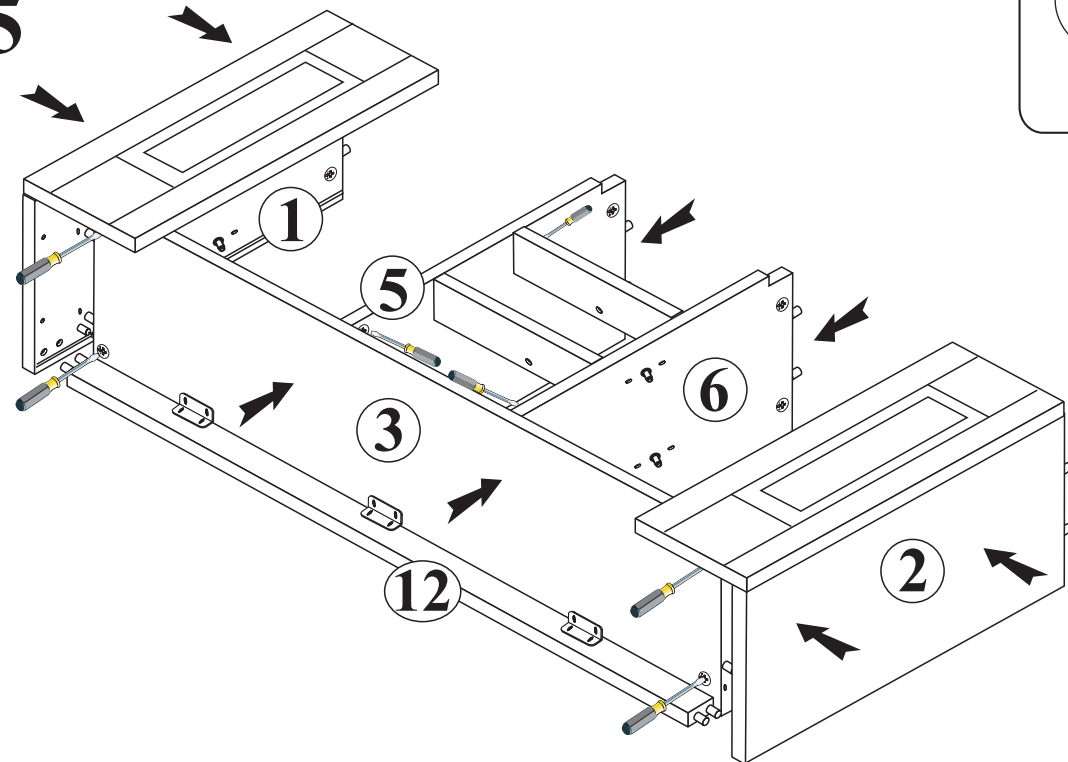

6

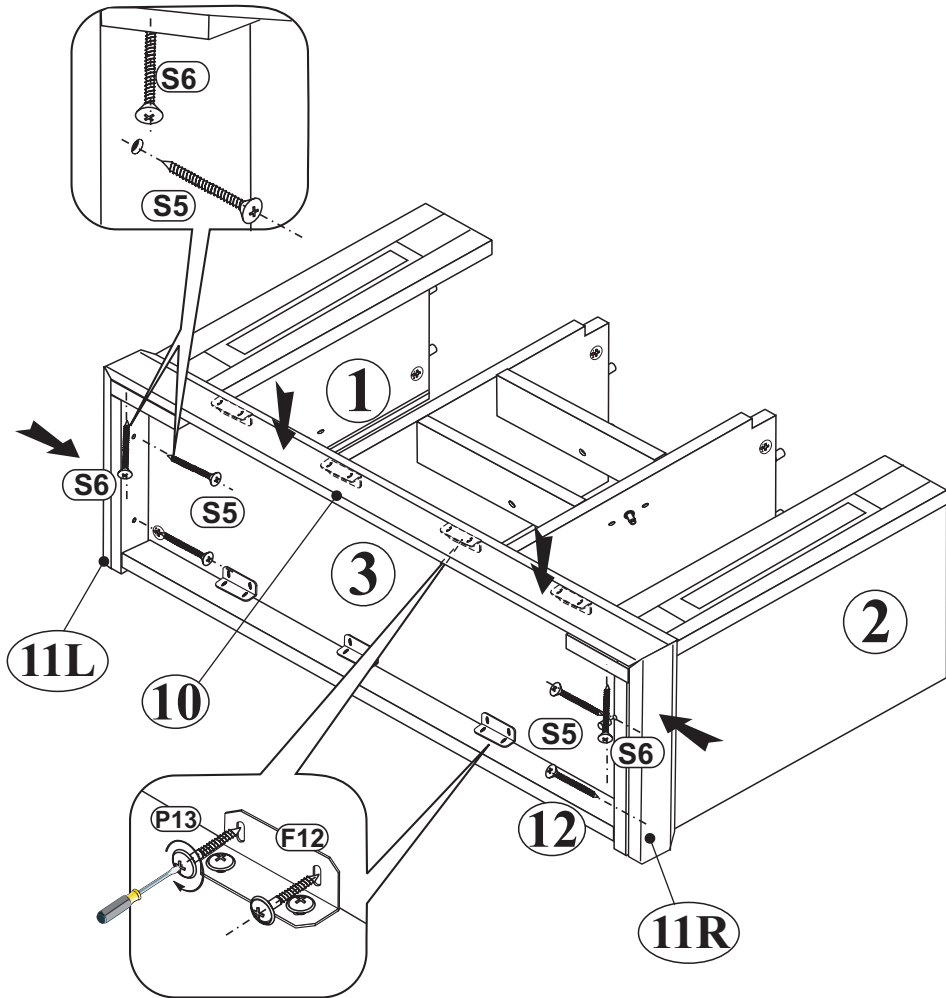
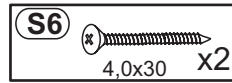
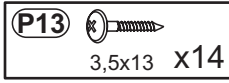
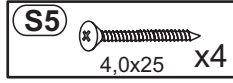

7

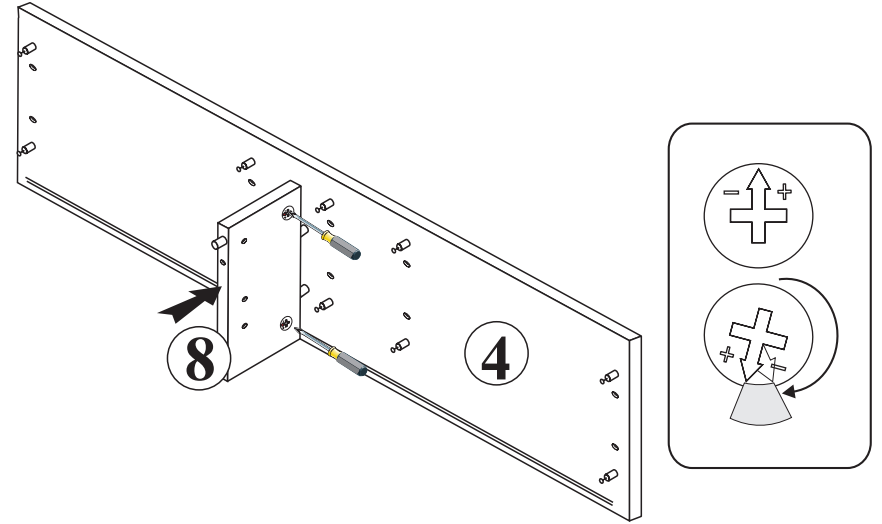

8

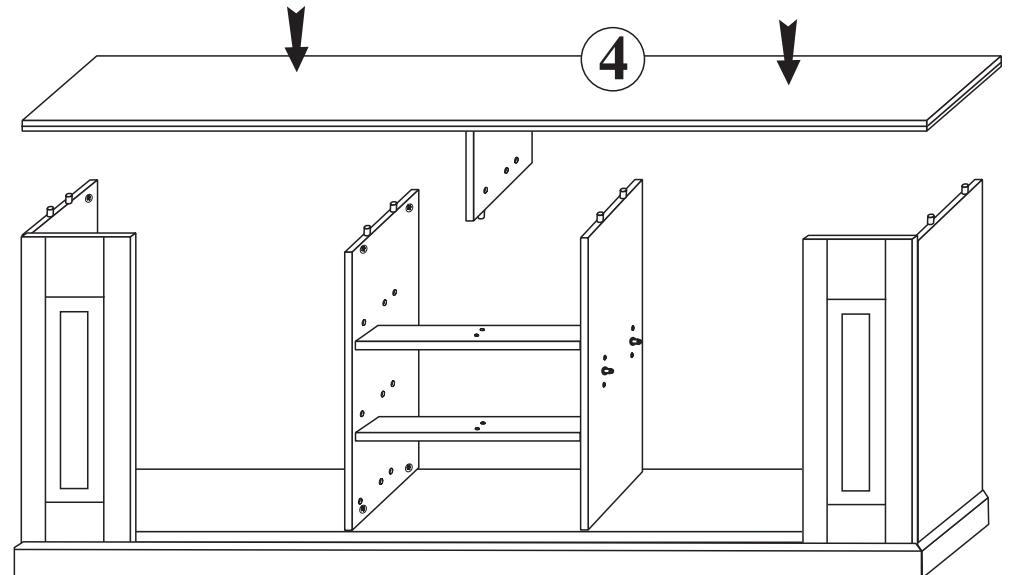

9

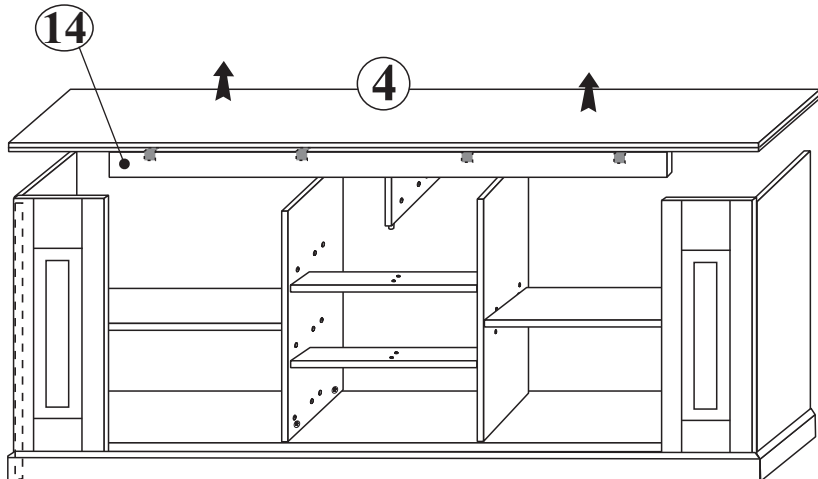
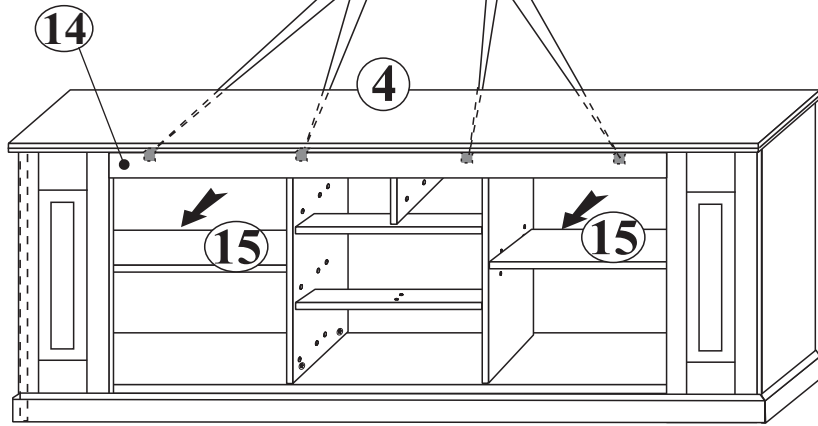
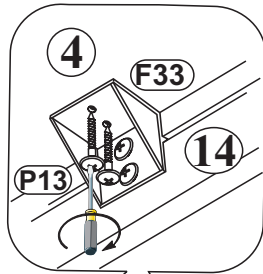
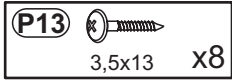

10

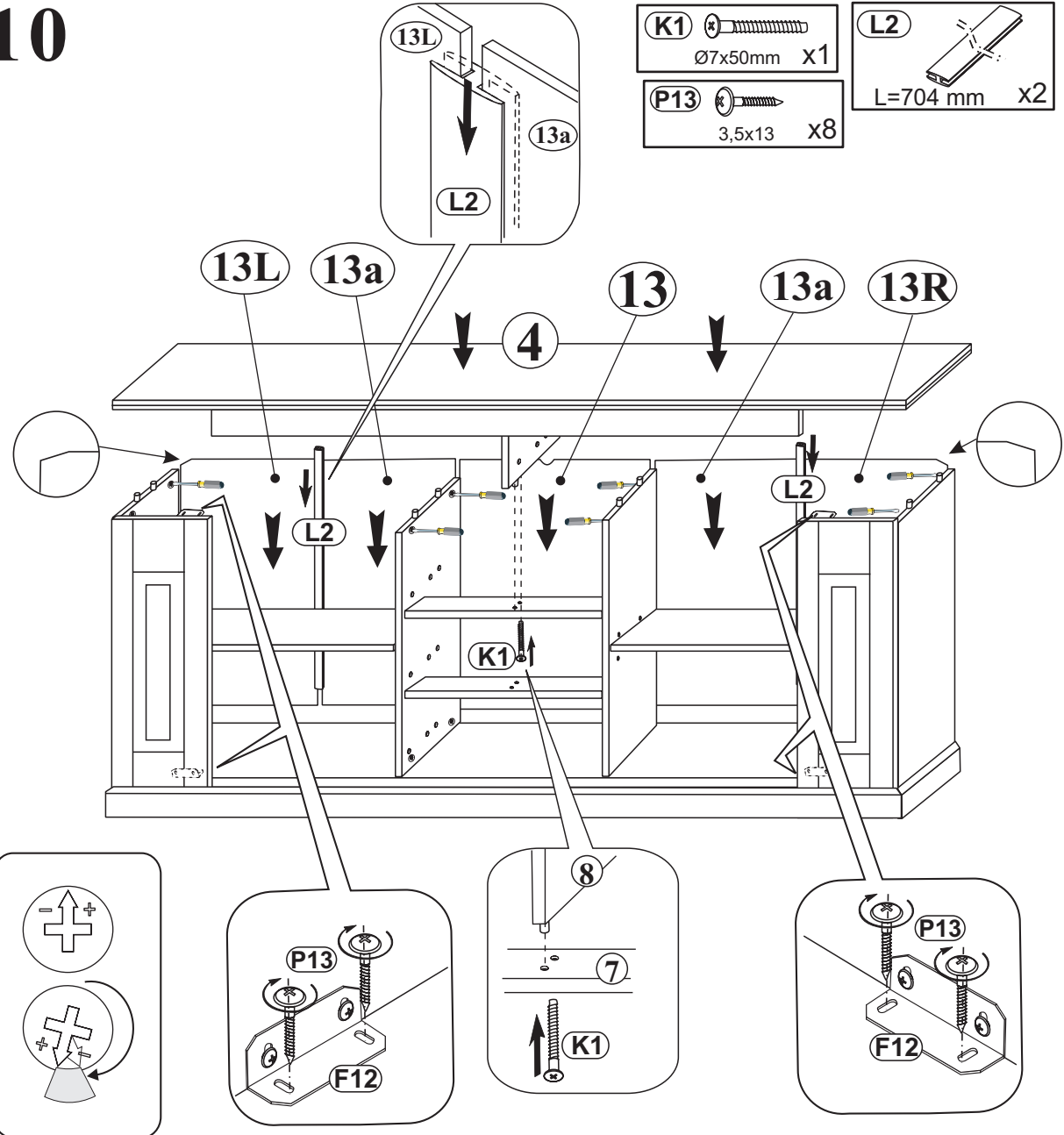
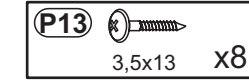
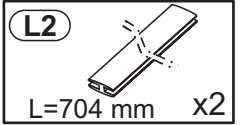
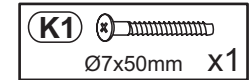

11

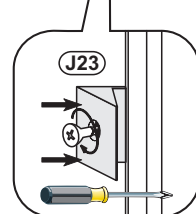
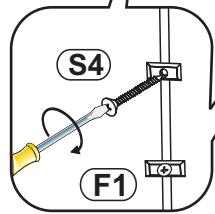
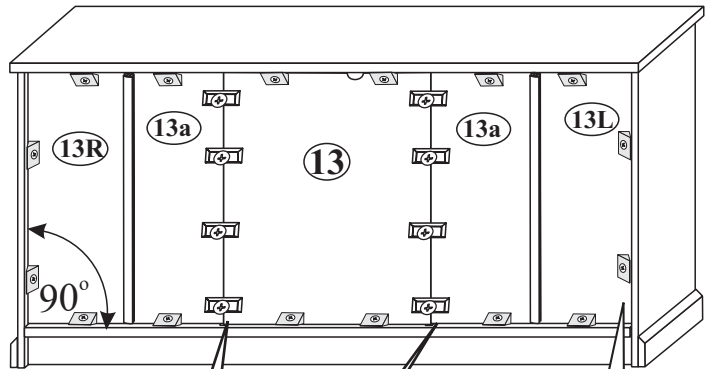
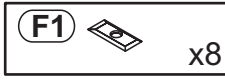
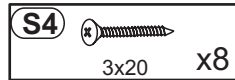

12

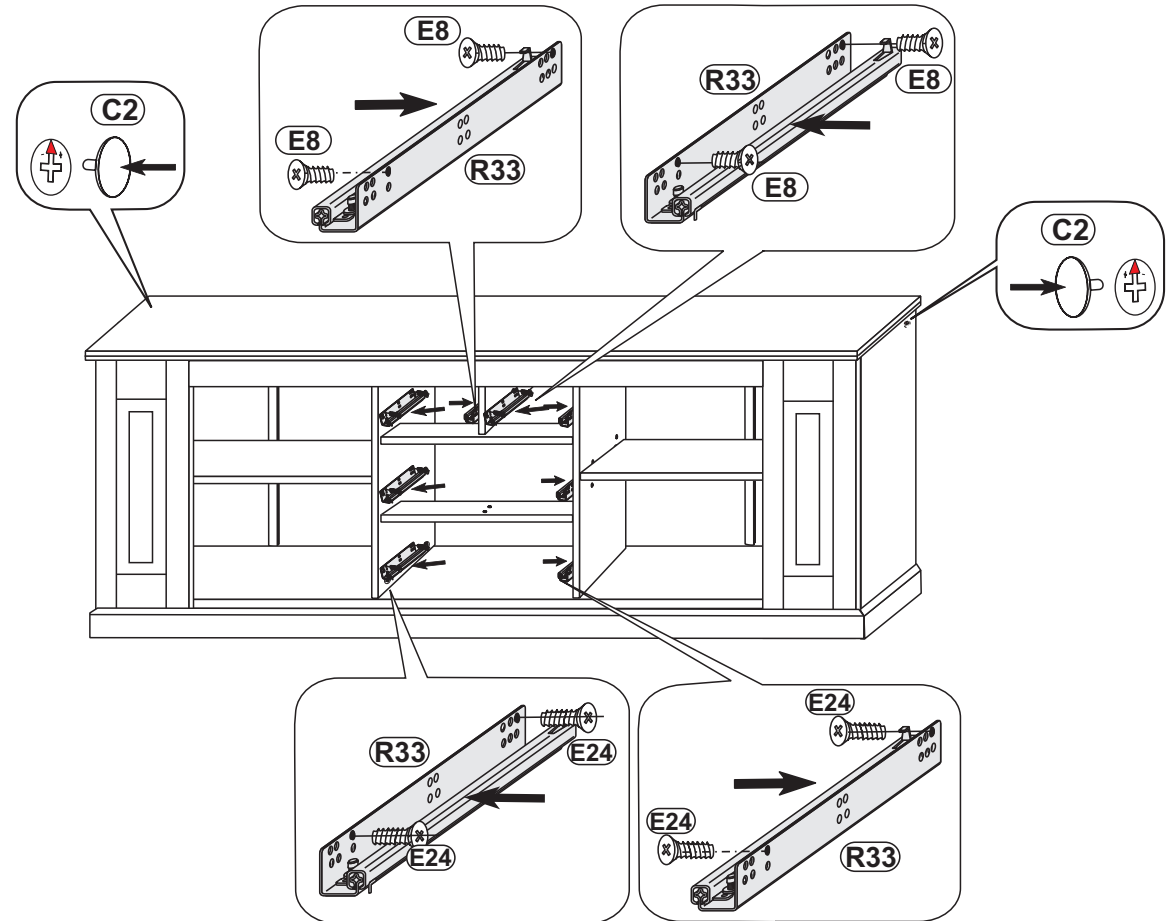
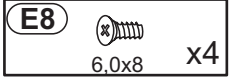
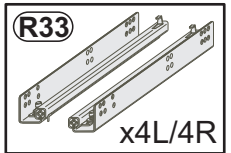
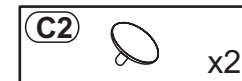

13

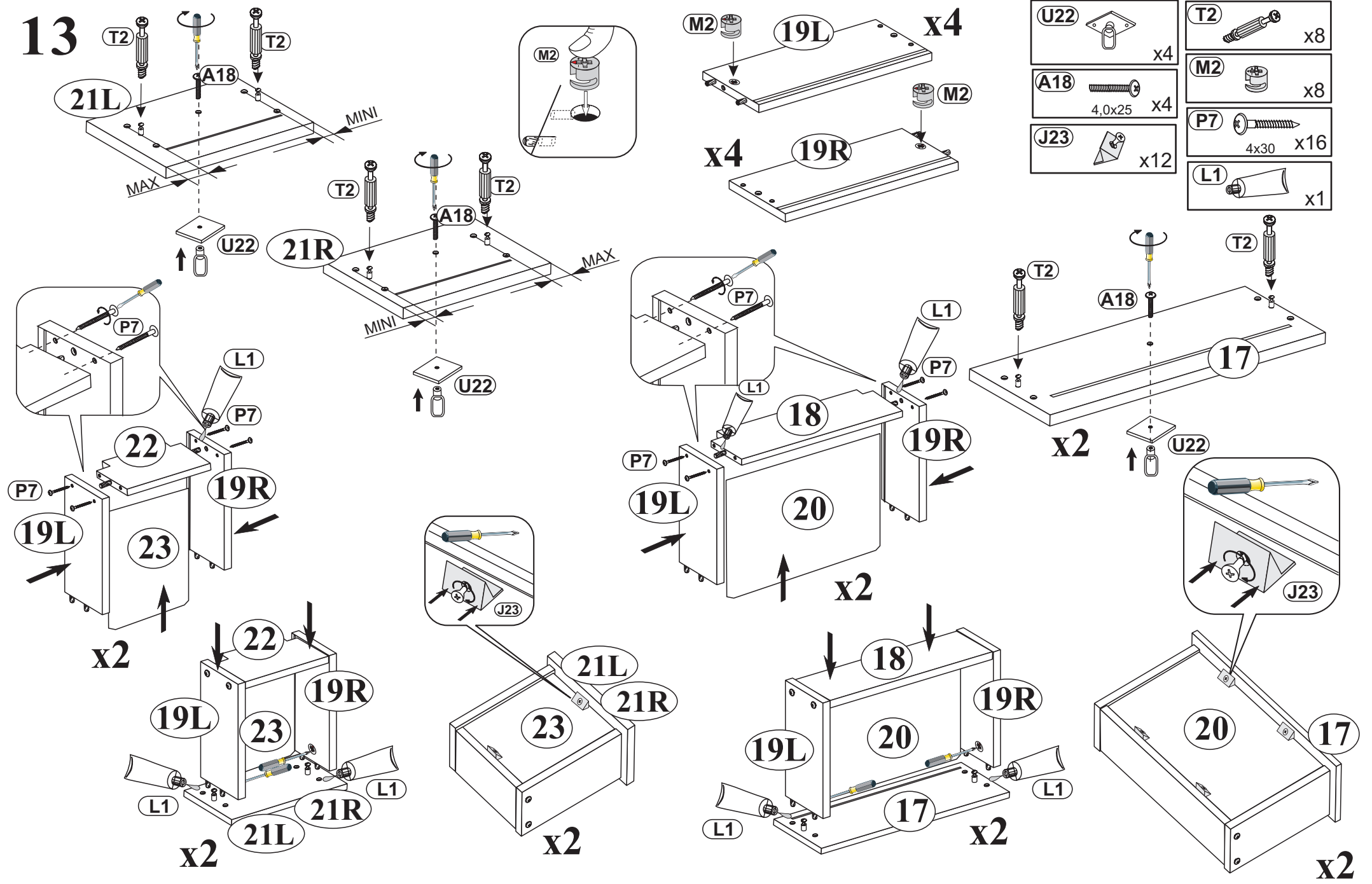

14

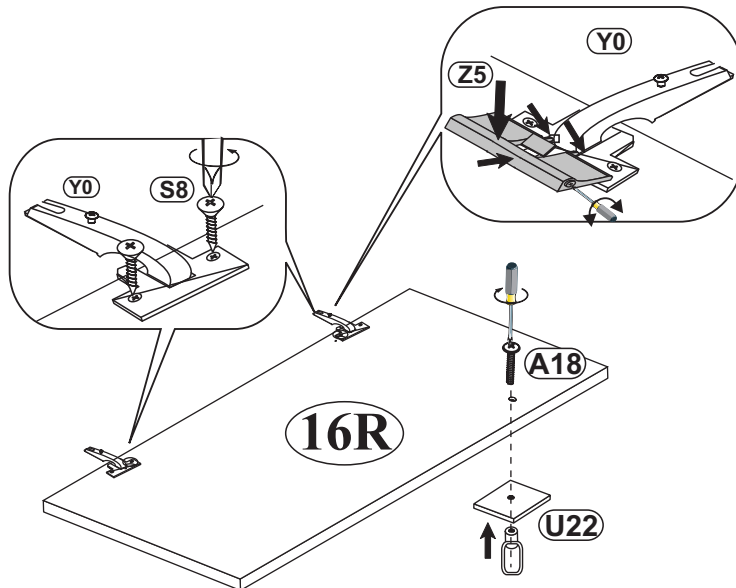
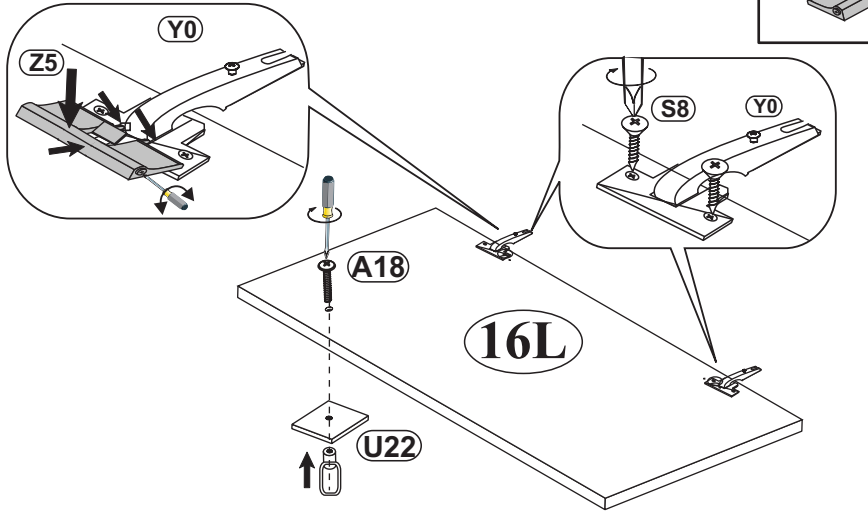
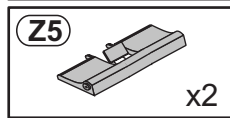
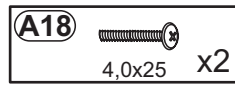
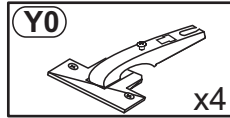
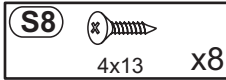
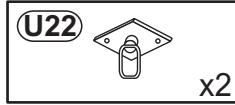

15

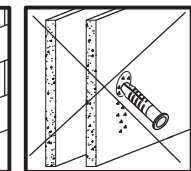
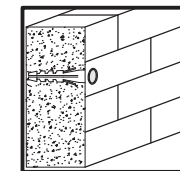
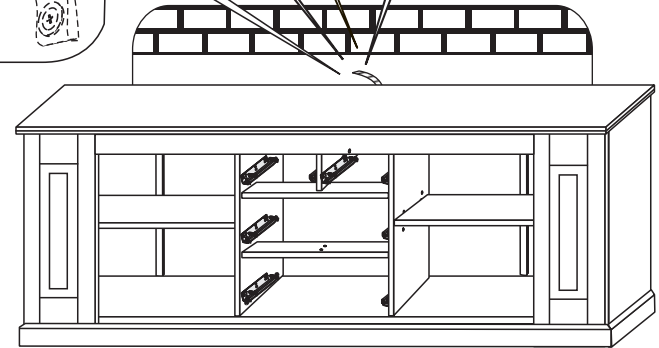
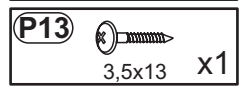
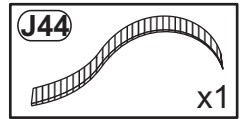
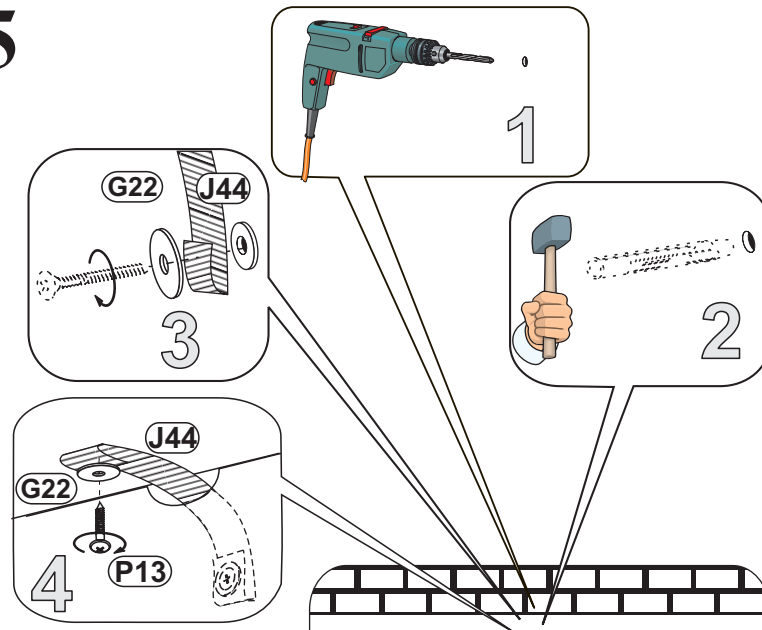

16

