

SAV  
 SPAREPARTS  
 KUNDERDIENST  
 POS VENTAS  
 SERVICE NA VERKOOP  
 SERVIZIO POST- VENDITA  
 SERVIÇO DEPOIS DE VENDA  
 SERWIS POGWARANCY JNY

313827-00  
*Trio*

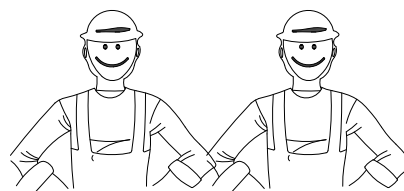

**0H 30MN**

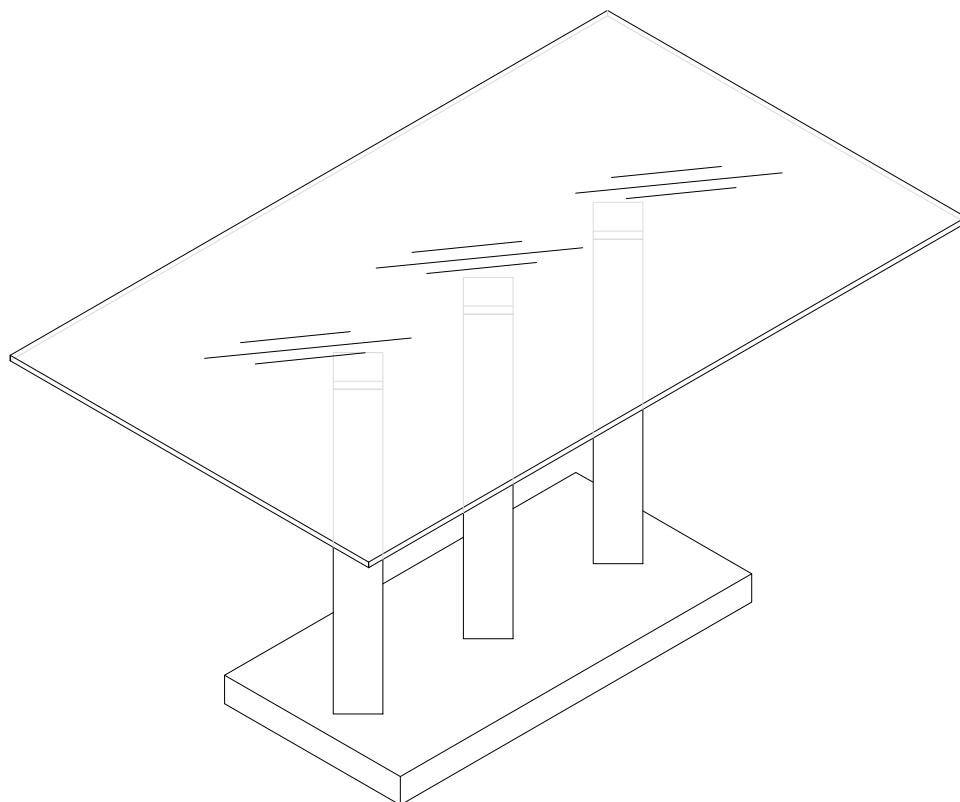
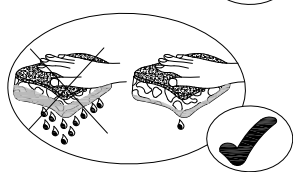
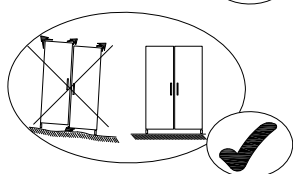
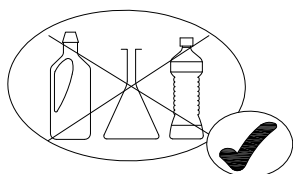
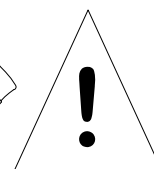

**(FR) SECURITE**

RESPECTER LES INSTRUCTIONS DE MONTAGE DECRITES DANS LA NOTICE

**(EN) CAUTION**

FOLLOW CAREFULLY THE ASSEMBLING INSTRUCTIONS DESCRIBED IN THE DIRECTIONS

**(DE) SICHERHEITSVORSCHRIFTEN**

BEACHTEN SIE BITTE UNBEDINGT DIE ANGEGBENEN AUFBAUVORSCHRIFTEN

**(ES) SEGURIDAD**

RESPECTAR LAS INSTRUCCIONES DE MONTAJE DESCRIBIDAS EN EL FOLLETO

**(NL) VEILIGHEID**

DE IN DE GEBRUIKSAANWIJZING BESCHREVEN INSTRUCTIES RESPECTEREN

**(IT) SICUREZZA**

RISPETTARE LE ISTRUZIONI DI MONTAGGIO DESCRITTE NEEL' AVVERTENZA

**(PT) SEGURANCA**

RESPEITAR AS INSTURAÇOS DE MONTAGEH DESCRVEDAS NA INSTRUÇÕES DE USO

**(PL) UWAGA**

PROSZĘ PRZESTRZEGAĆ INTRUCJI MONTAŻU

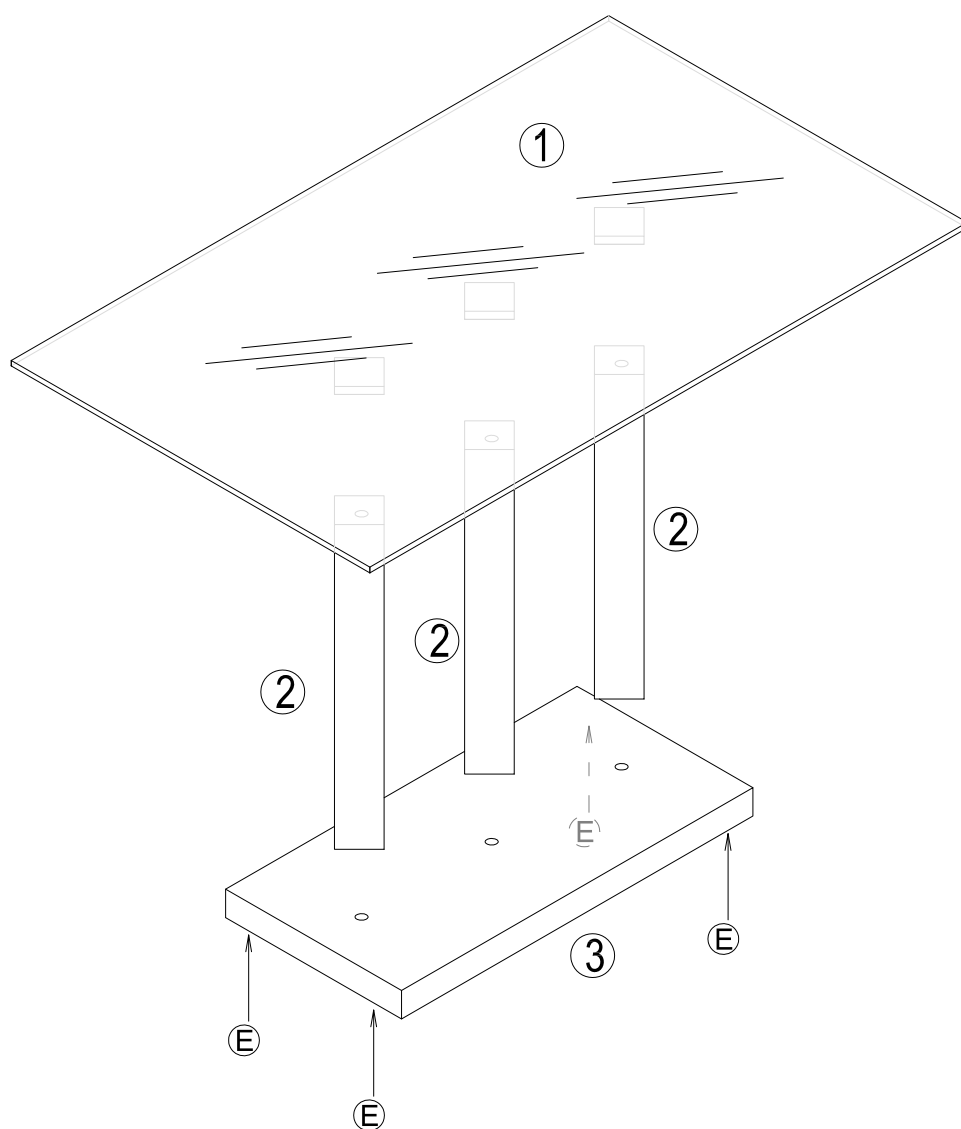

① x 1	1100x600 x8 mm
② x 3	80x80x370 mm
③ x 1	800x400 x35 mm

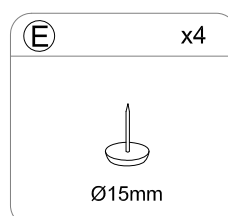
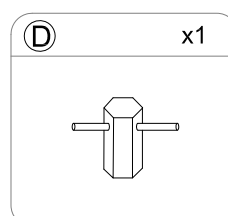
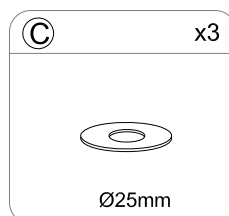
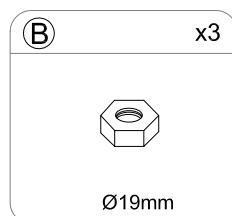
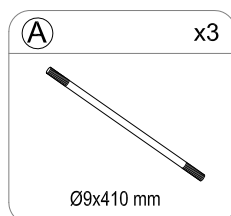

1

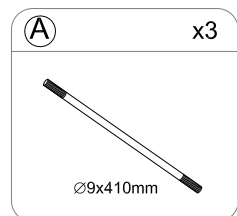
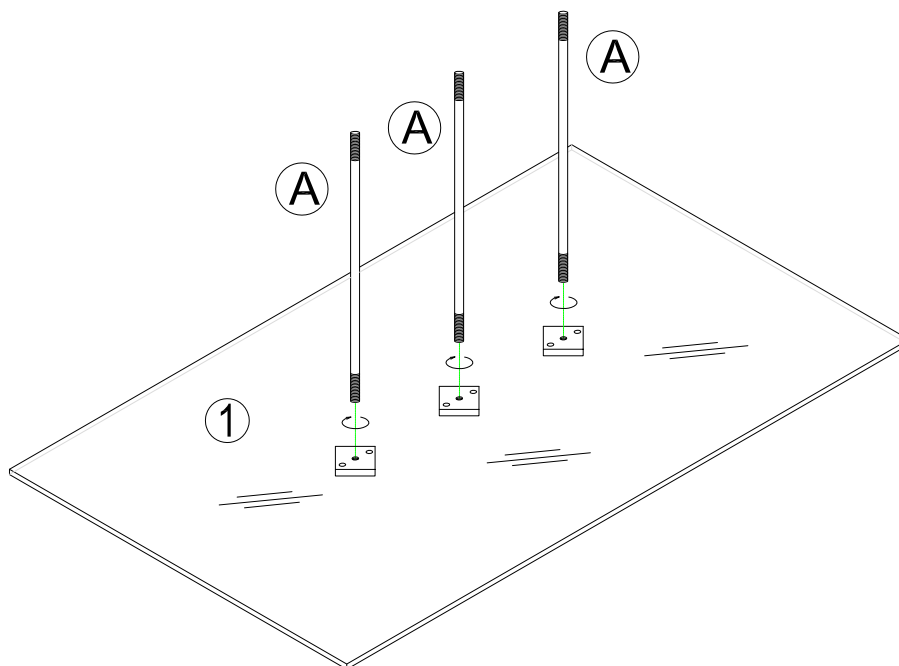

2

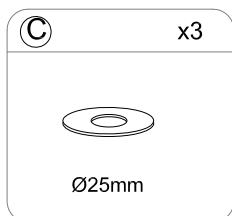
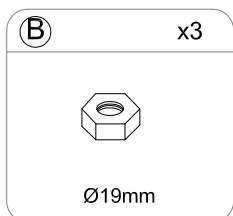
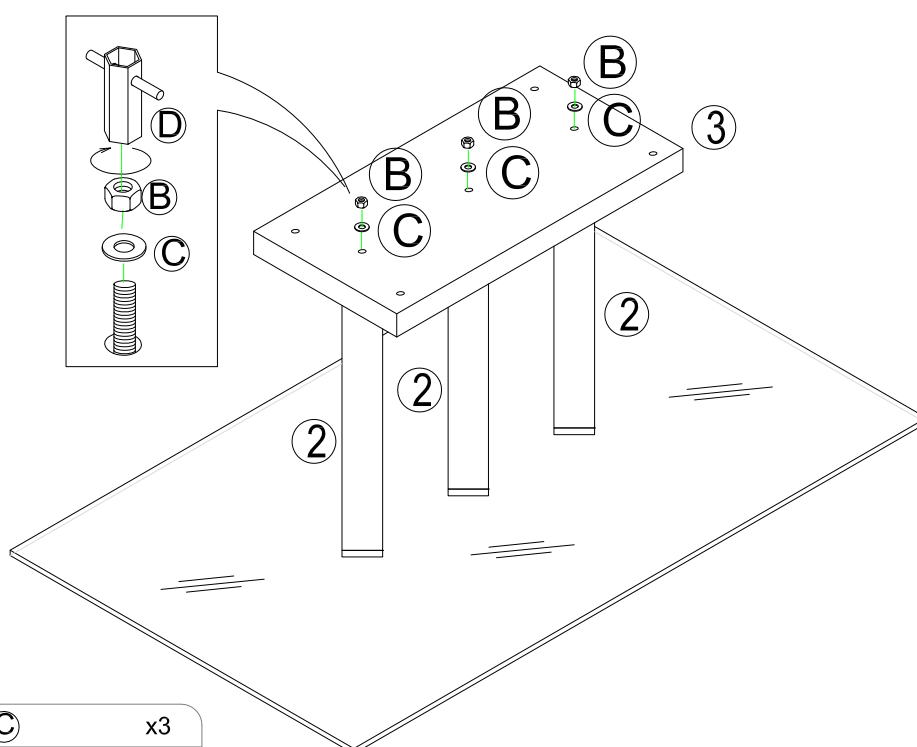

3

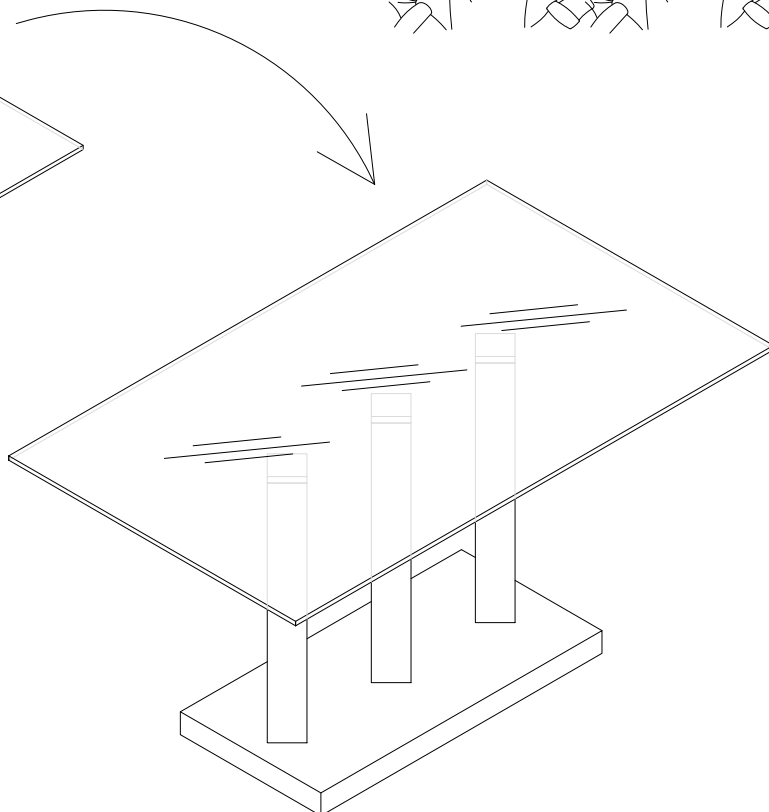
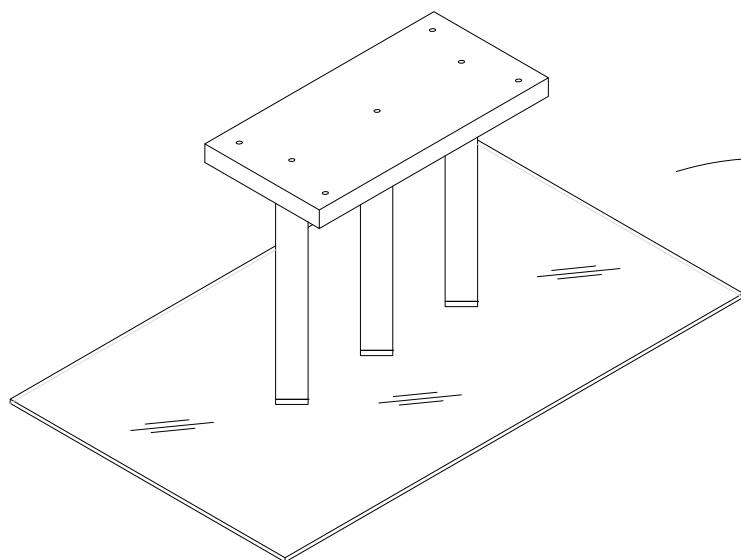

4

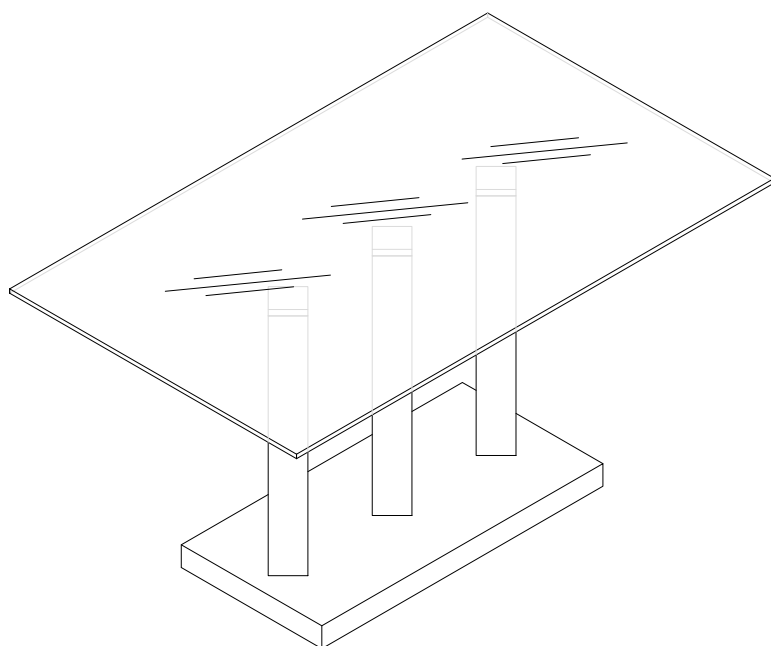

- ⒻⒼ Ne pas monter sur la table, ne pas s'asseoir sur la table.
- ⒼⒷ Do not climb on the table, do not sit on the table.
- ⒻⒺ Nicht auf den Tisch zu klettern, nicht auf den Tisch zu sitzen.
- ⒻⒶ No se suba a la mesa, no se sienta en la mesa.
- ⒻⒾ Klim niet op de tafel, niet zitten op de tafel.
- ⒻⒿ Non salire sul tavolo, non sedersi sul tavolo.
- ⒻⓉ Não subir em cima da mesa, não se sentar na mesa.
- ⒻⓁ Nie wspinać się na stole, nie siedzieć na stole.