







ASSEMBLY INSTRUCTION

TCH-S5217AR

PARTS LIST

<p>①</p>  <p>1PC</p>	<p>②</p>  <p>1PC</p>	<p>③</p>  <p>1PC</p>	<p>④</p>  <p>4PCS</p>	<p>⑤</p>  <p>6PCS</p>	<p>⑥</p>  <p>3PCS</p>
---	---	--	--	--	--

ATTENTION: IN ORDER FOR THE SCREWS TO BE SET FIRMLY , IT IS RECOMMENDED THAT THE SCREWS ARE TO BE SERVICED EVERY FIVE MONTH SIMPLY BY TIGHTENING THEN .

STEP 1

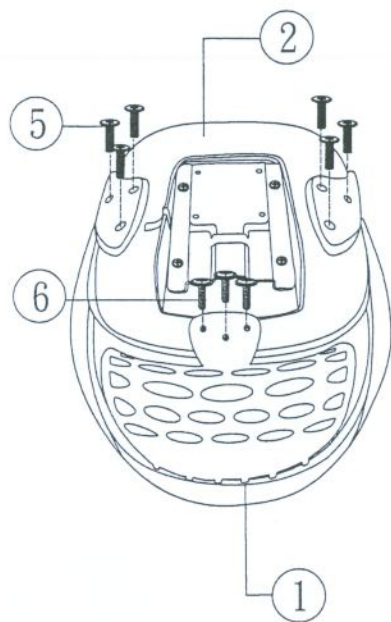

STEP 2

