

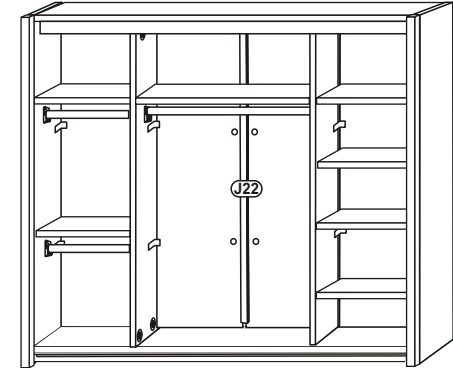

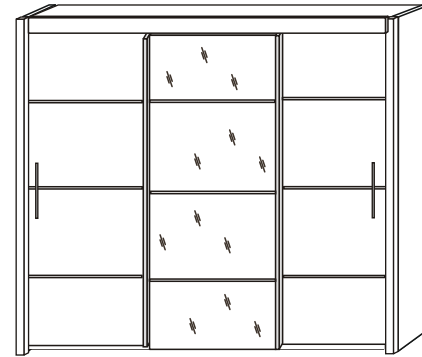

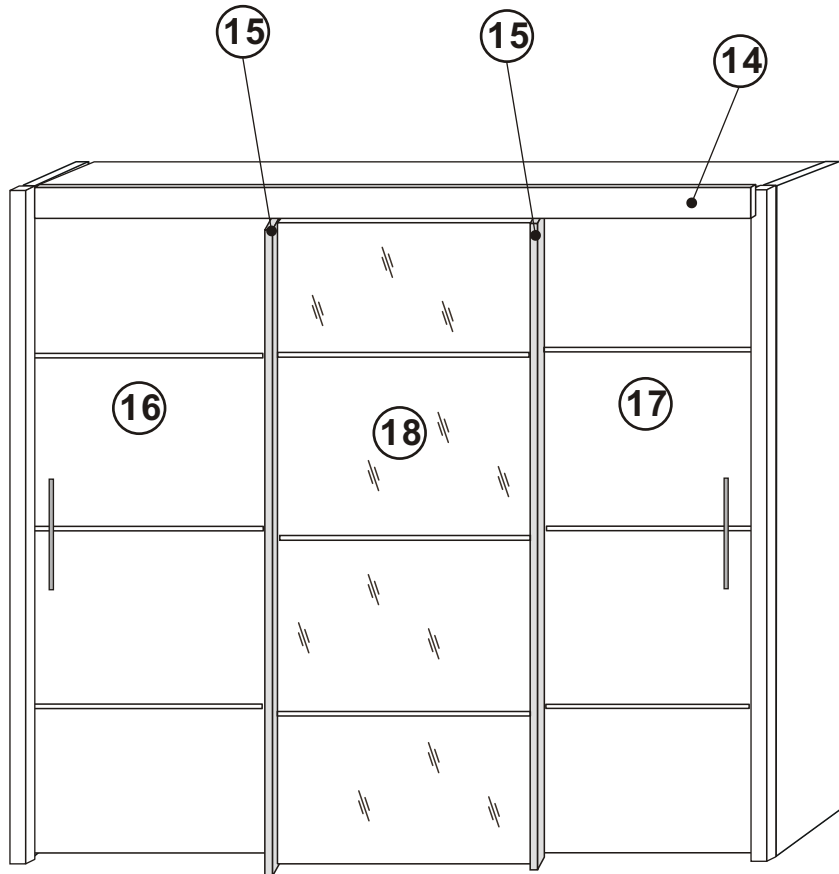

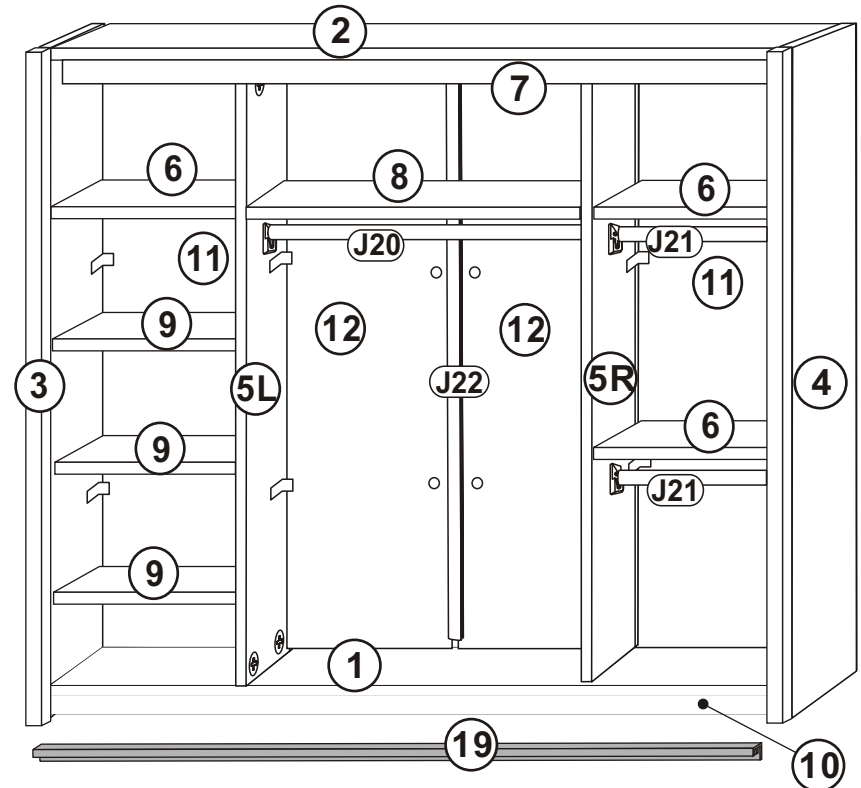

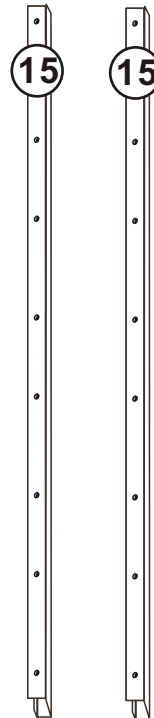















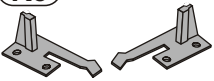
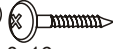
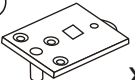

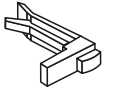
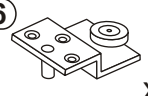

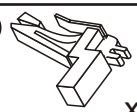
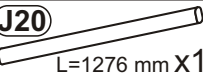
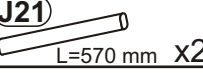
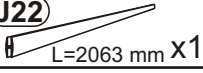
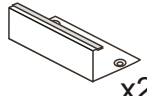

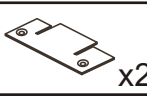



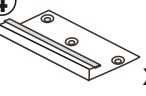

option "b"

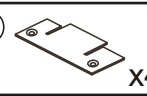
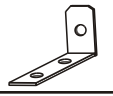

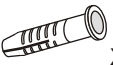
option "a"





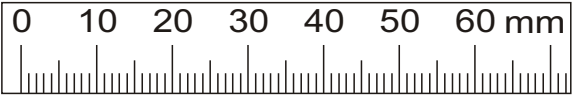

<p>1</p> <p>T6  x16</p> <p>M1  x21</p> <p>T1  x21</p> <p>B1  8x28 x18</p> <p>K1  7x50 x4</p> <p>C1  2 x2</p> <p>P16  4,2x12 x14</p> <p>M6  x14</p> <p>C2  Ø15 x16</p> <p>C3  Ø10 x6</p> <p>W1  x12</p> <p>L1  x1</p> <p>A1  M4x20 x10</p>	<p>2</p> <p>F7  x6</p> <p>S3  3,0x13 x6</p> <p>C11  2 x2</p> <p>R3  x(1+1)</p> <p>P3  4,0x16 mm x4</p>	<p>3</p> <p>E7  x4</p> <p>E2  4,0x13 x12</p> <p>R2  x2</p> <p>R1  x2</p>	<p>4</p> <p>E6  x2</p> <p>E2  4,0x13 x6</p> <p>R2  x2</p>	<p>J20  L=1276 mm X1</p> <p>J21  L=570 mm x2</p> <p>J22  L=2063 mm X1</p>	<p>5</p> <p>E3  x2</p> <p>E1  6,3x11 x4</p> <p>E5  x2</p> <p>7</p> <p>U10  L=256 x2</p> <p>A5  M4x40 x4</p> <p>S3  3,0x13 x(8+8)</p> <p>L4  x3</p> <p>L5  x2</p>	<p>6</p> <p>E4  x4</p> <p>E1  6,3x11 x8</p> <p>E5  x4</p> <p>8</p> <p>J11  x2</p> <p>P13  3,5x13 mm x4</p> <p>T13  x2</p> <p>S15  x2</p>	<p>9</p> <p>P4  3,5x13 mm X11</p> <p>G10  x10</p>
---	---	---	--	---	--	---	---

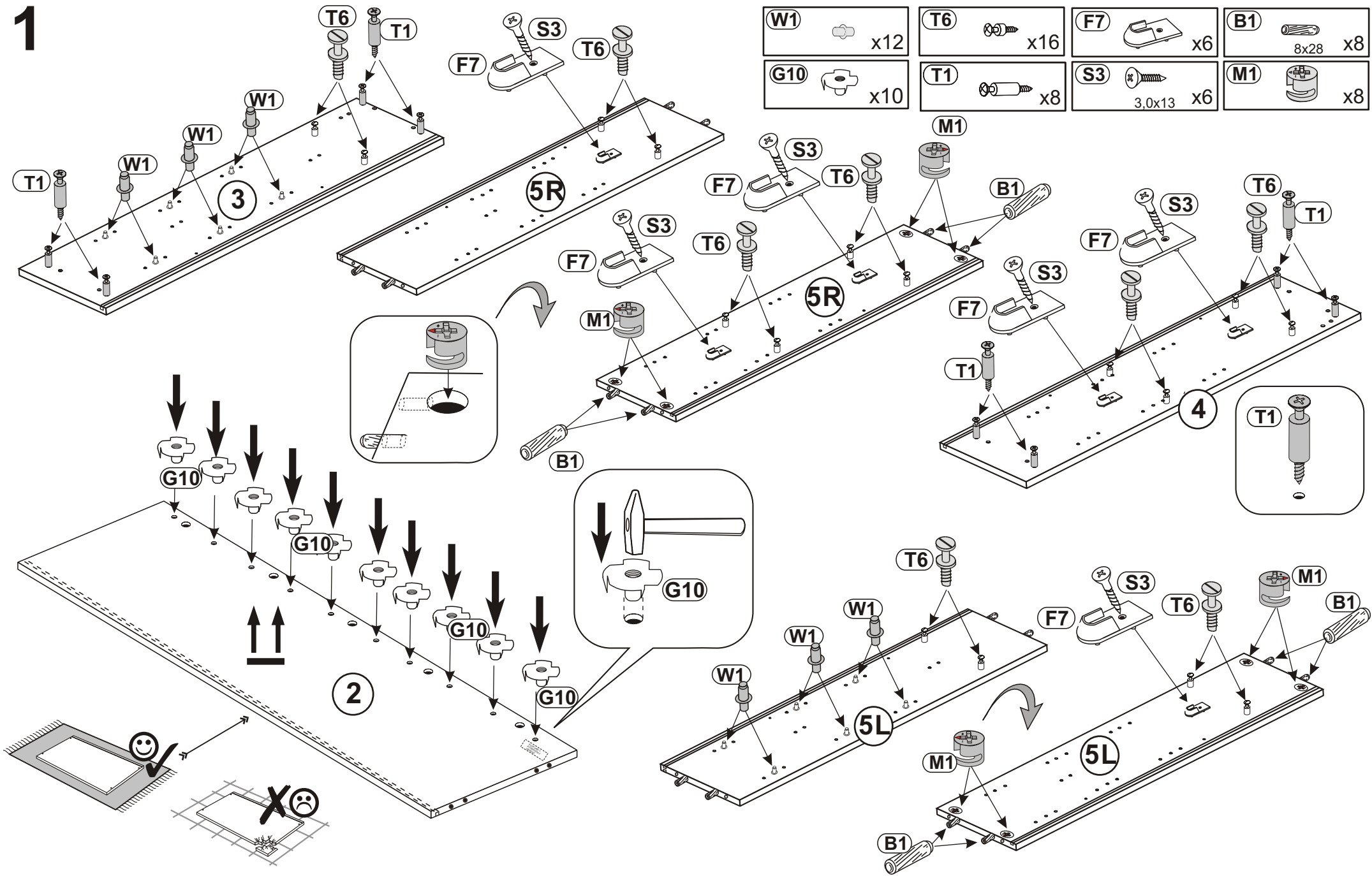

1



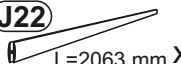

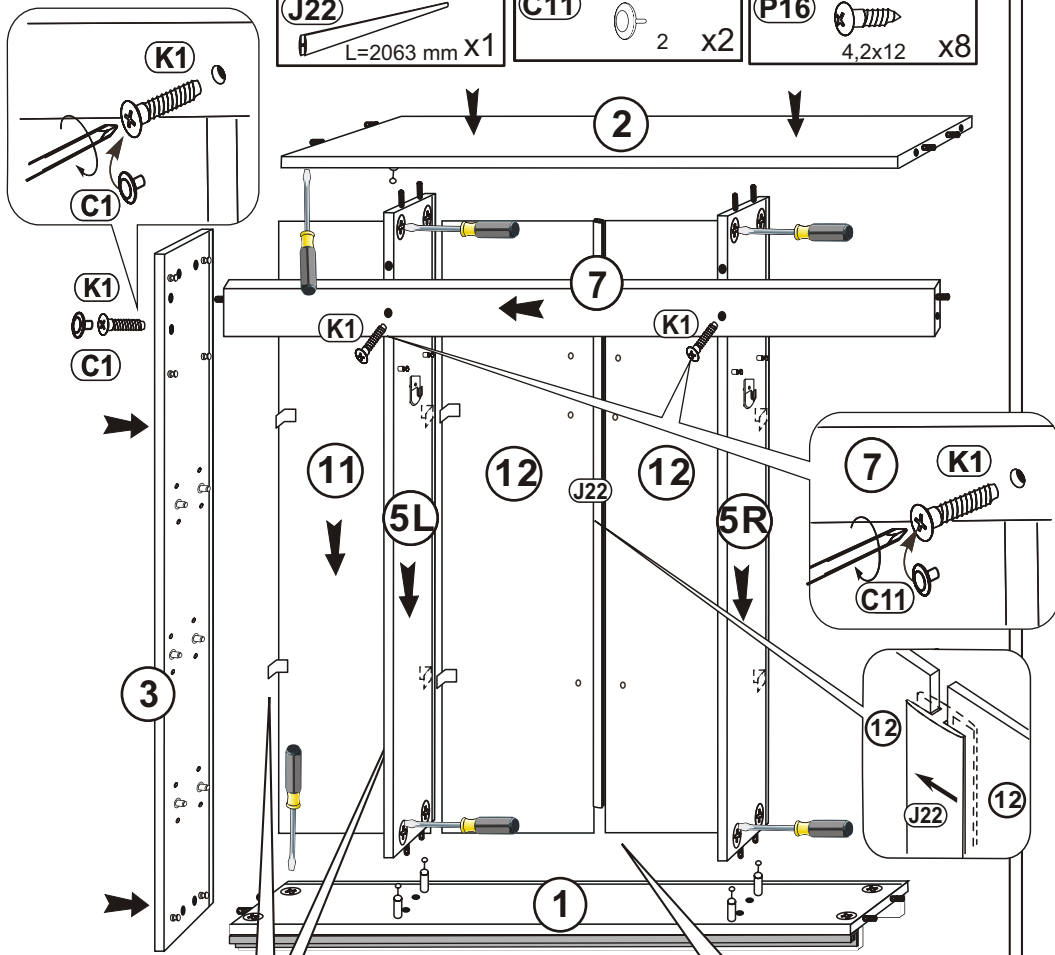

3

K1  x3	C1  2 x1	M6  x8
J22  L=2063 mm X1	C11  2 x2	P16  x8



4

K1  x1	P16  x4
C1  2 x1	M6  x4

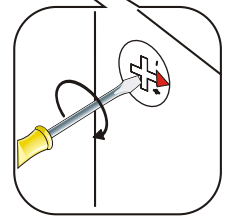
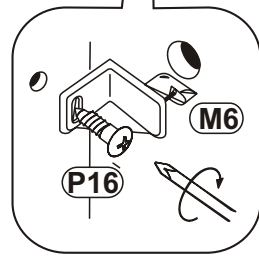
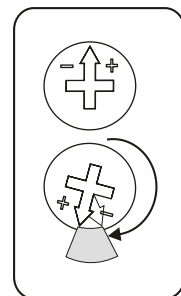
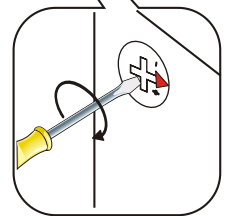
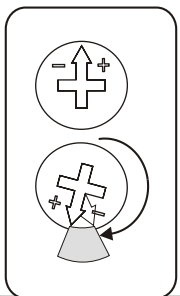
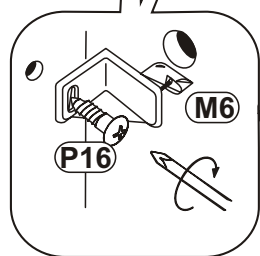
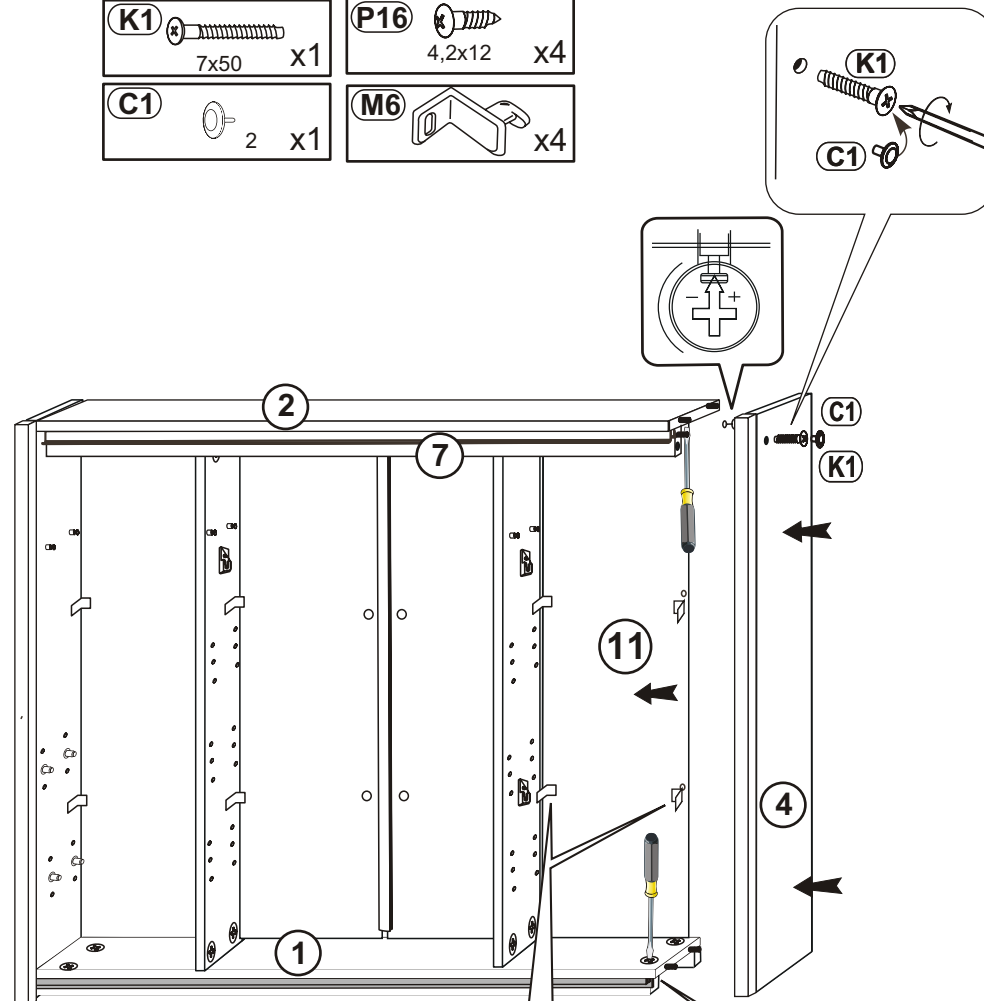

5

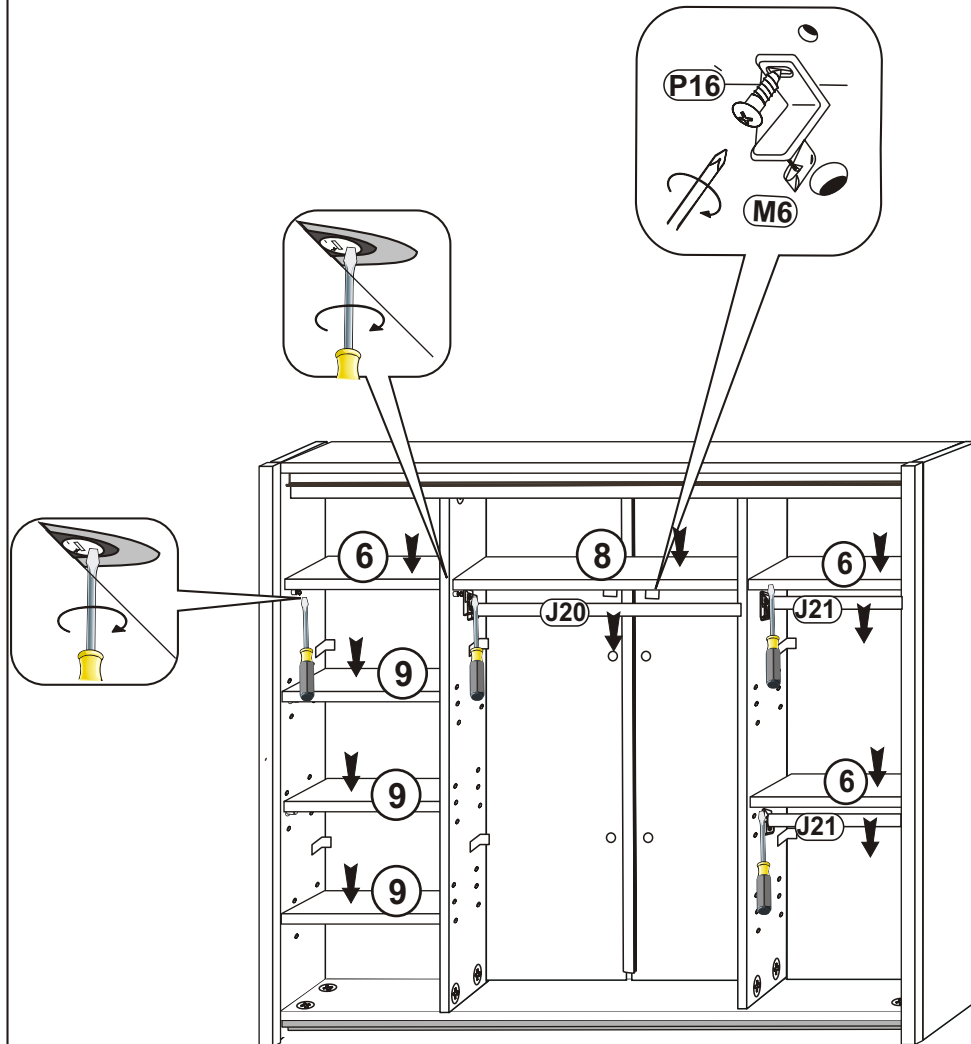
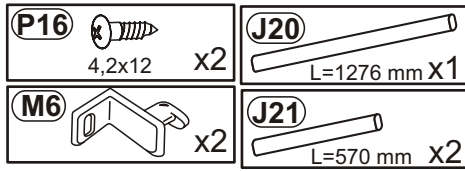

6

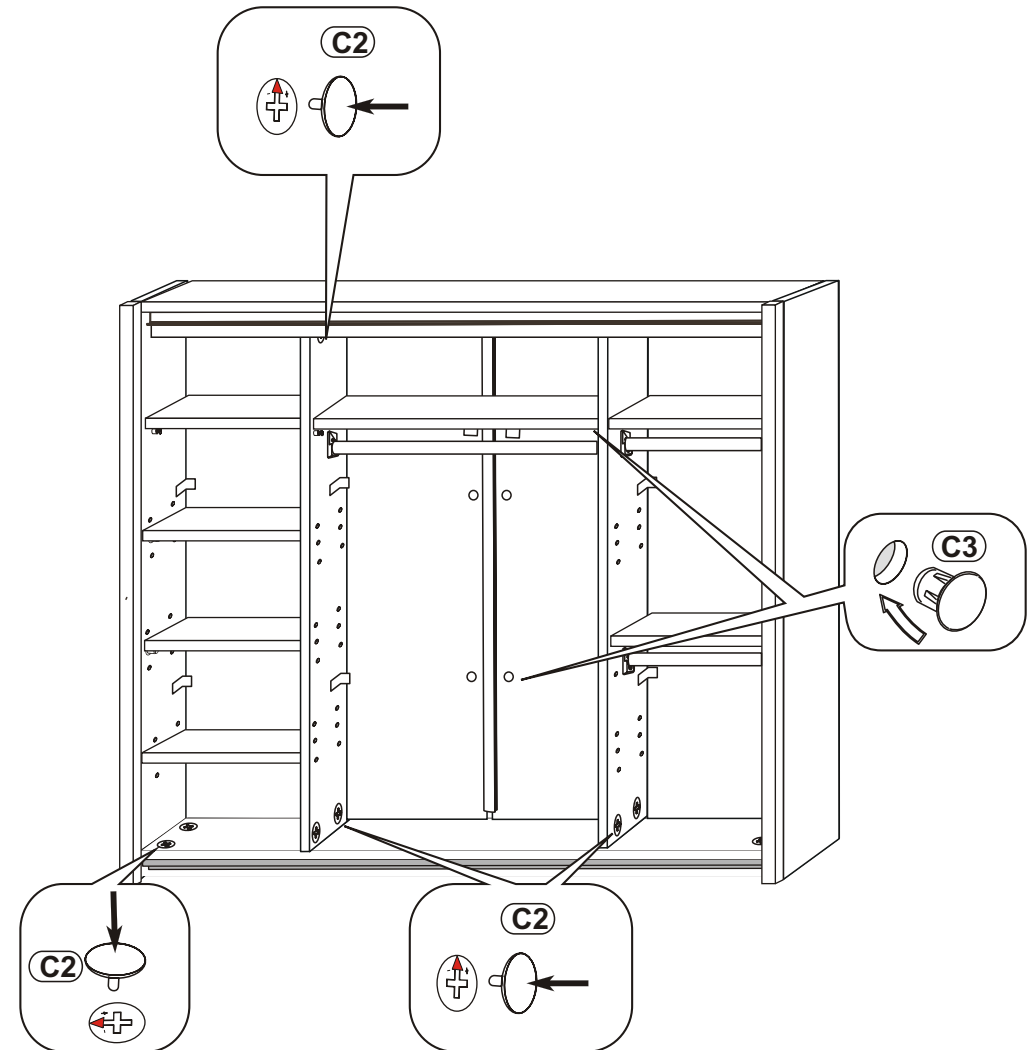
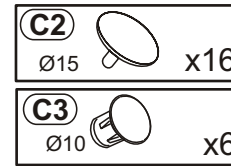

7

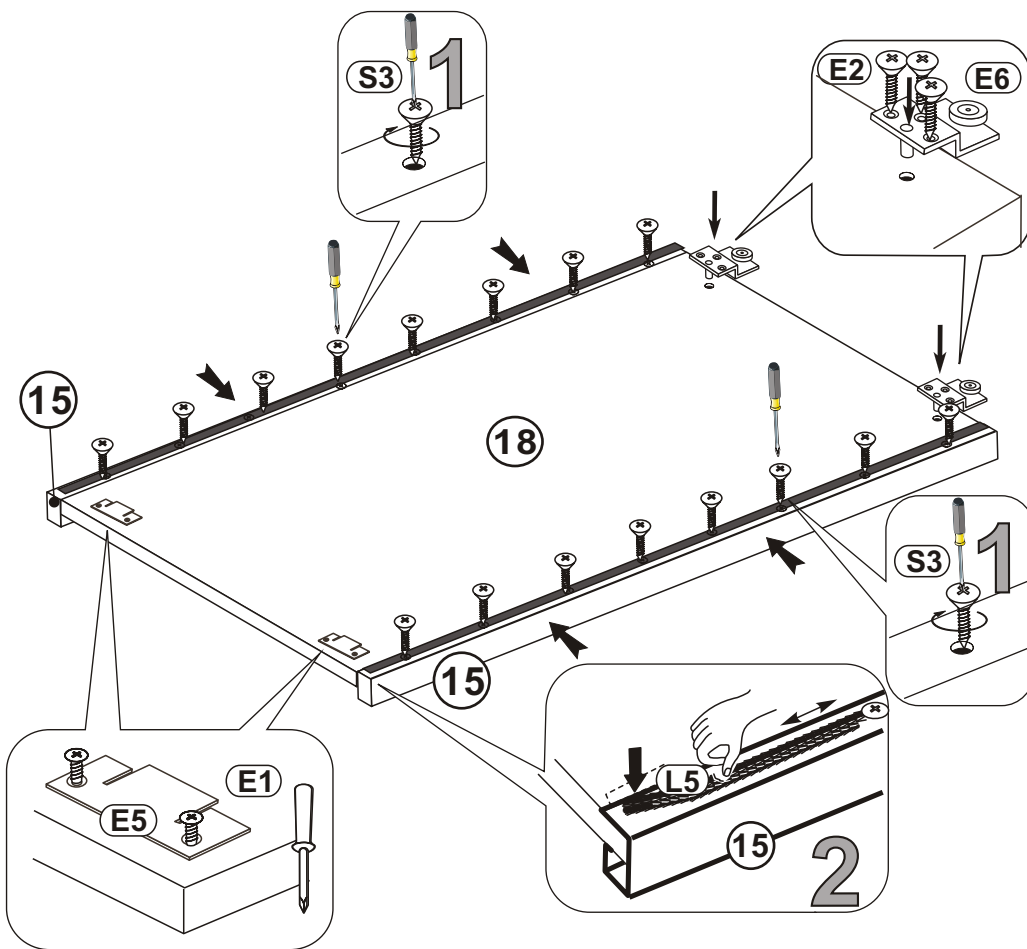
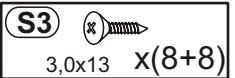
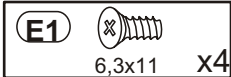
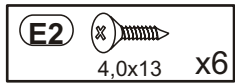
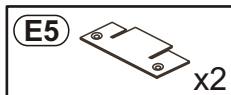
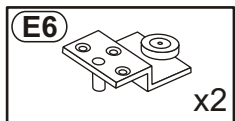

8

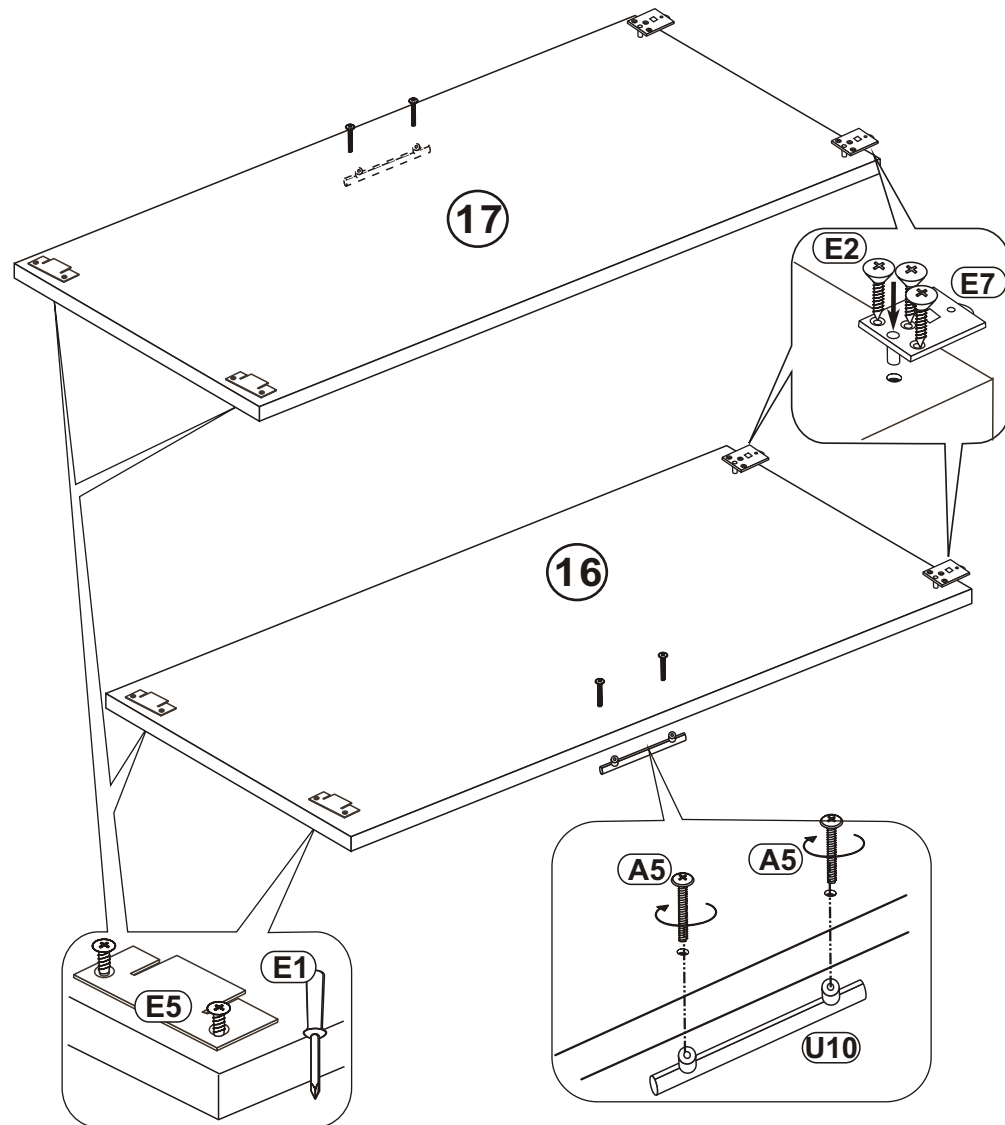
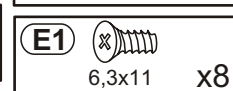
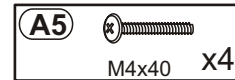
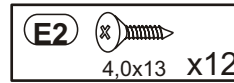
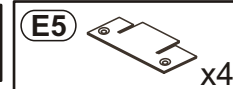
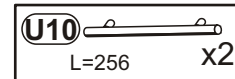
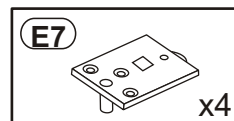

9

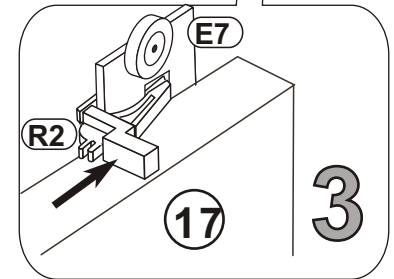
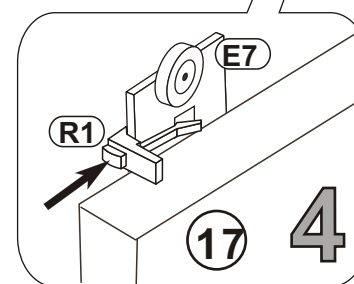
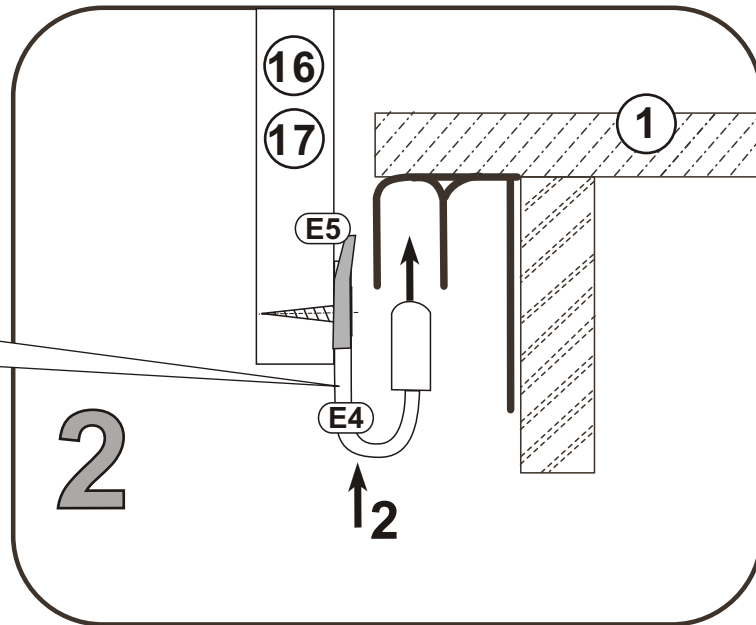
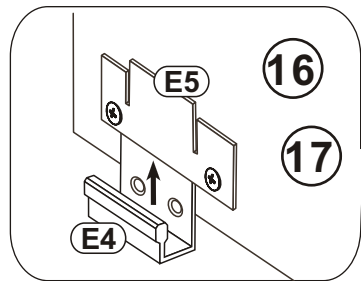
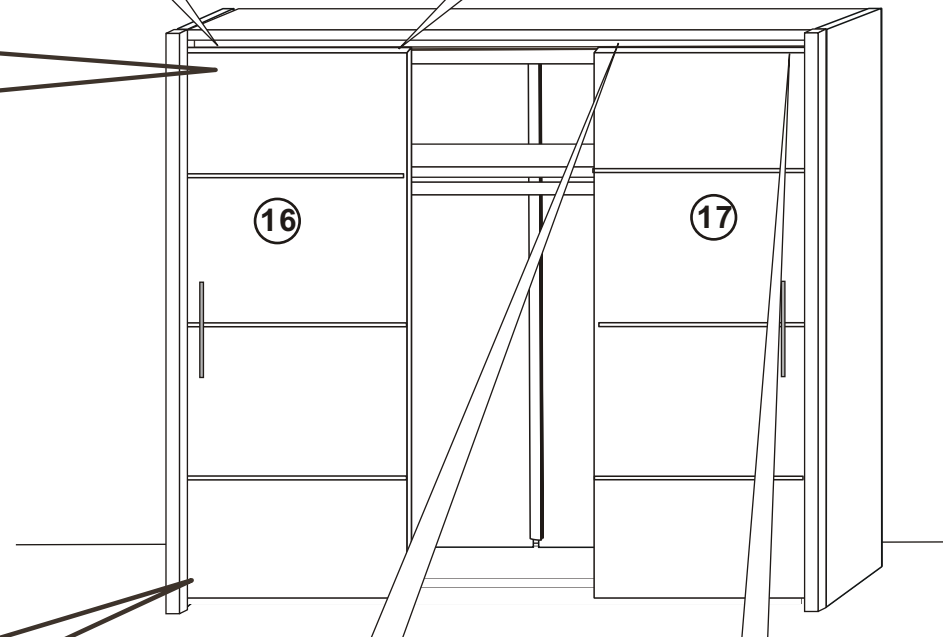
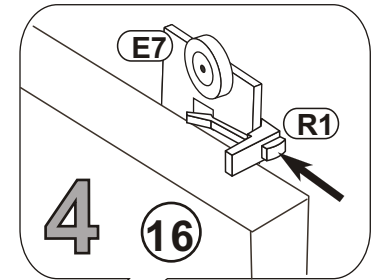
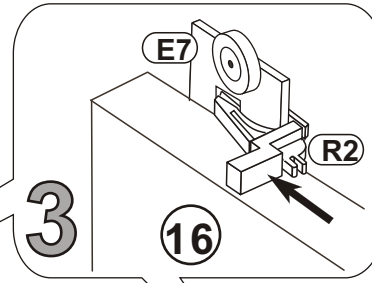
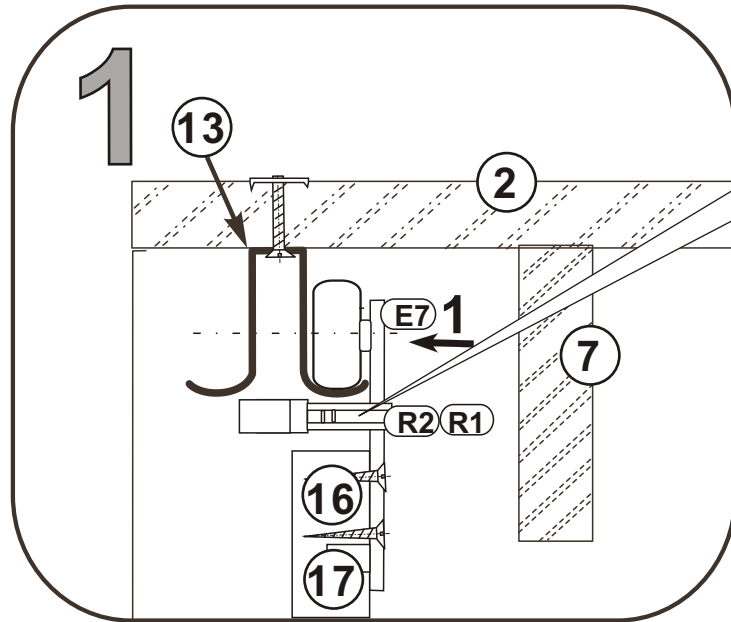
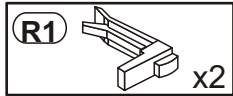
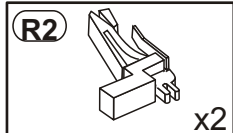
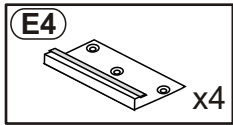

10

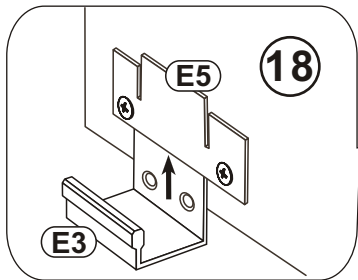
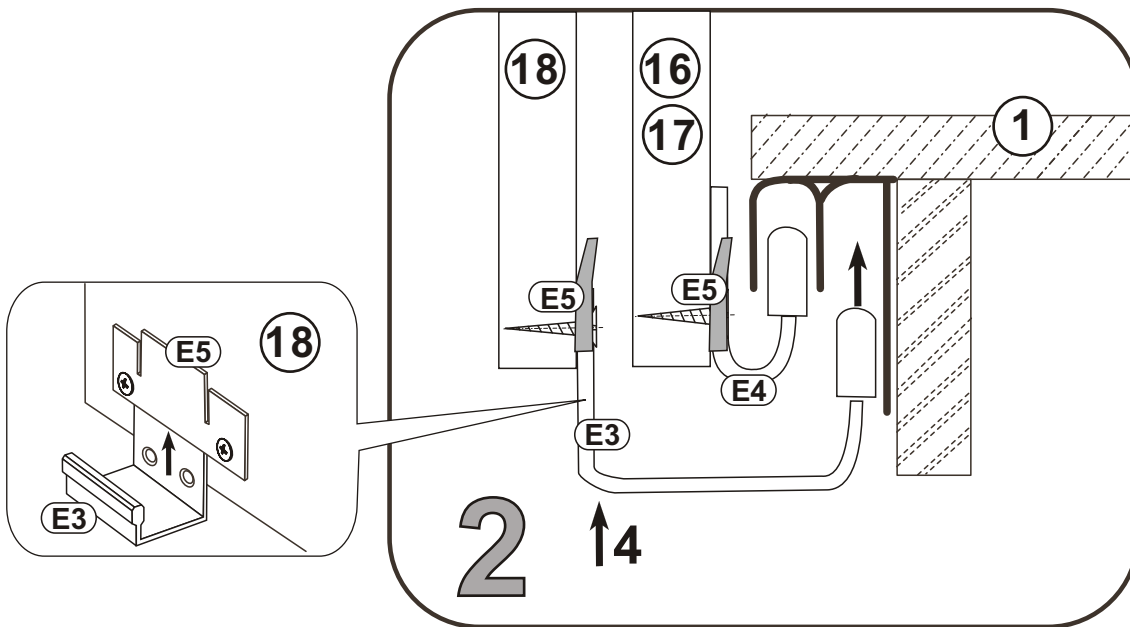
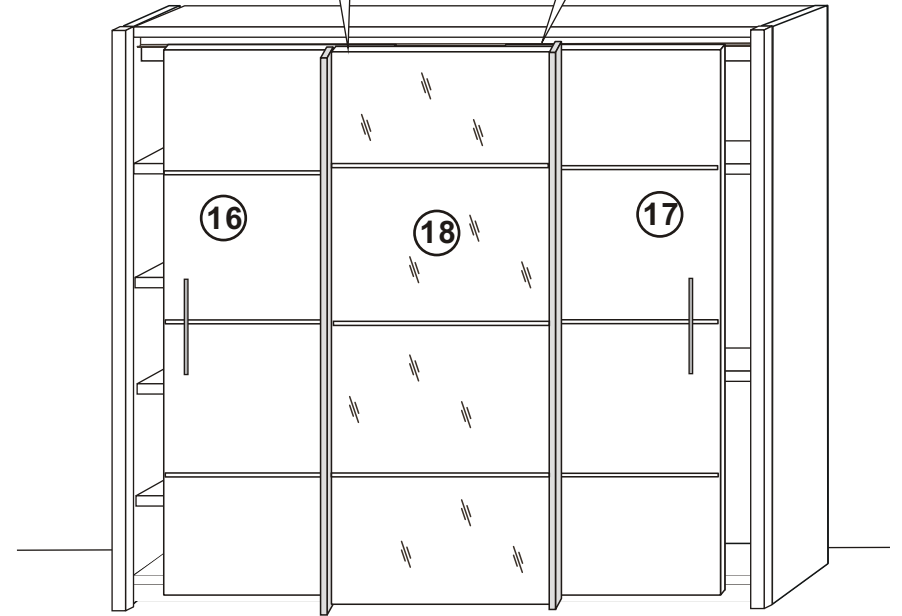
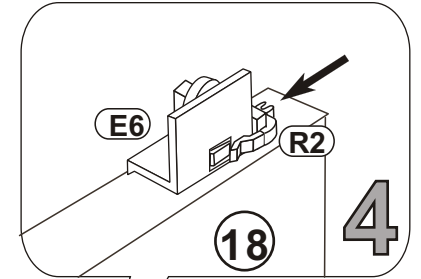
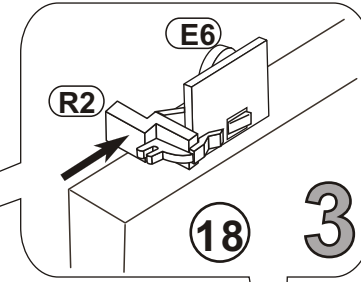
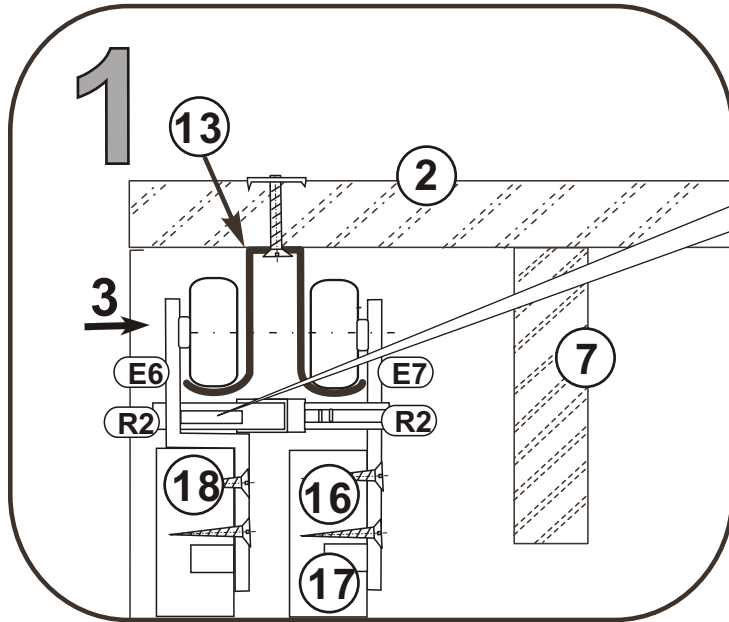
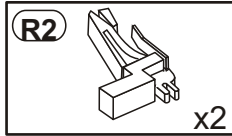
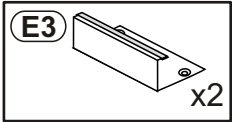

11

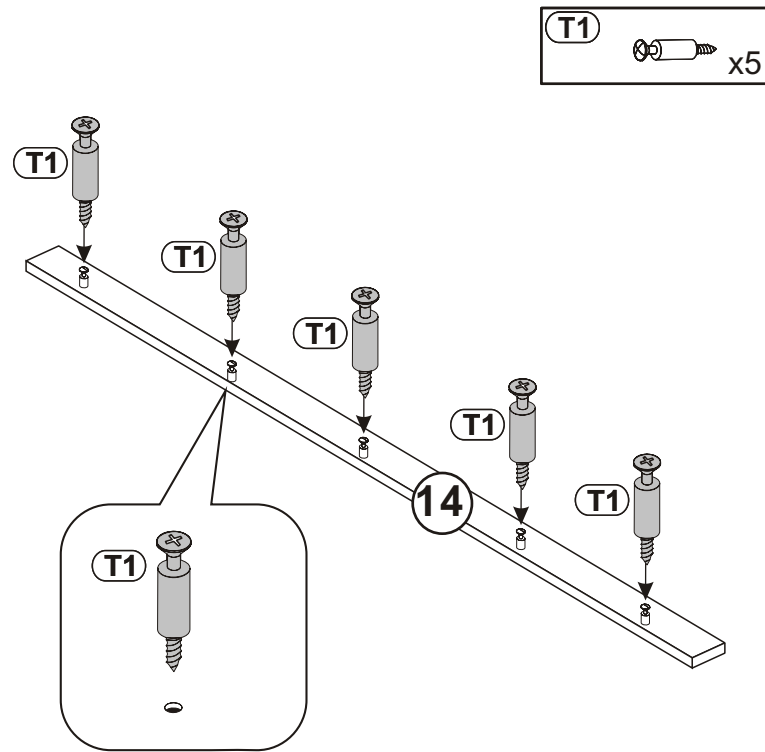

12

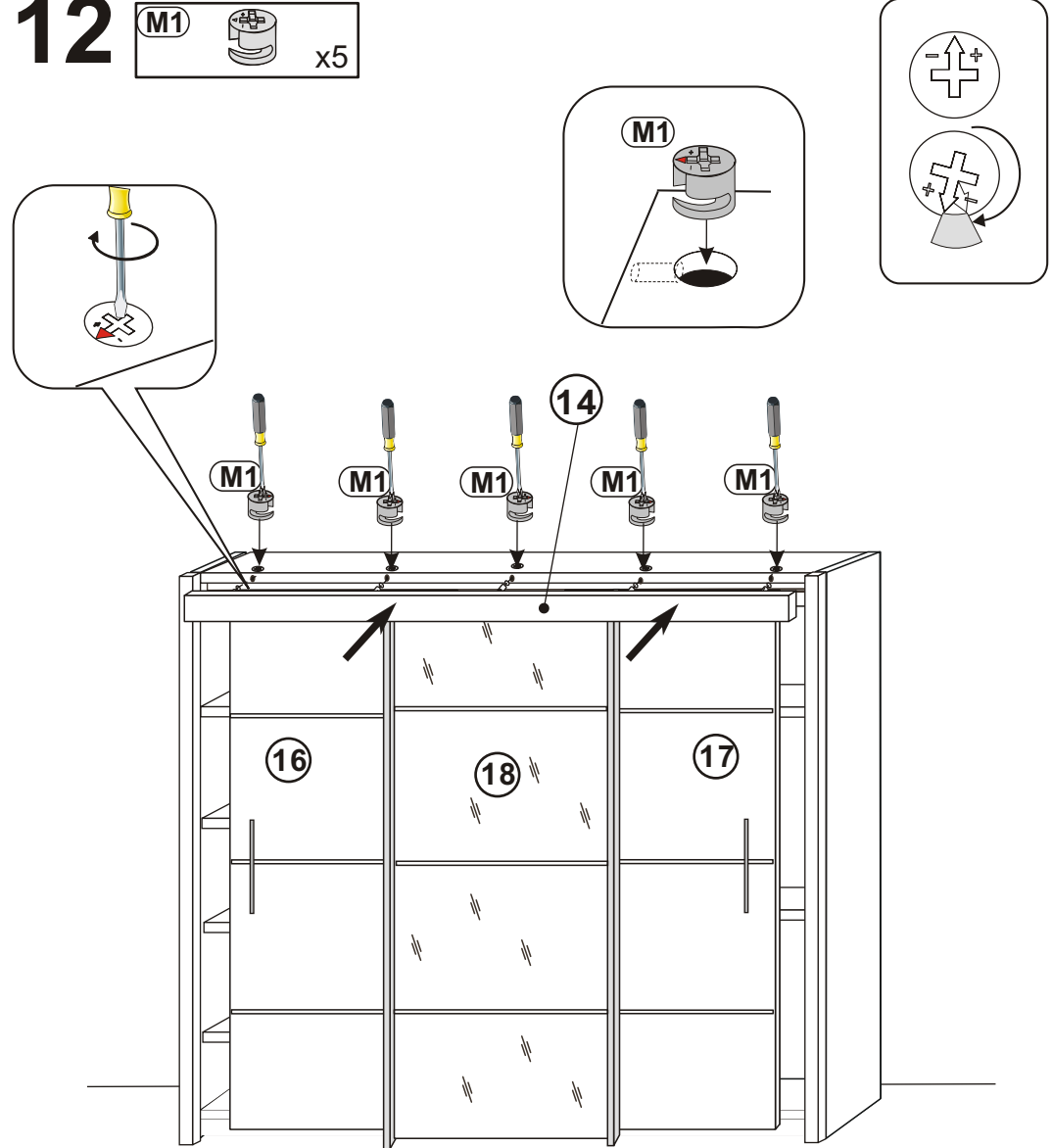

13

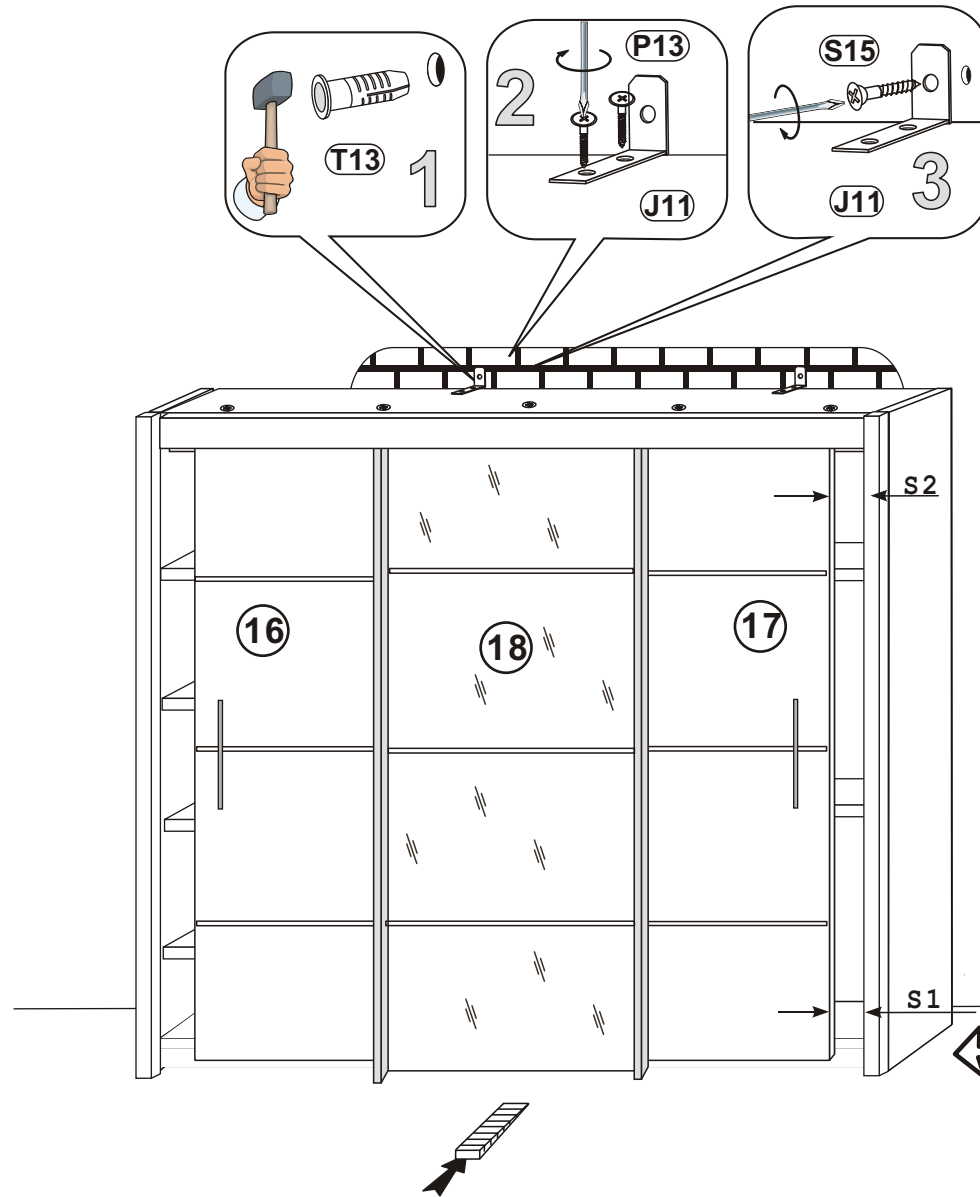

- (PL)** Załączone kołki do zawieszania bryty, do stosowania wyłącznie do ścian betonowych, do innych ścian należy odpowiednie dokupić.
- (GB)** Attached dowels to hang up unit are for concrete walls only. For other types of walls, appropriate dowels must be purchased
- (D)** Die beigelegten Dübel zum Aufhängen des Elements dürfen nur bei Betonwänden eingesetzt werden, bei anderen Wandarten müssen entsprechende Dübel zugekauft werden.
- (F)** Les chevilles jointes, pour pendre l'élément, sont pour les murs bétonnés exclusivement; pour autres murs il faut acheter chevilles adéquates

