













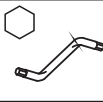
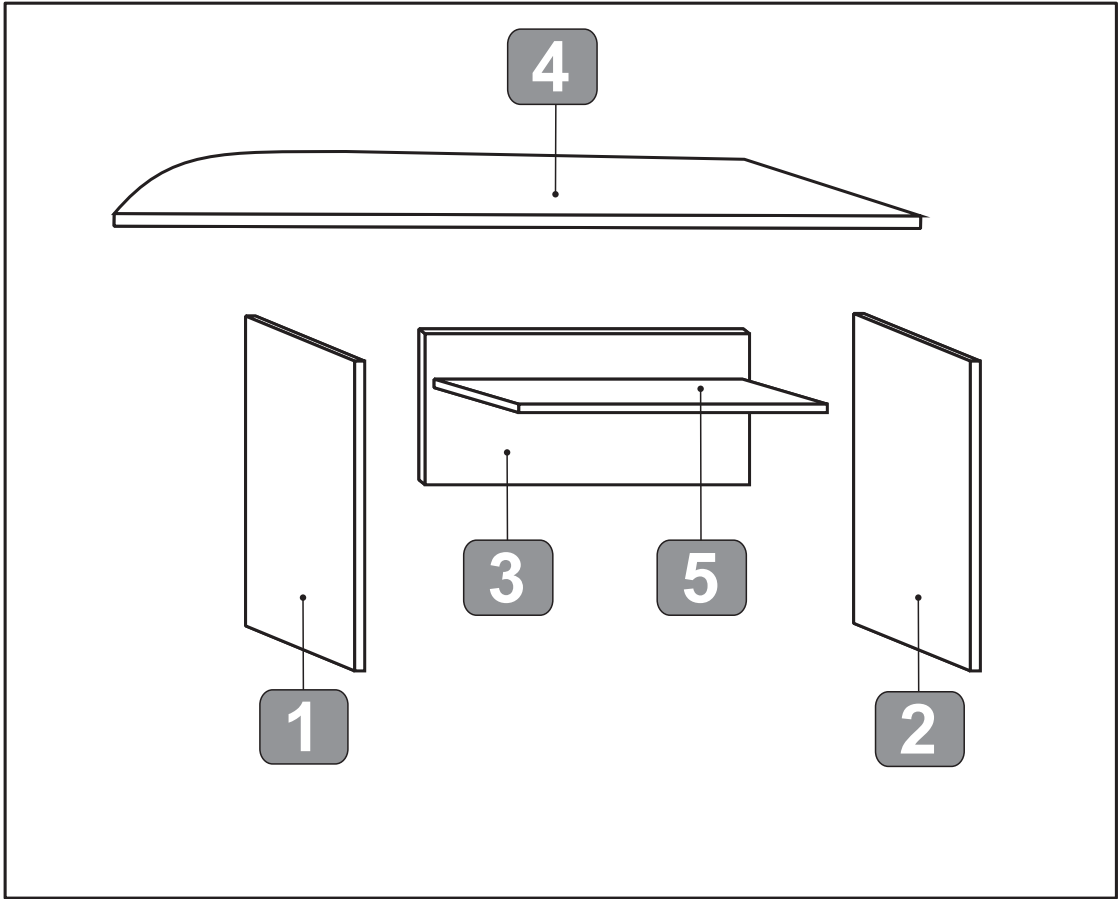

## MAG EURO

**03 -- 50/26**

 <b>35 MIN</b>	 <b>x2</b>			
				

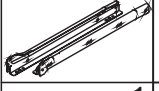

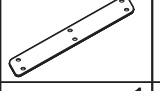
*Avant de commencer, se reporter aux conseils de montage en annexe*  
  
**Before starting, refer to the assembling advice in annex**  
  
*Avanti di cominciare, riportate agli consigli di montaggio*  
  
**Vor die montage, bitte beiliegende anweisungen folgen**  
  
*Antes de començar, adiar se aos conselhos de montagem em anexo*  
  
**Antes de empezar consulte los consejos para el montaje**  
  
*Przed rozpoczęciem zapoznać się załączoną instrukcją montaży*

<b>Bag 2</b>	 a 8	 b 8	 c 4	<b>Bag 3</b>	 b 4	 c 4	<b>Bag 4</b>	 c 4
<b>Bag 6</b>	 a 1	 b 3,5x13 10	<b>Bag 11</b>	 a 1	 b 6	 c M6x12 6		

