

MONTAGEANLEITUNG INSTRUKCJA MONTAŻOWA

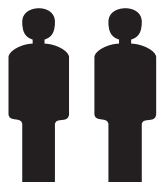

2 Personen
2 Osoby

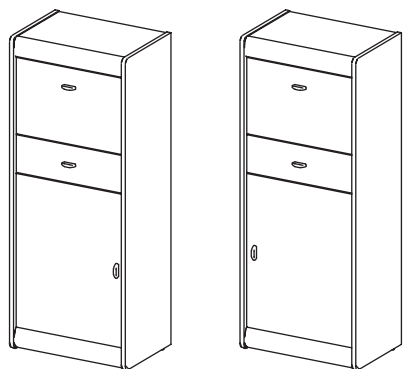
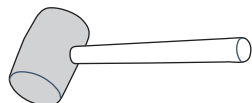
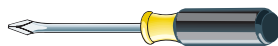
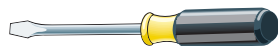
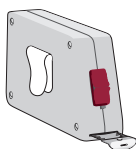

TYPE "L" TYPE "R"

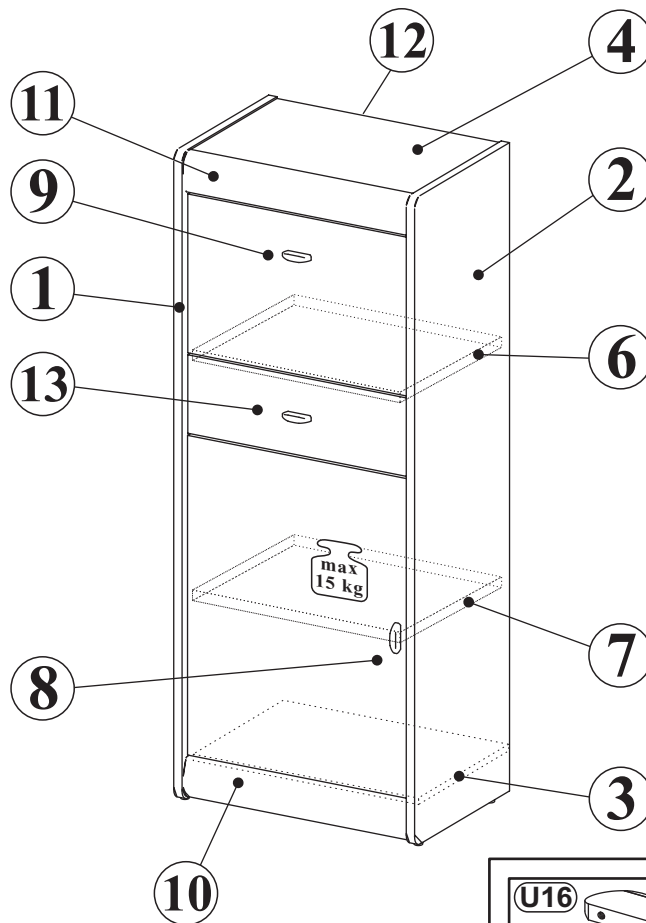

**MONTOWAĆ
 NA ROZŁOŻONYM KARTONIE!**

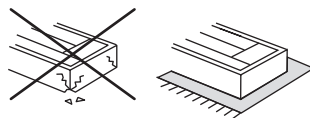

















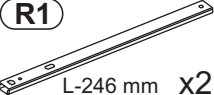





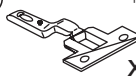
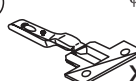

**Wskazówka dotycząca
 pielęgnacji!**

Proszę czyścić tylko suchą
 lub lekko wilgotną szmatką do kurzu.
 Nie używać żadnych środków szorstkich!
 Maksymalne obciążenie półek w kg:

| Stärke/Gr. | Spanplatte/Płyta | | |
|--------------|------------------|----|----|
| Länge/Dł. mm | 15 | 18 | 22 |
| 0<400 | | | |
| 401<600 | 40 | 40 | 40 |
| 601<800 | 24 | | |
| 801<1000 | 15 | 30 | |

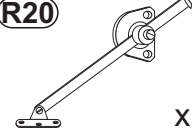

- F15**  x4
- L10**  x2
- F6**  x2
- P13**  3,5x13 mm x4
- J44**  x1
- P13**  3,5x13 x1
- G22**  φ18 x2
- T13**  φ8 x1
- S15**  4x45 x1
- R1**  L-246 mm x2
- E4**  6,0x8,0 x4
- A1**  M4x9 mm x2
- J23**  x4
- B1**  φ 8x28 x16
- M1**  x16
- T1**  x16
- C2**  x16
- W1**  x6
- P33**  x41
- Y1**  φ26 KR15 x2
- Y2**  φ26 KR8Z x2
- Y5**  H2 x4
- E1**  6,3x13 x8
- S8**  4x13 x8
- R20**  x1
- S3**  3,5x13 x6

1

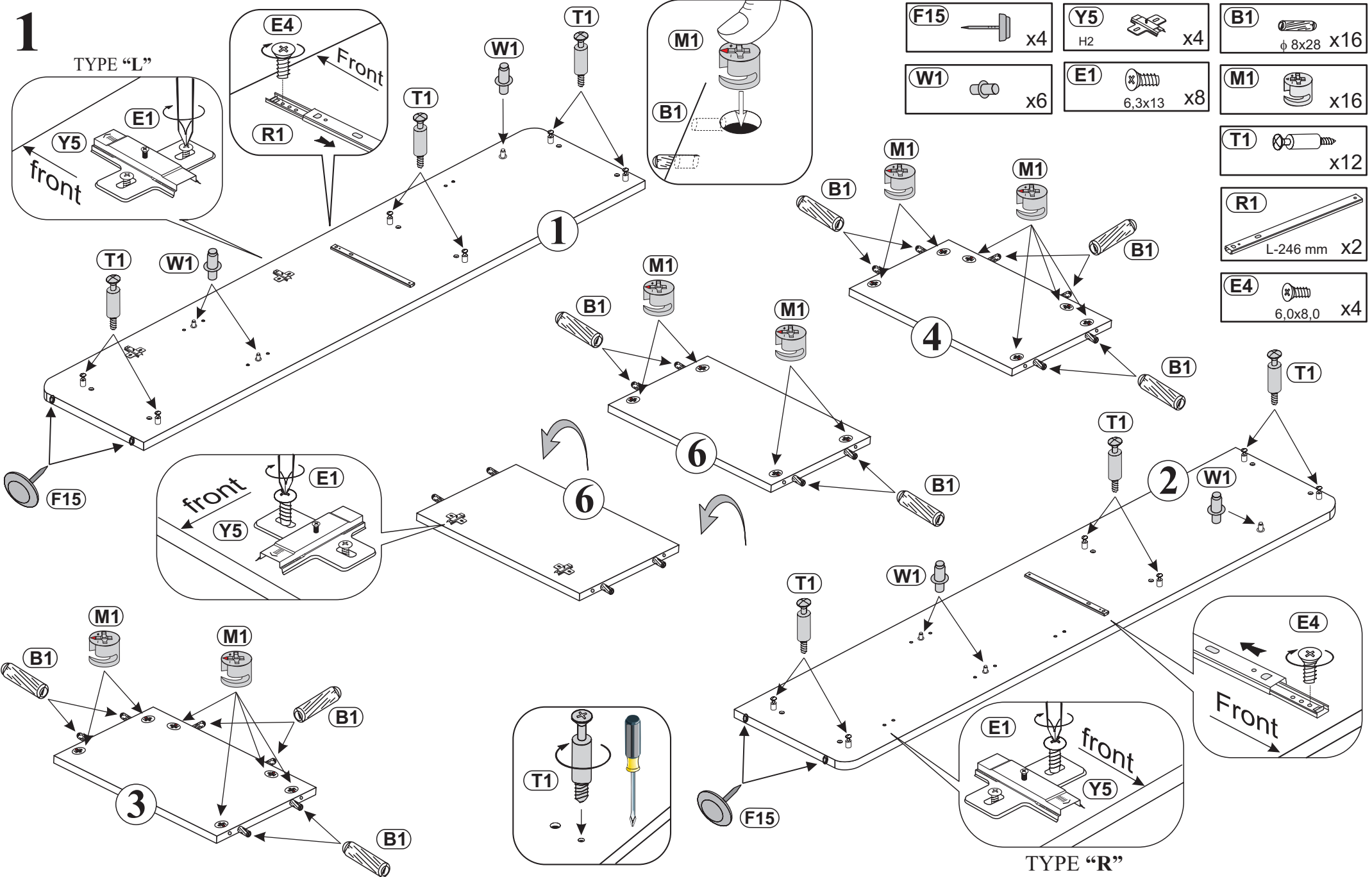

F15 x4

Y5 x4
 H2

B1 x16
 ϕ 8x28

W1 x6

E1 x8
 6,3x13

M1 x16

T1 x12

R1 x2
 L-246 mm

E4 x4
 6,0x8,0

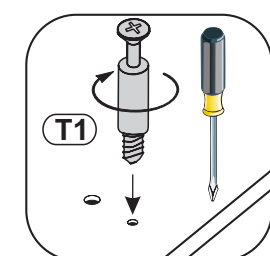
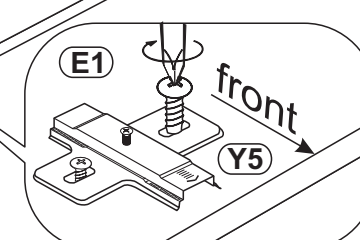
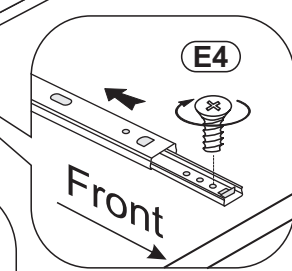
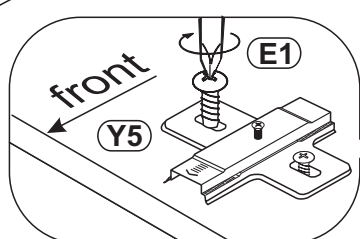
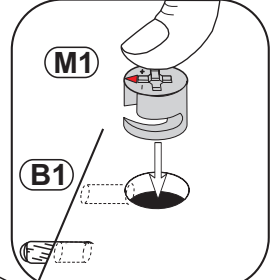
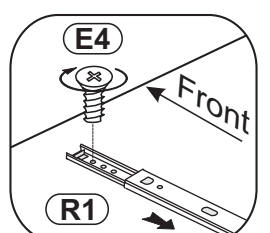
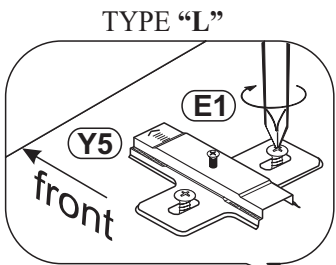

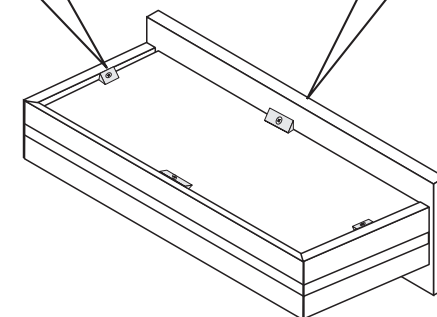
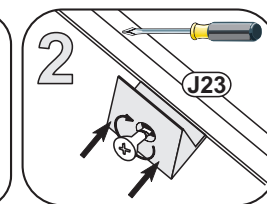
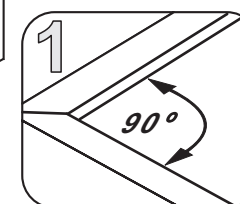
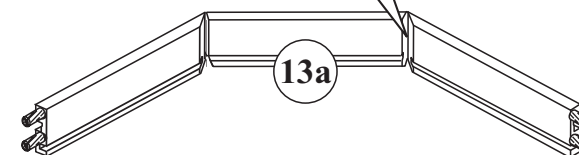
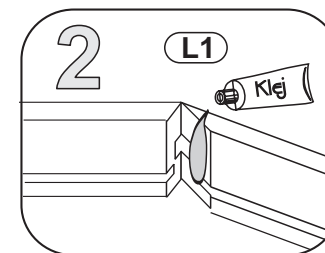
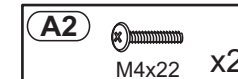
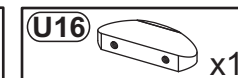
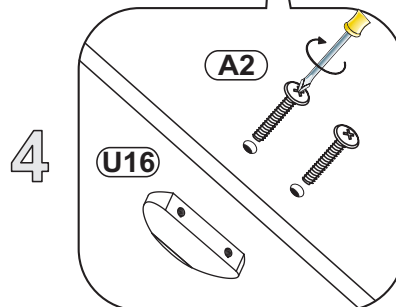
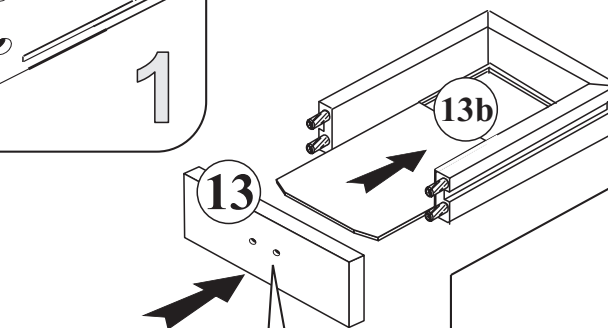
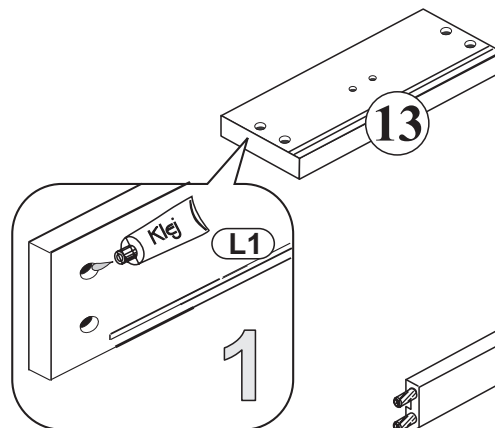
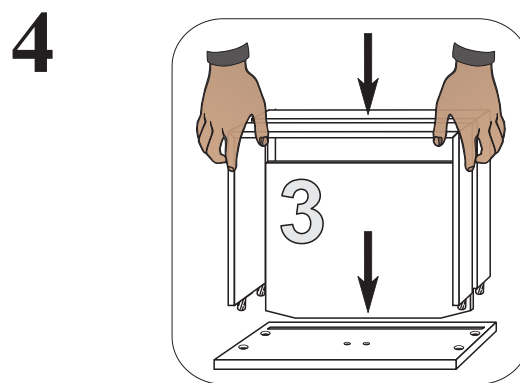
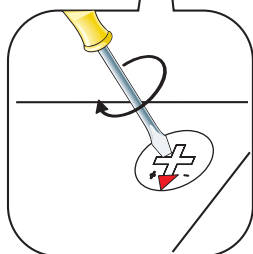
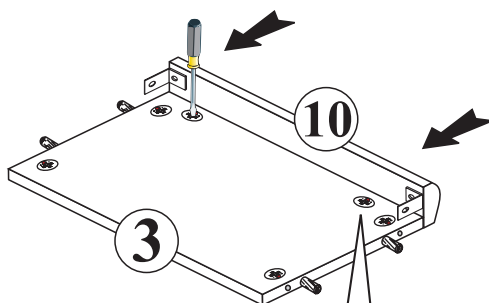
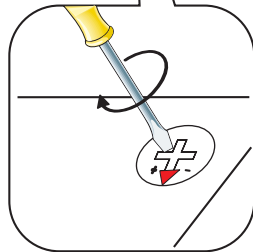
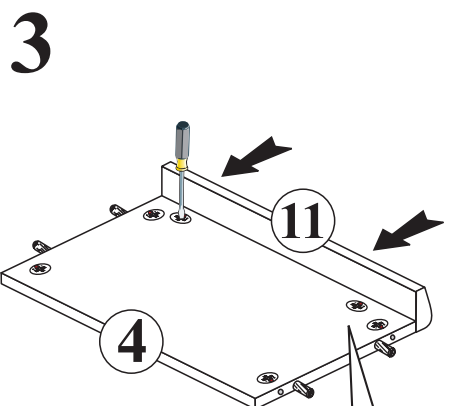
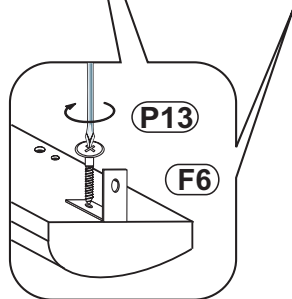
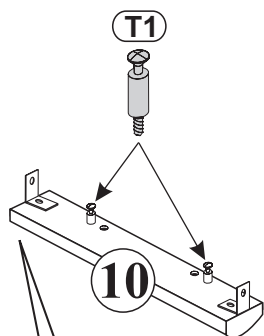
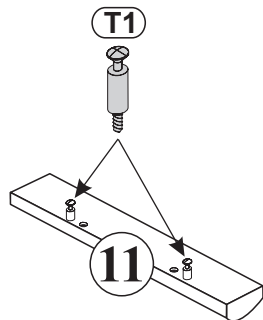
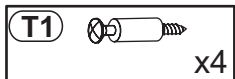
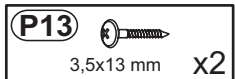

6

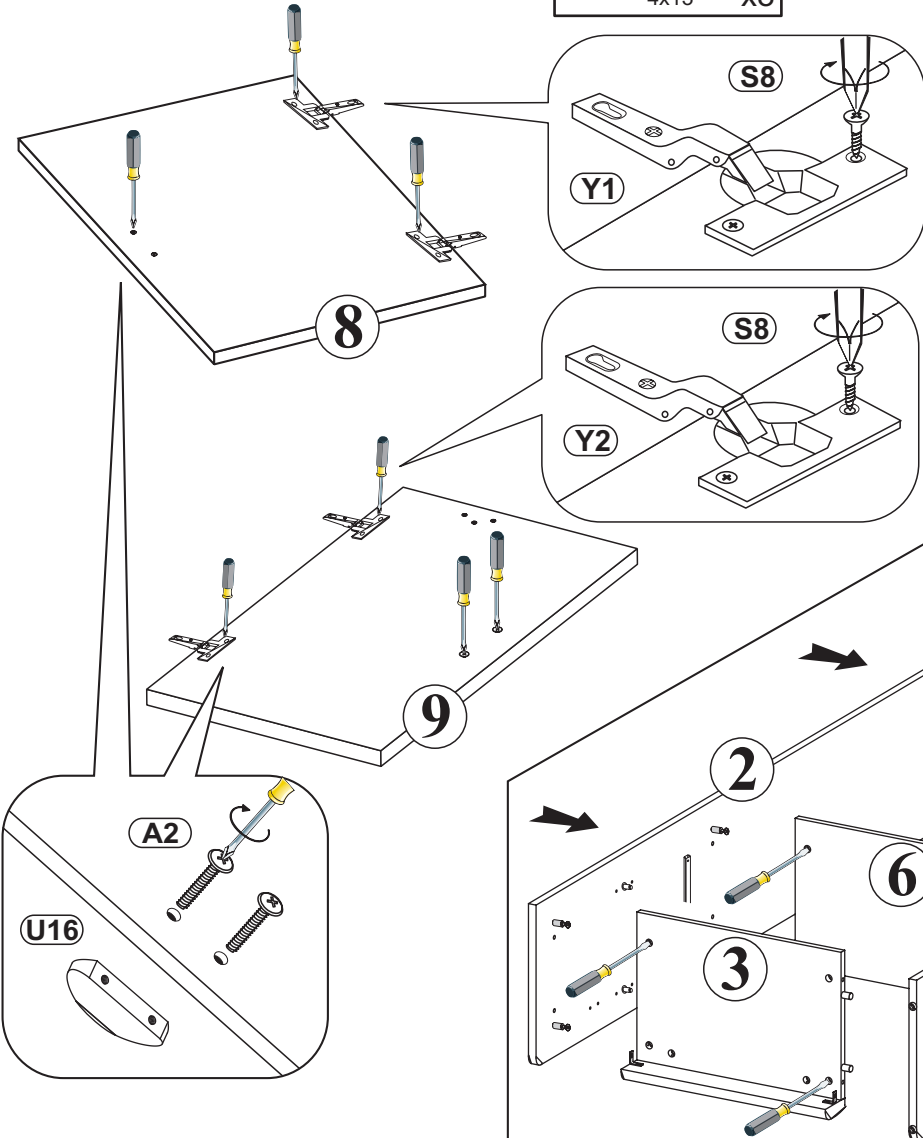
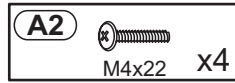
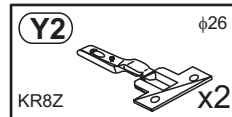
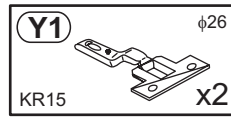
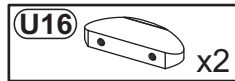

7

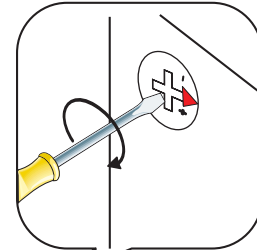
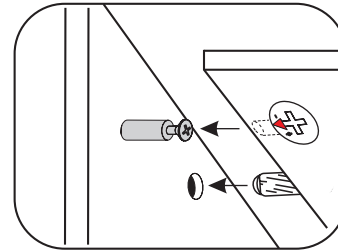

8

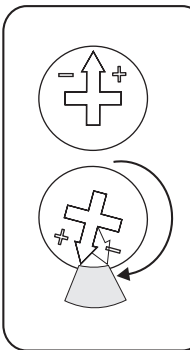
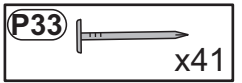
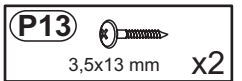
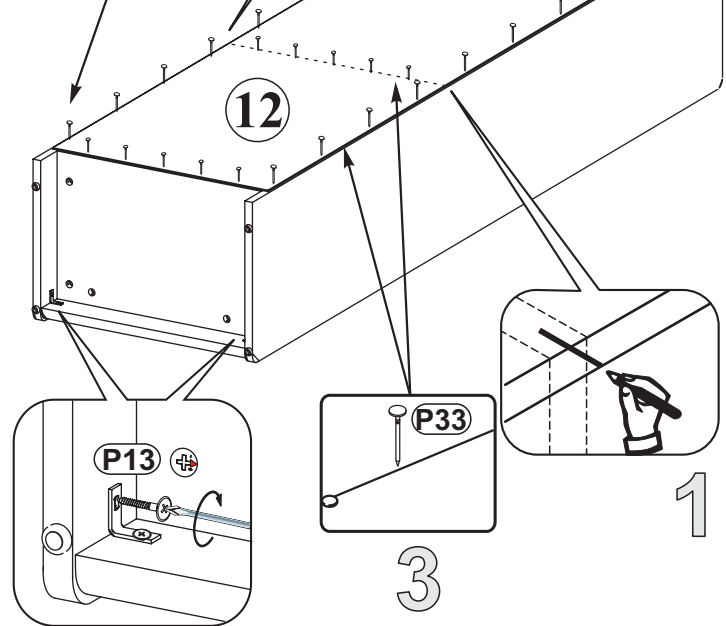
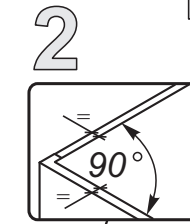

9

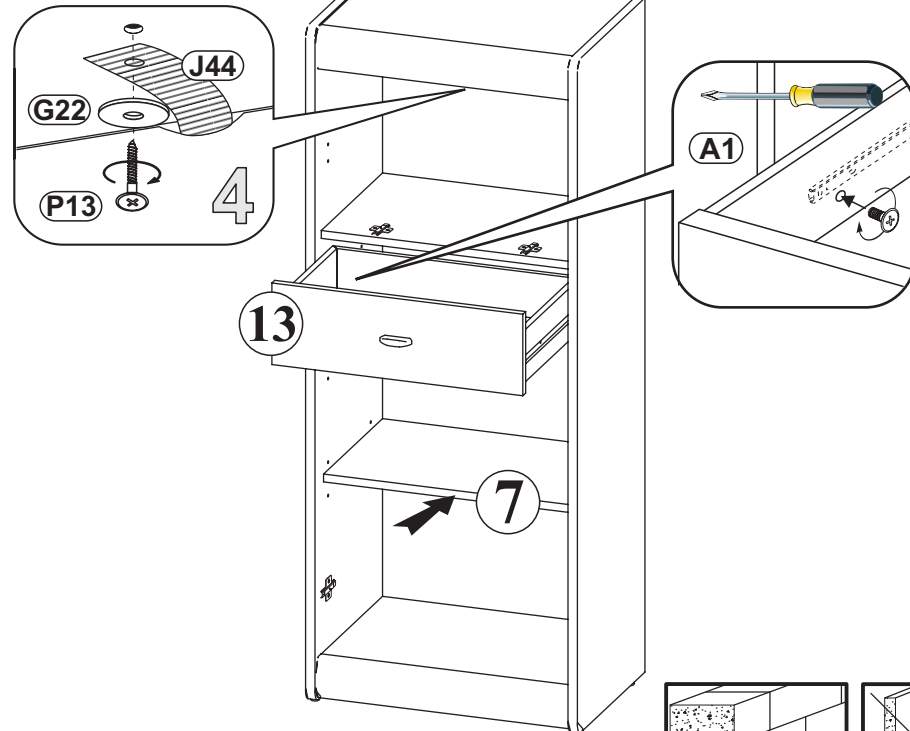
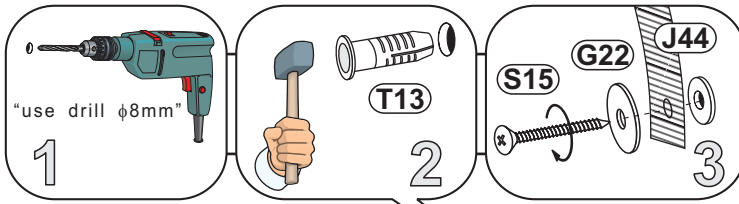
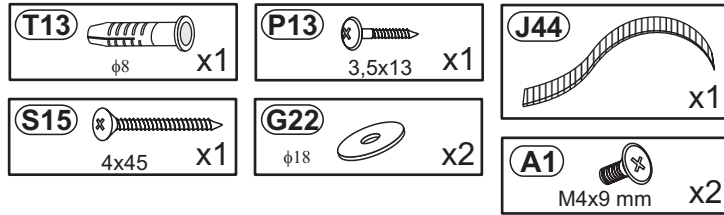

10

