

980818

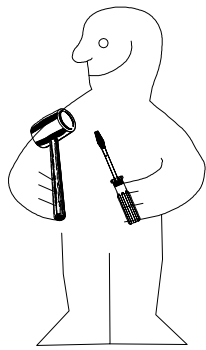

1.



2.

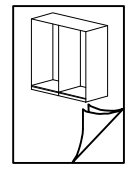
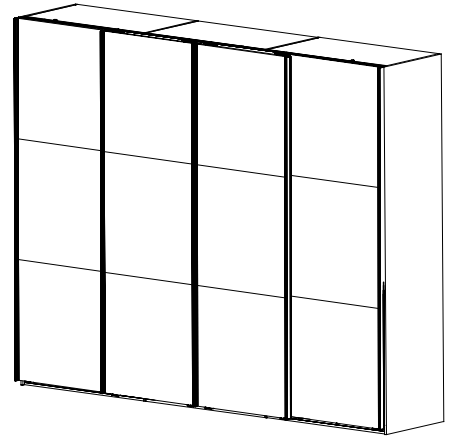
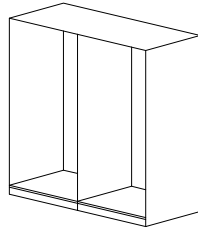

MR SHSP 300 4trg

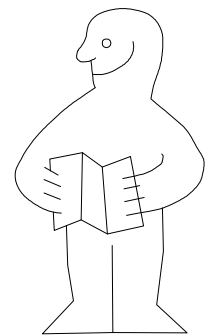
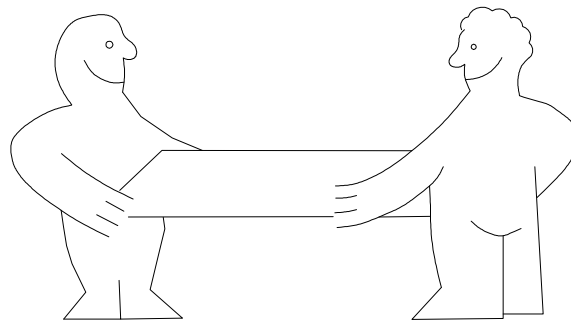
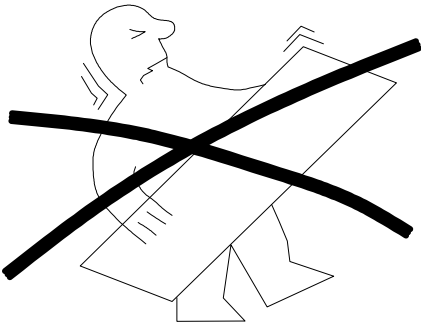

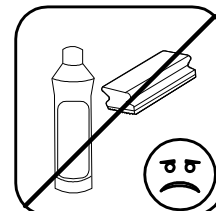
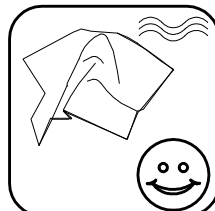
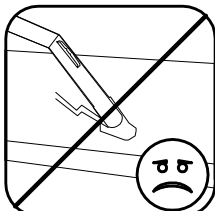
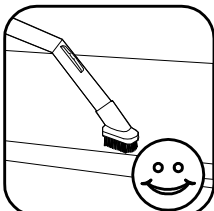
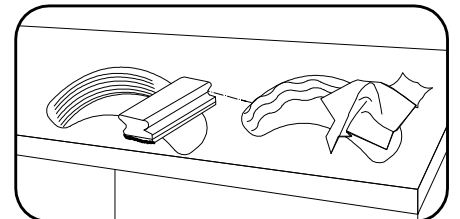
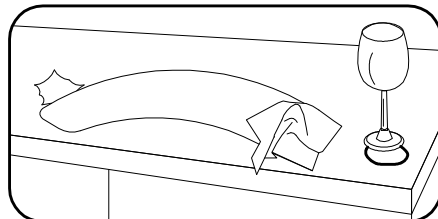
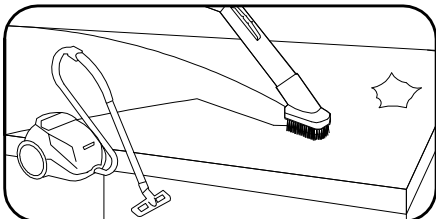
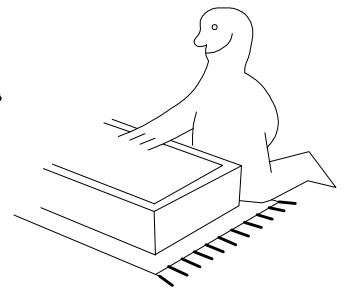
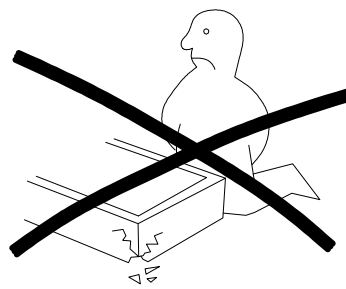
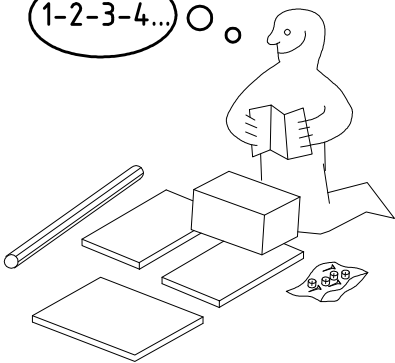

1-2-3-4... ○







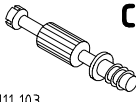

980818



03.12.16 / -

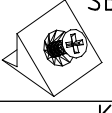

12 16 | 1/11

 111 xxx	A1	24x
 111 103	C	8x
	F3	8x

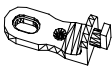
 111 xxx	S0	15x
 111 xxx ∅12	V12	15x
 121 370 3,5 x 15 mm	G1	48x

 117 002	K2	6x
	SBV	24x
 100cm 112 400	K10	3x

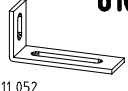

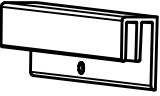

 111 611	J2	15x
 112 055 6,3 x 10,5 mm	T1	42x
 111 607	L8	24x

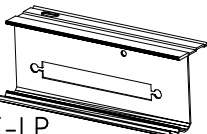

 111 052	o10	1x
 121 120 4 x 15mm	SP15	4x

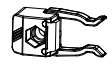
1x 
FPK
1453/1940/2430/2920/3408

1x 
SWT-LP
1453/1940/2430/2920SY
/3410 SY

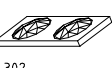
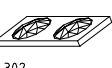

 121 xxx	SWT-ST	2x
 121 xxx M4 x 13 mm	SWT-SM5 GH13	2x
 121 xxx M4 x 10 mm	G13	6x
 121 xxx 3,5 x 35 mm	G43 G14	6x
 121 375	G14	2x

 121 004	SWH-SKL	1x
 121 004 3,5 x 22 mm	SWH-SKR G24	1x
 352 302	KP8	10x
	KP8	4x

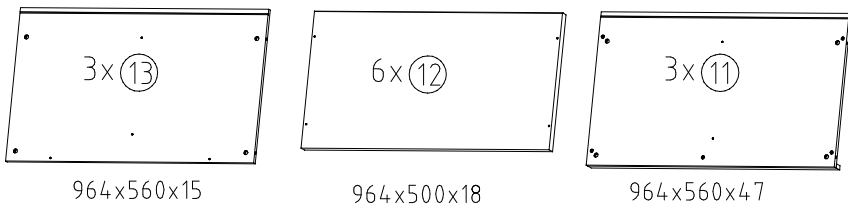
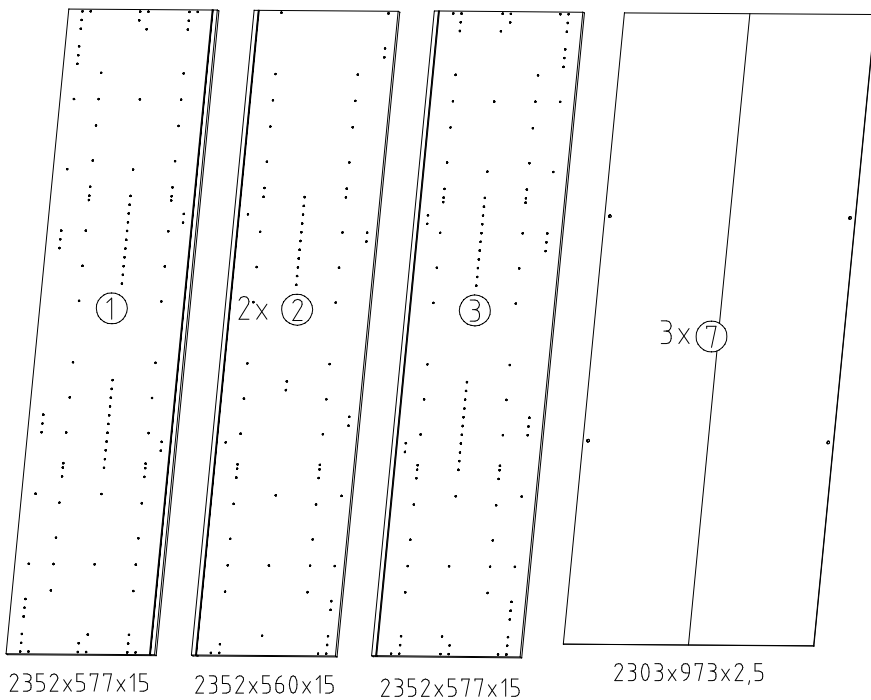
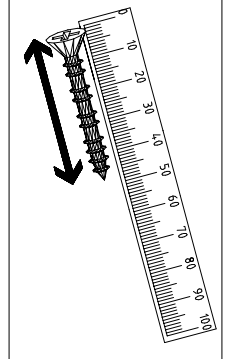
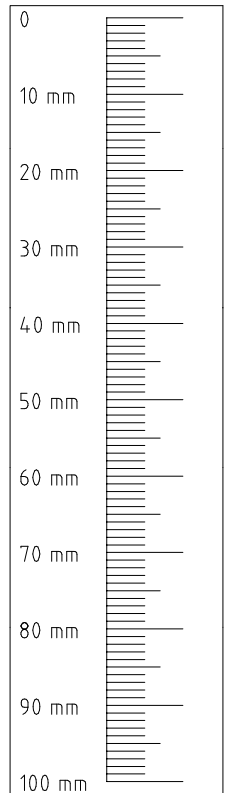
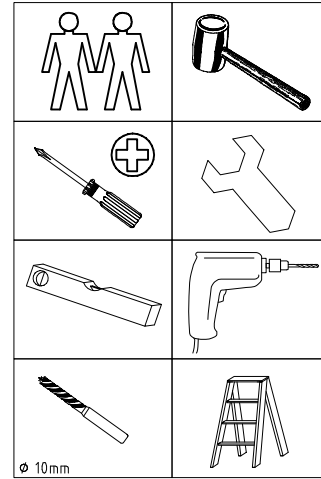

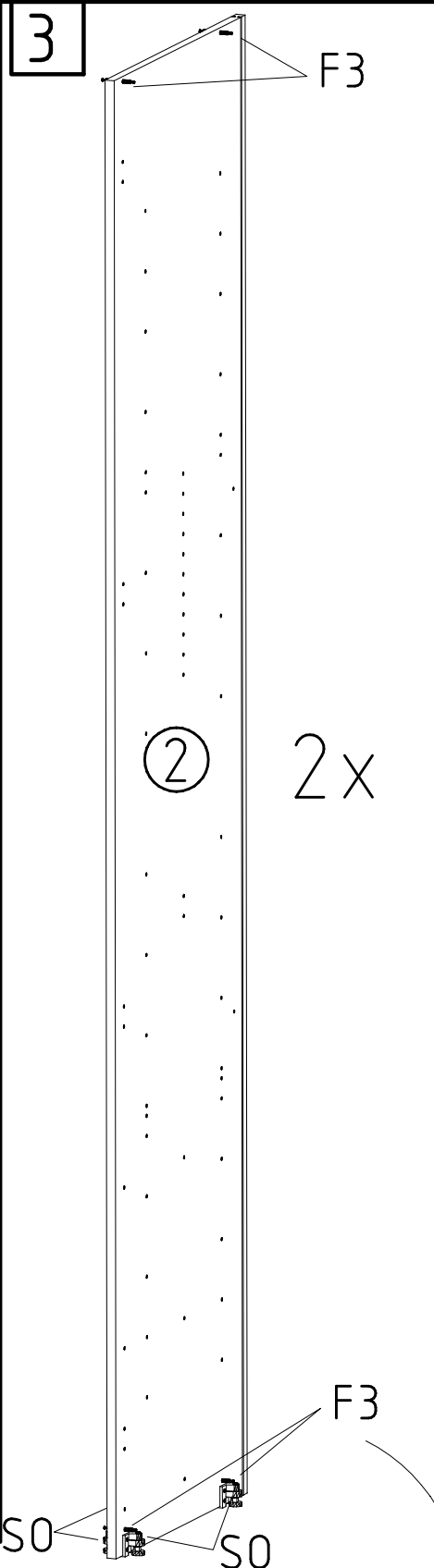
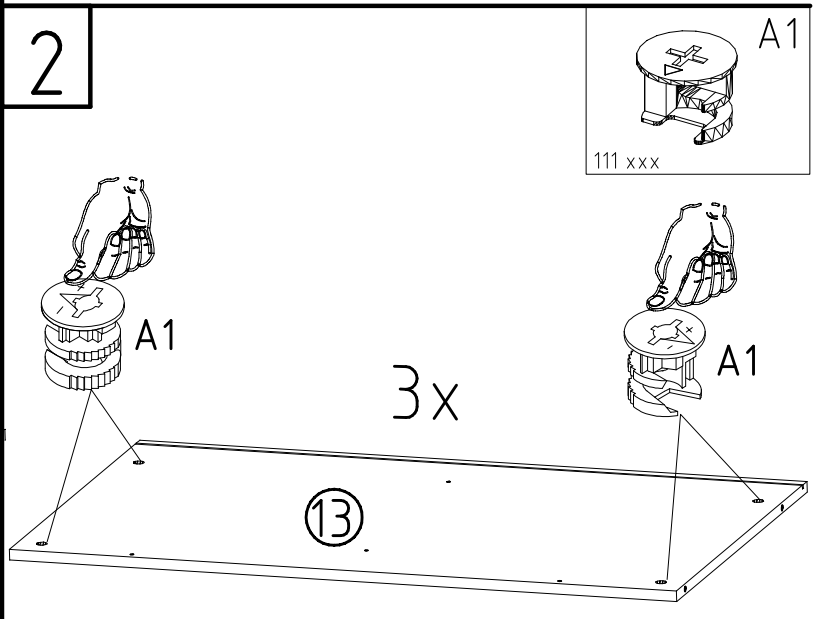
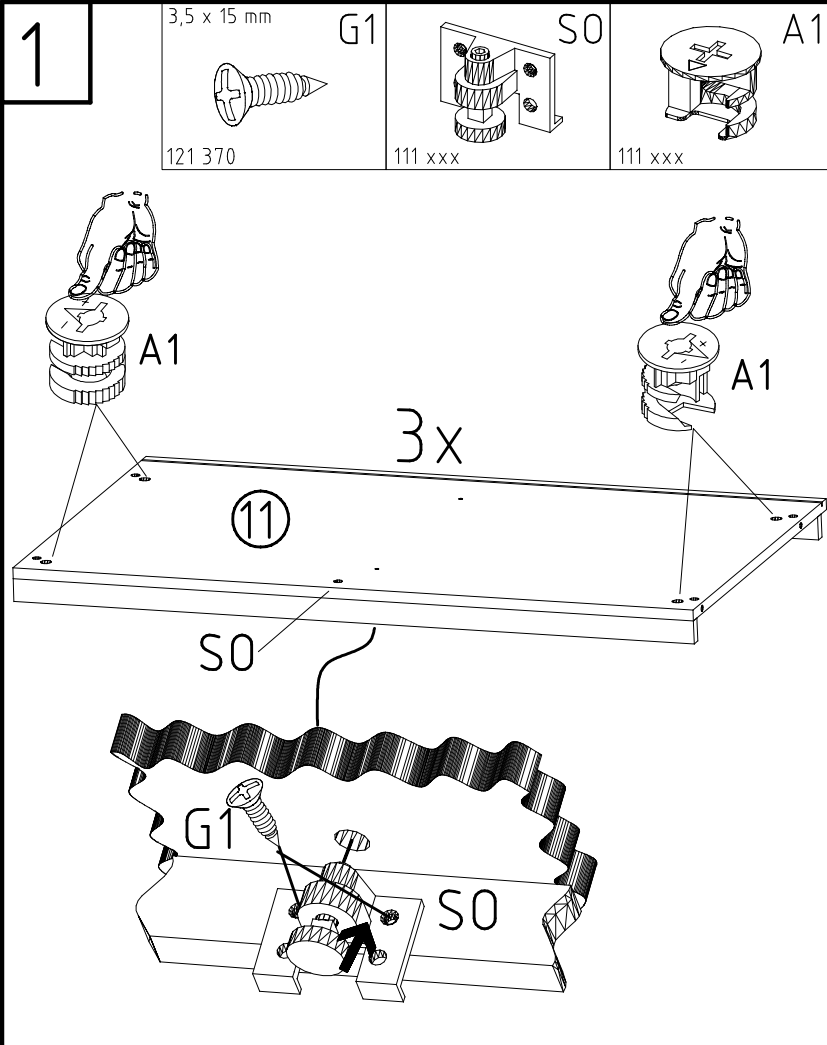

6,3 x 10,5 mm T1
112 055

3,5 x 15 mm G1
121 370

S0
111 xxx

F3

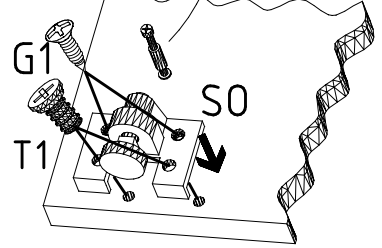
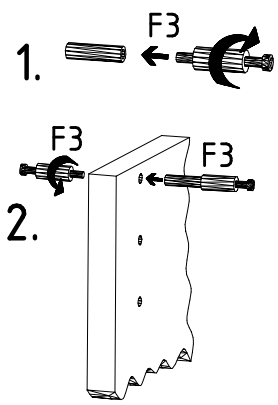

4

SWH-SKL

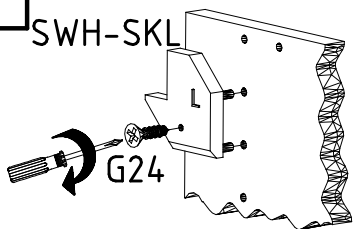

SWH-SKR

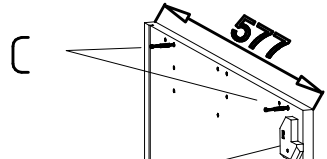
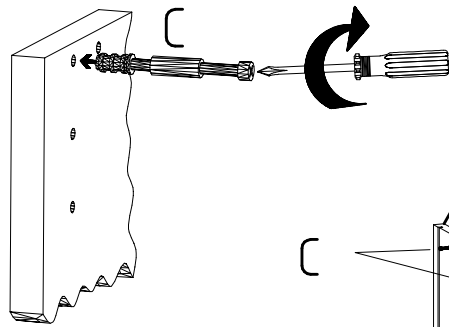
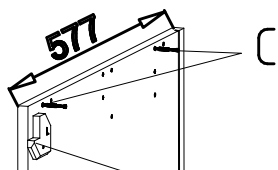
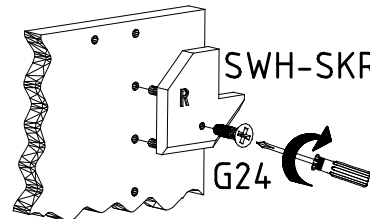

SWH-SKL +G24

SWH-SKR +G24

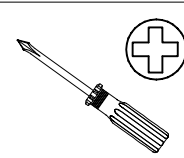

SWH-SKL

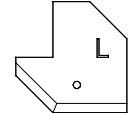

SWH-SKR

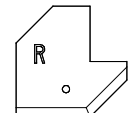

3,5 x 22 mm G24

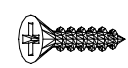

121 004

6,3 x 10,5 mm T1

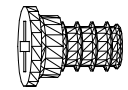

112 055

3,5 x 15 mm G1

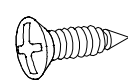

121 370

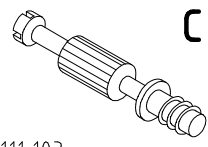

111 103

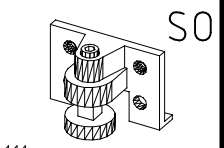

111 xxx

1

3

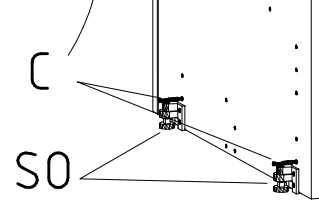
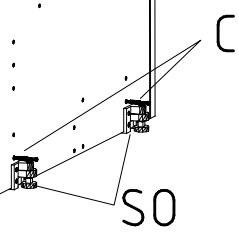
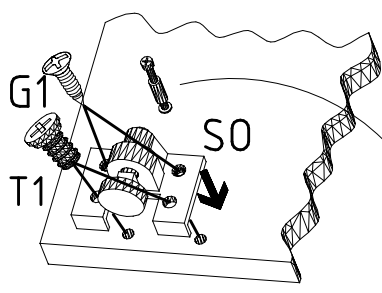

980818

03.12.16 / -

12 16

4/11

5

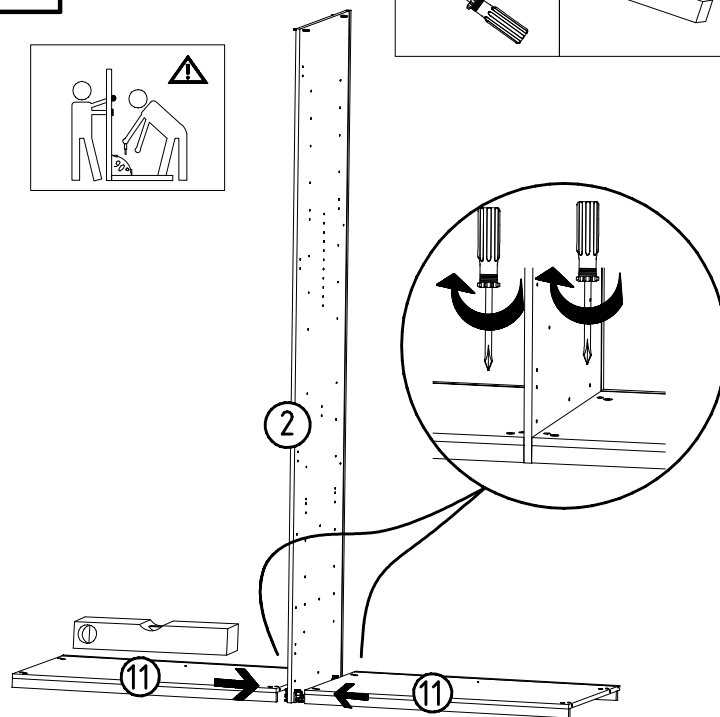
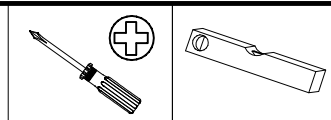

6

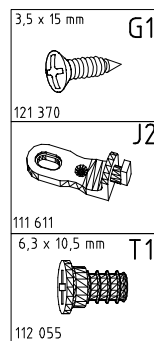
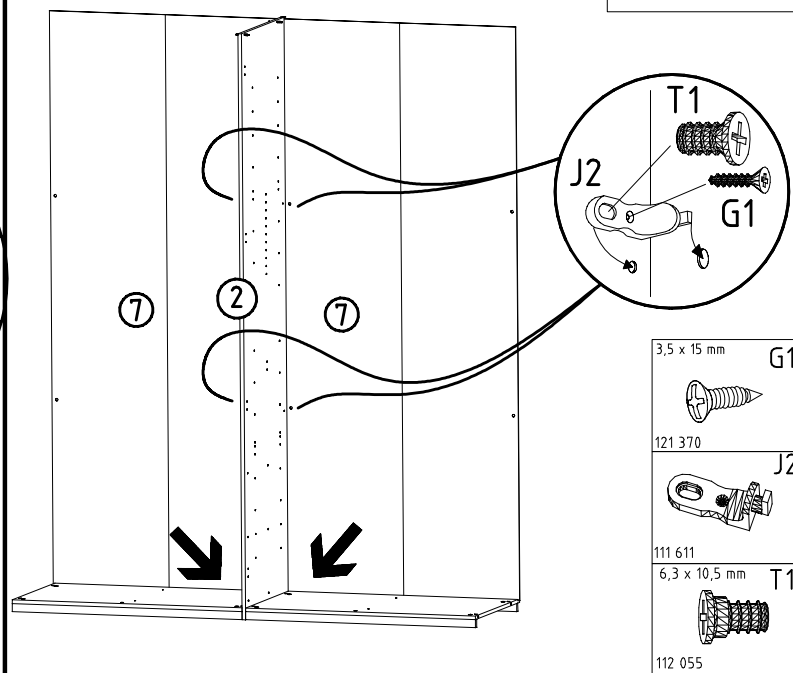
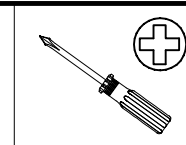

7

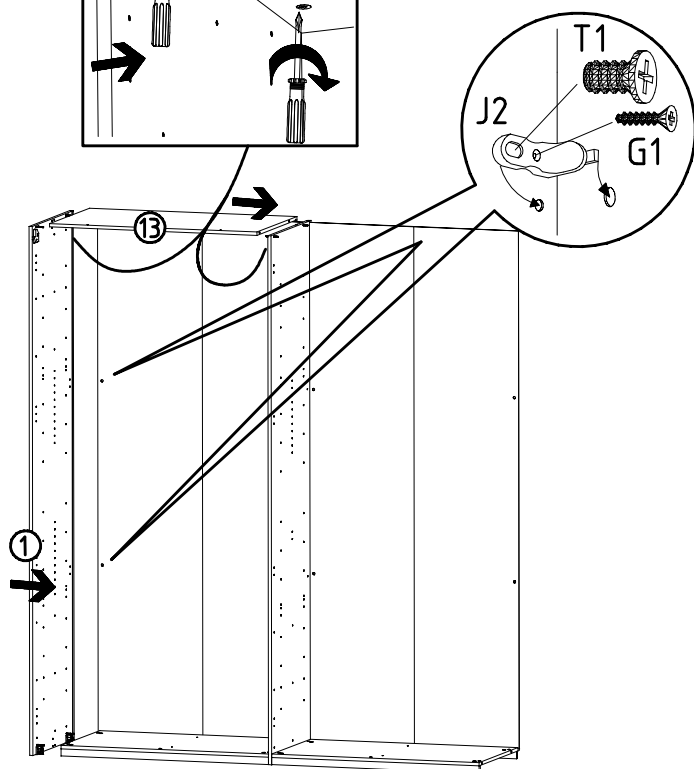
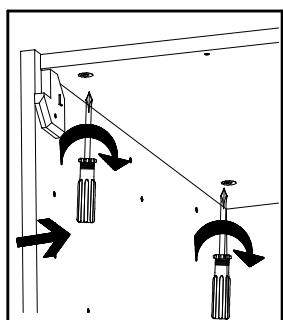
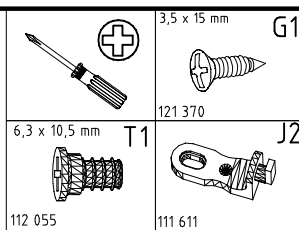

8

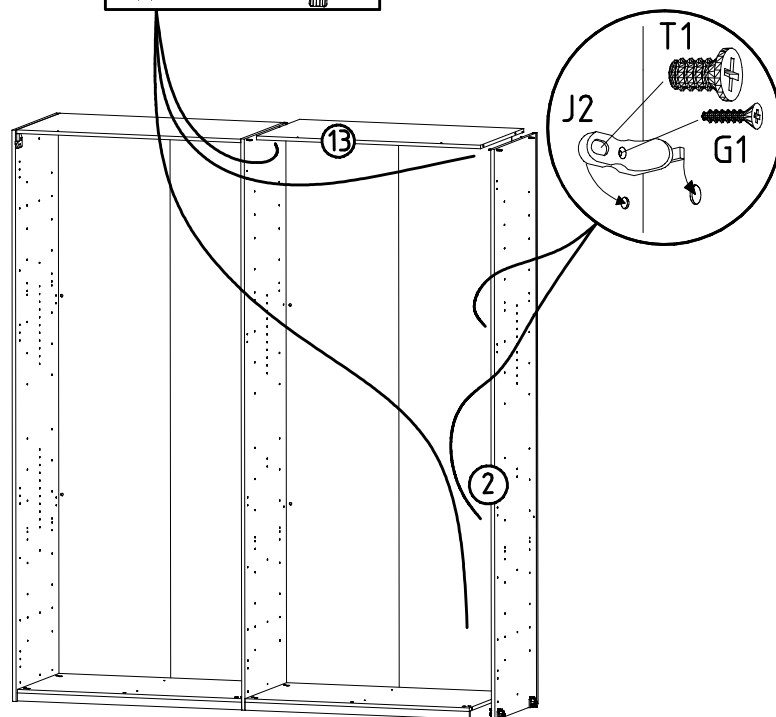
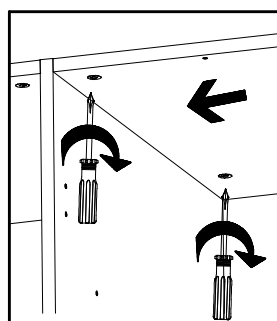
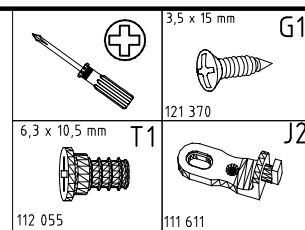

9

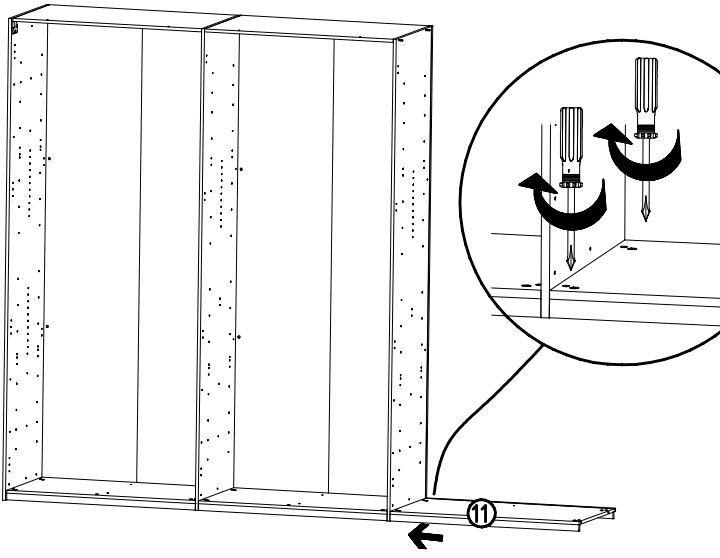
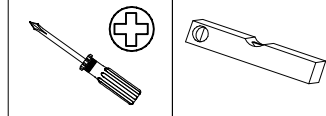
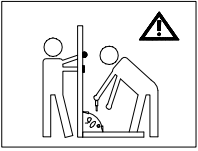

10

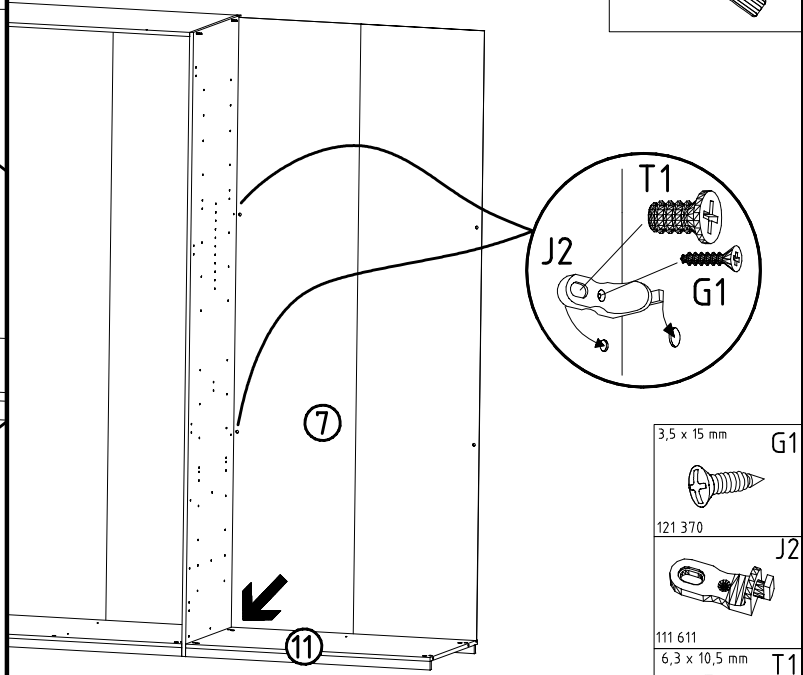
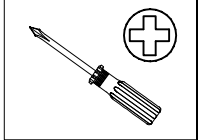

- 3,5 x 15 mm G1
- 121 370
- 111 611
- 6,3 x 10,5 mm T1
- 112 055

11

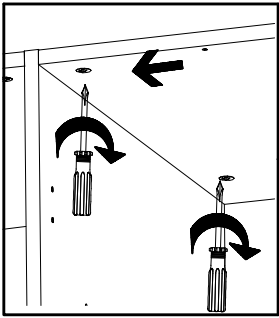

- 3,5 x 15 mm G1
- 121 370
- 111 611
- 6,3 x 10,5 mm T1
- 112 055

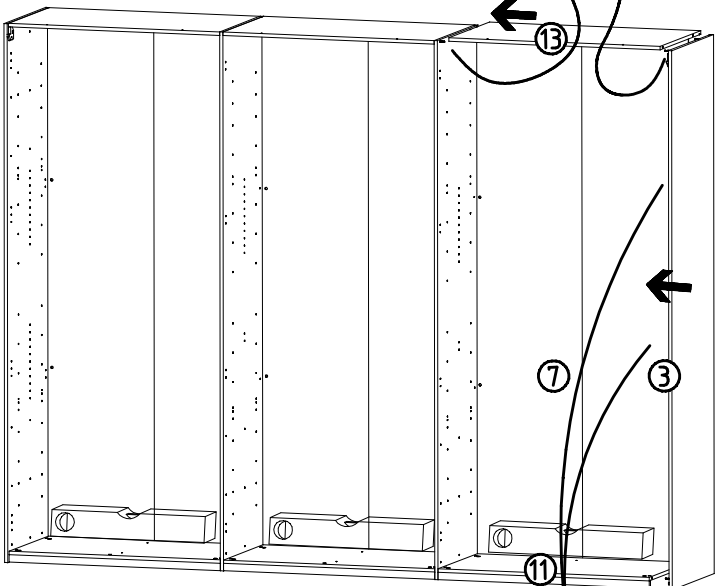

12

- L8
- 111 607
- K2
- 117 002
- 3,5 x 15 mm G1
- 121 370
- 100cm
- 112 400

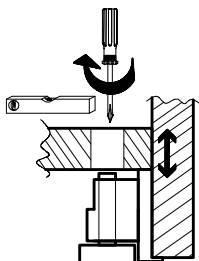
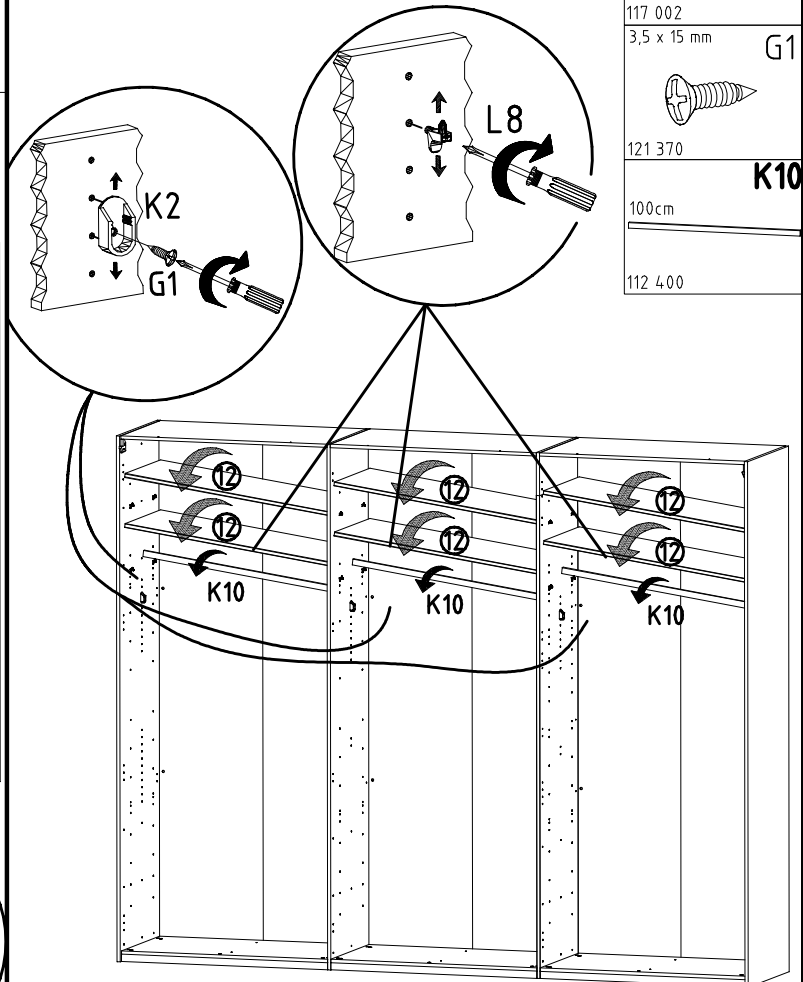

13

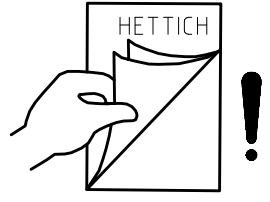
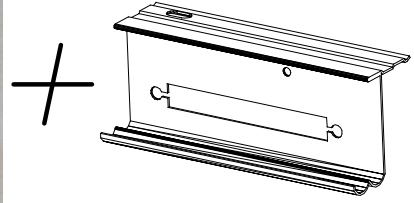
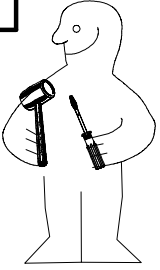

14

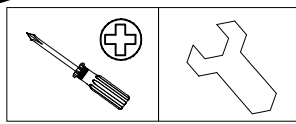
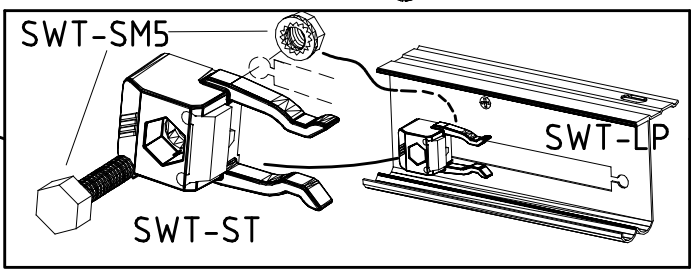
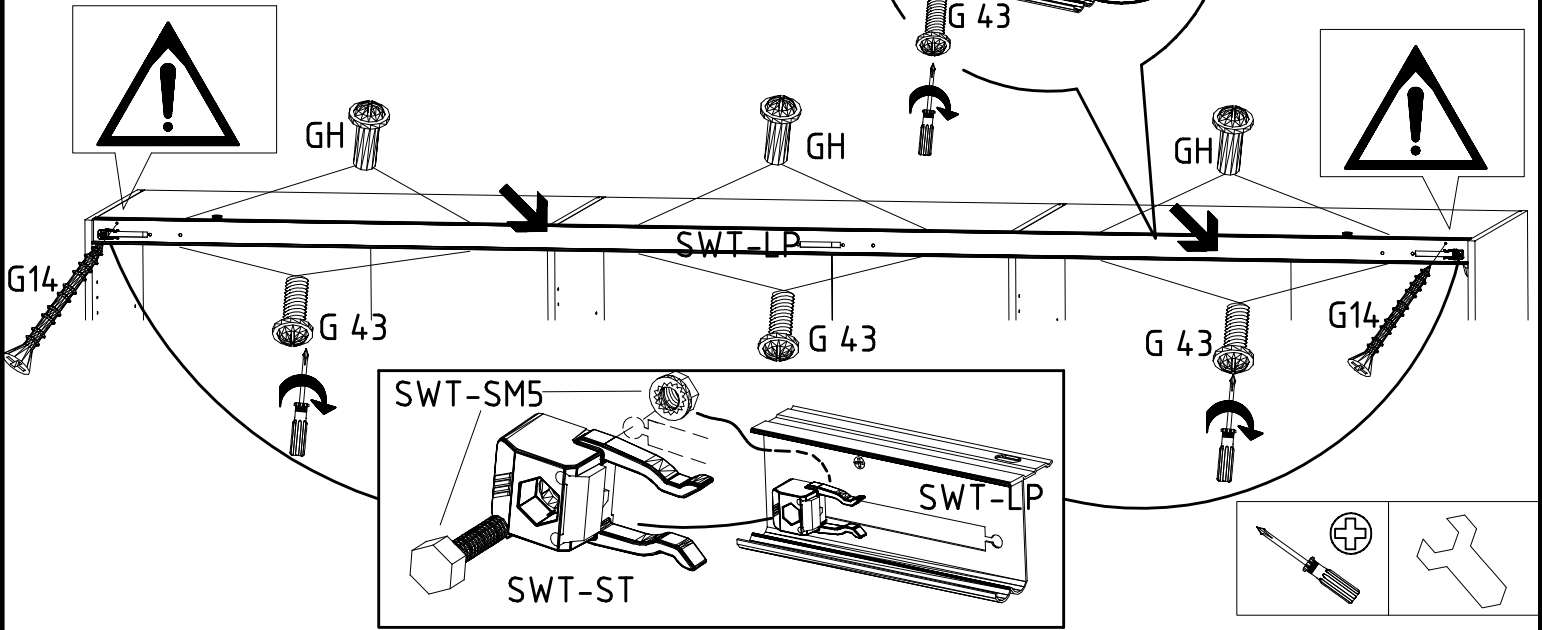
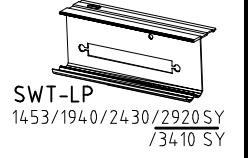
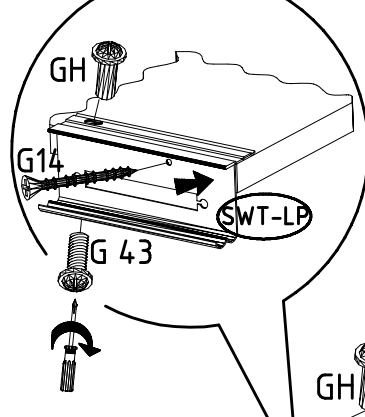
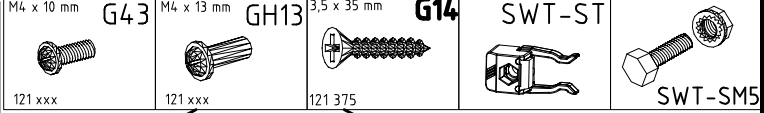
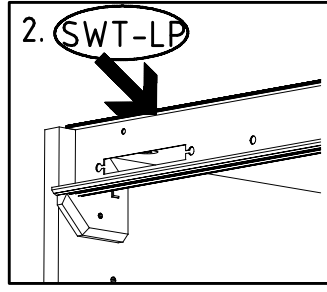
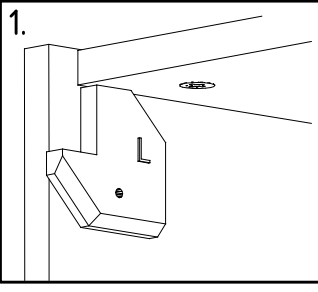

15

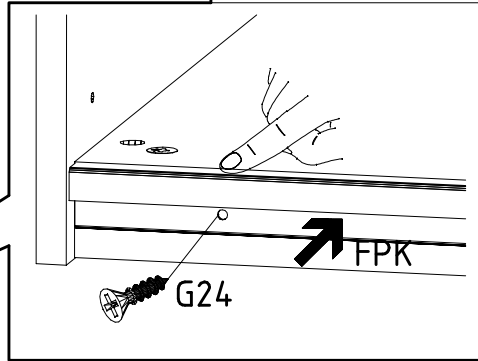
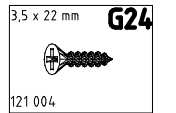
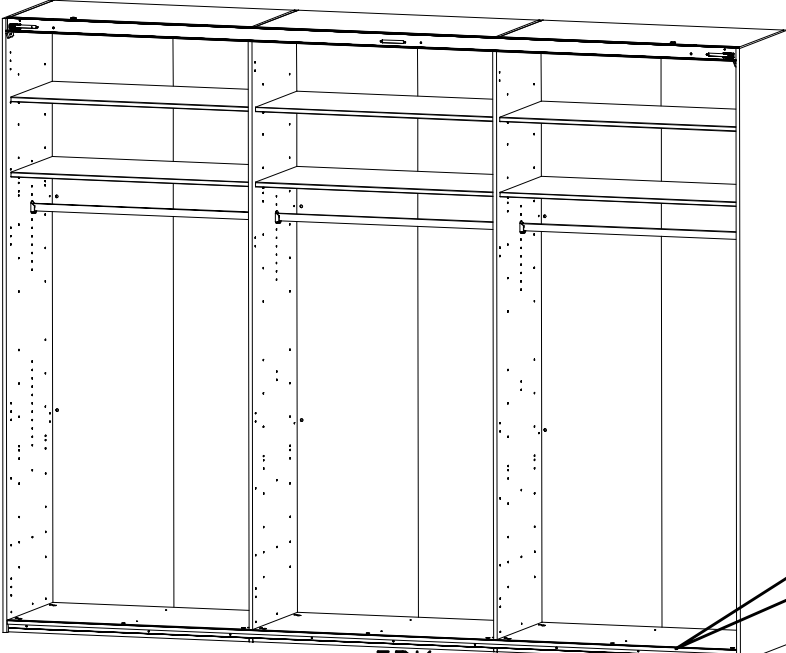

16

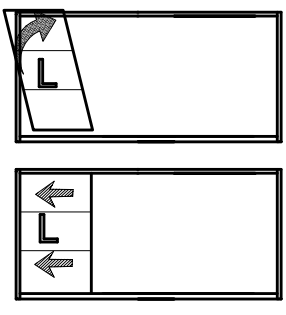

17

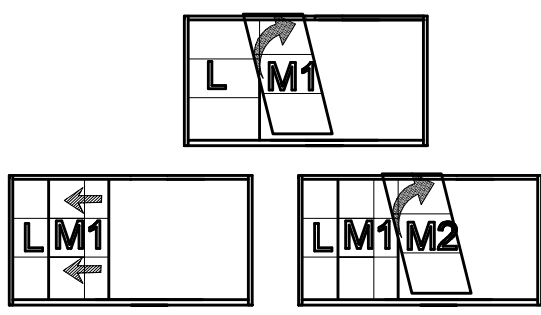

18

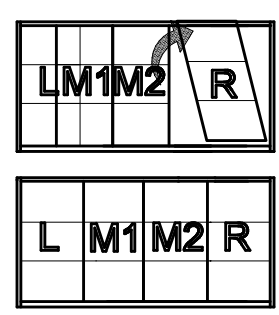

16 + 18

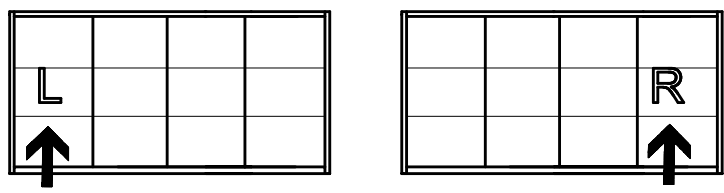

17

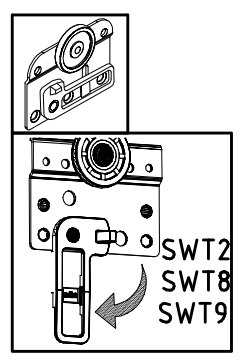
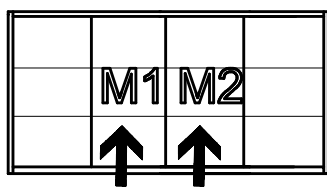

I.

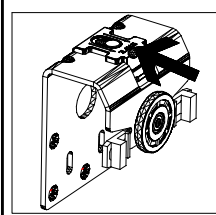
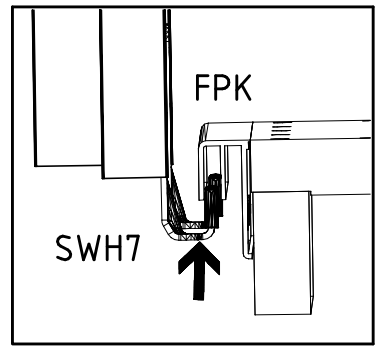

I.

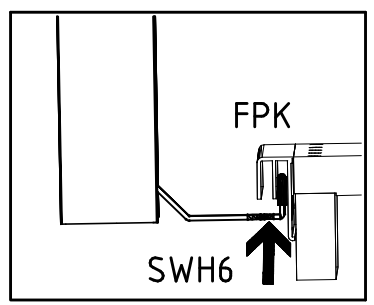

II.

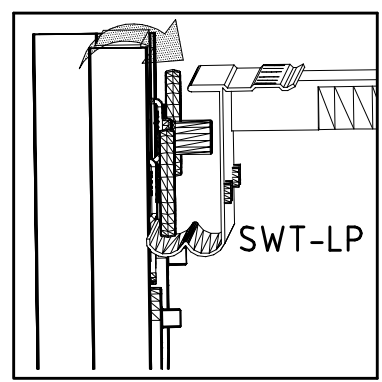

II.

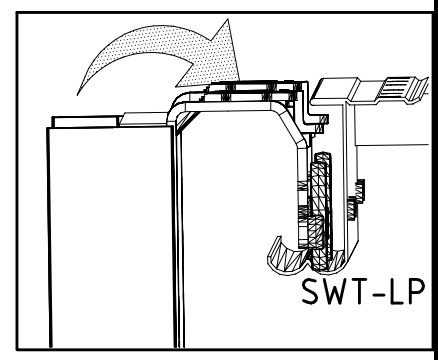

III.

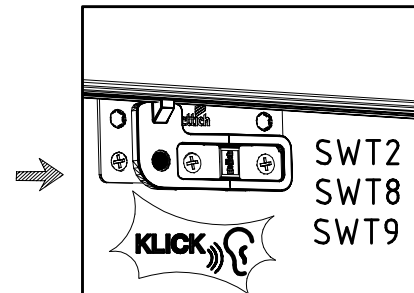
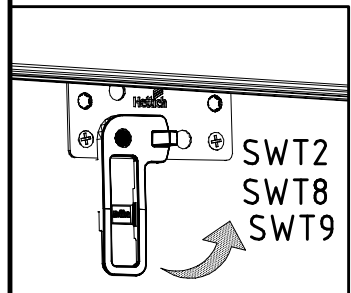

III.

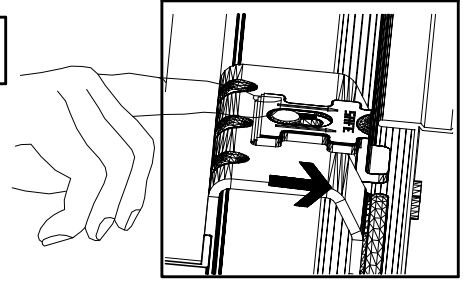

19

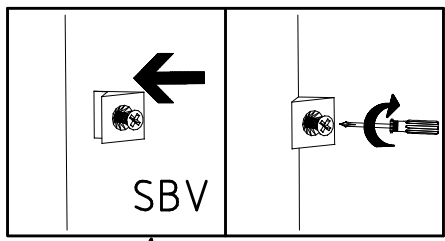

SBV

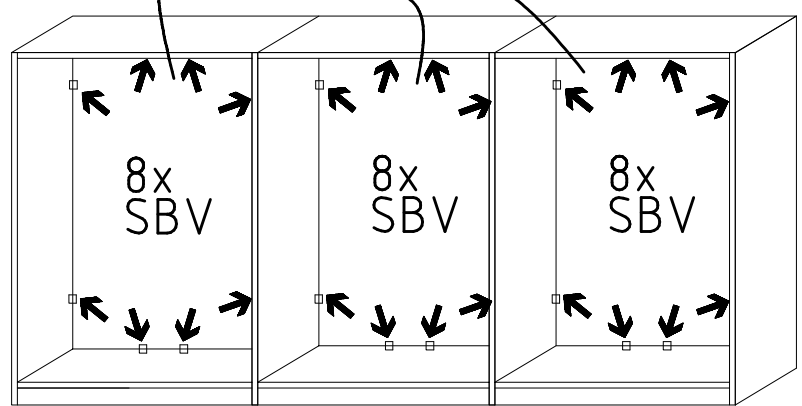
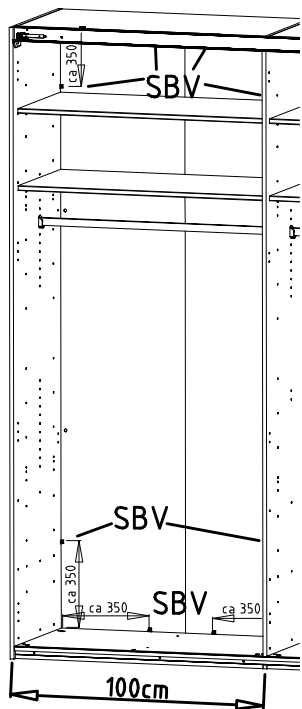
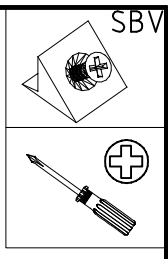

20

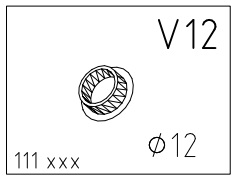
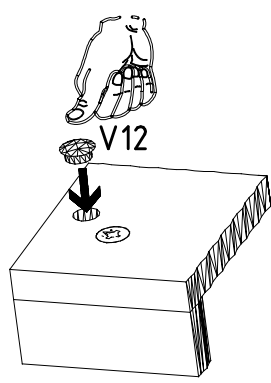
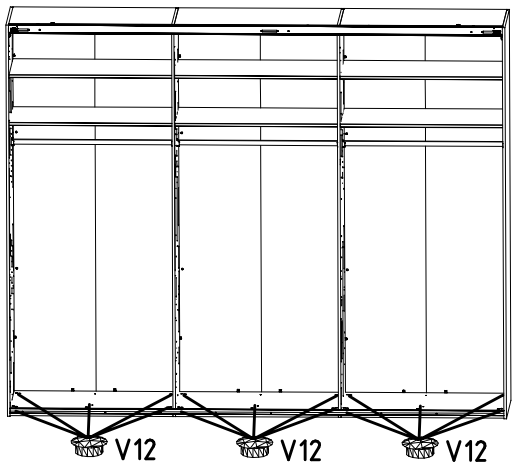

21

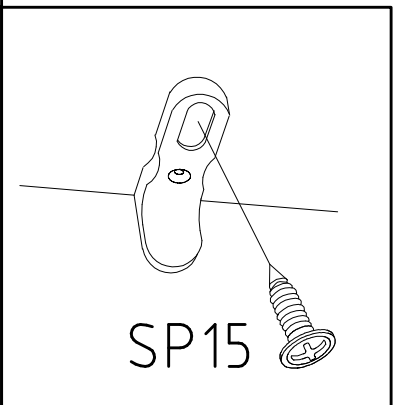
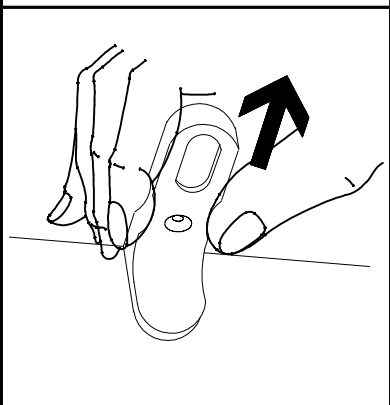
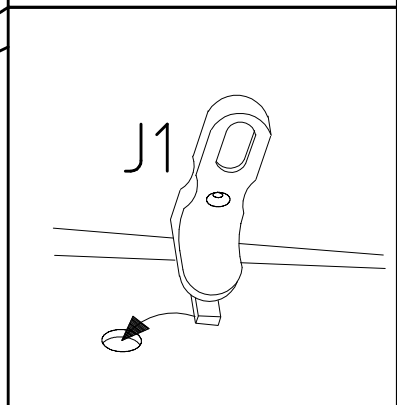
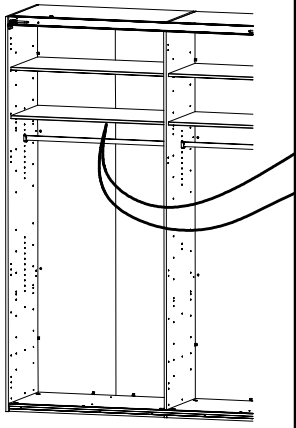
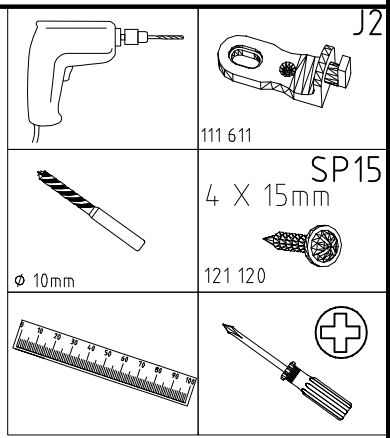
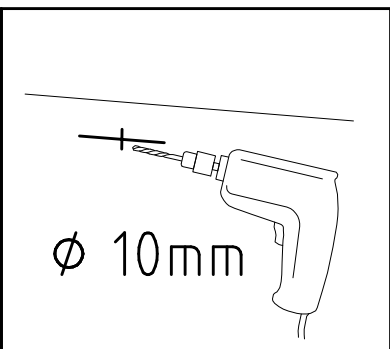
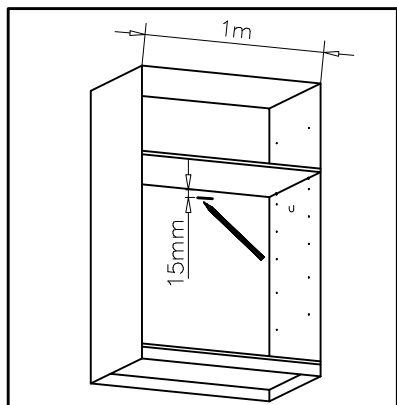

22

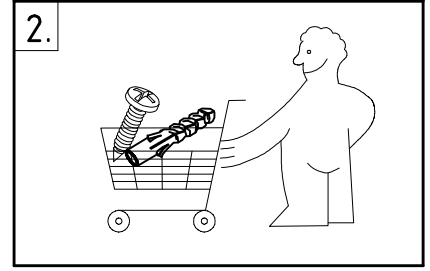
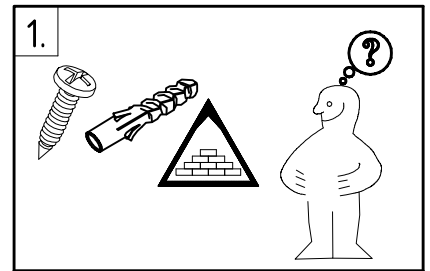
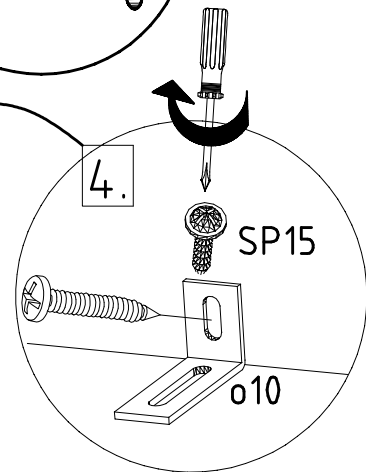
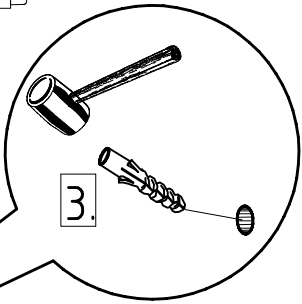
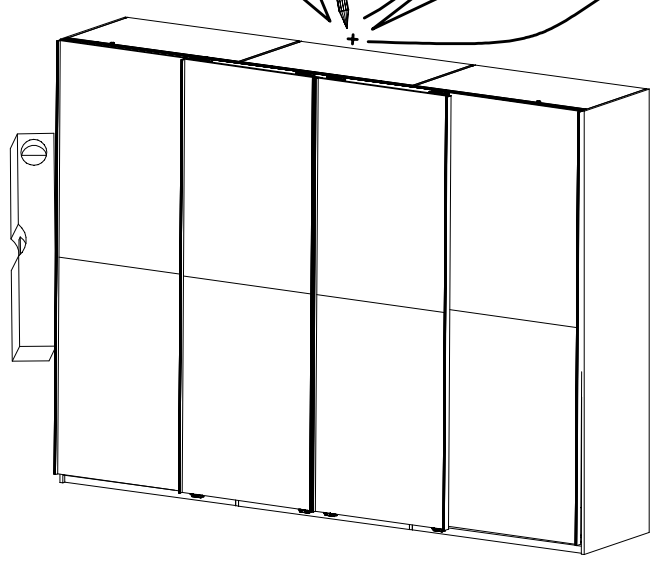
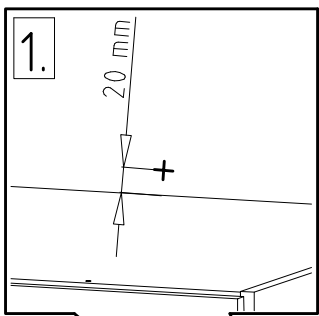
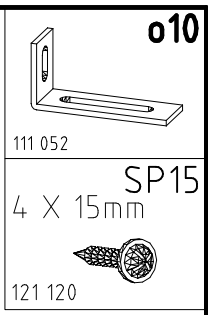
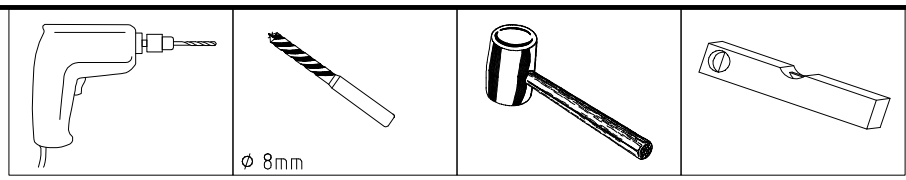

23

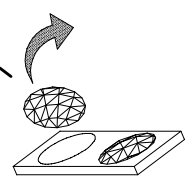
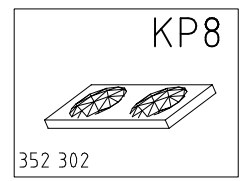
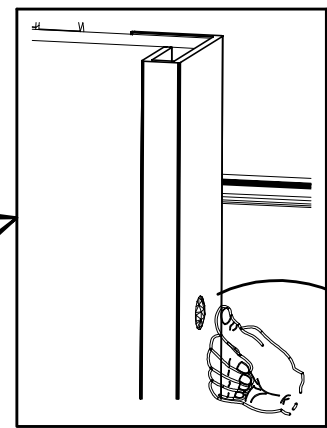
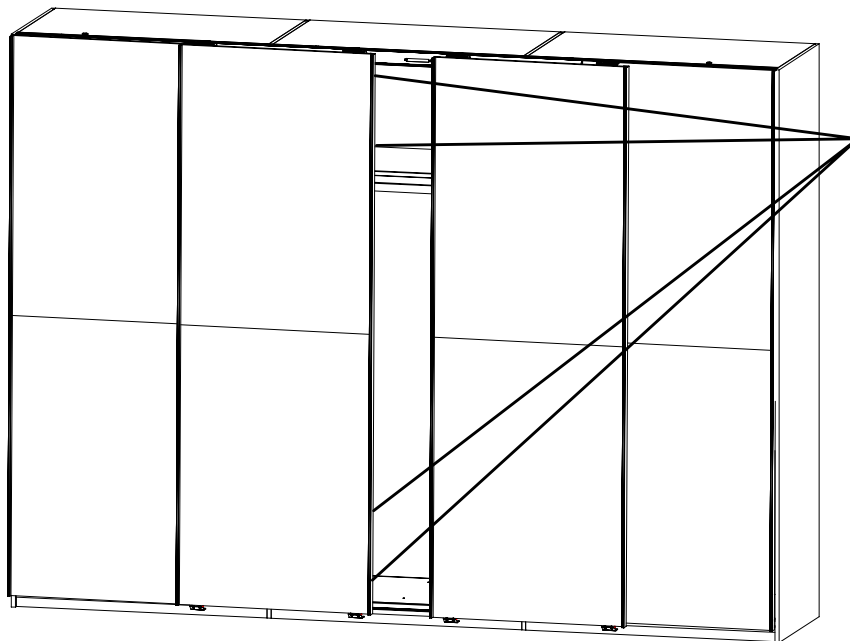

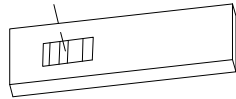
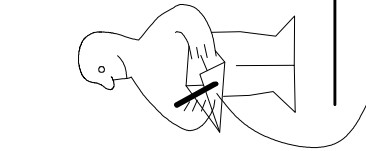
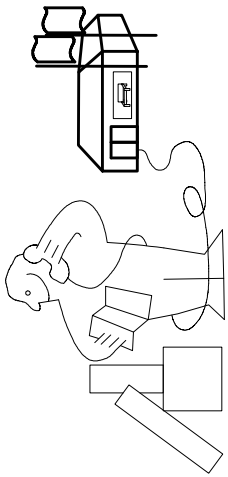
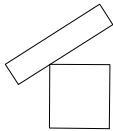
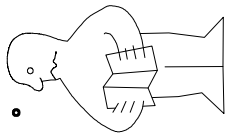

Modell/Model/Modèle

--	--	--	--

--	--	--	--	--	--

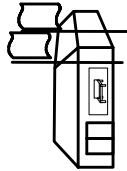

--	--	--	--	--	--

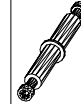
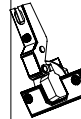
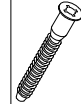

{121 370}	{ G 1 }	{4x}

Änderungen die dem technischen Fortschritt geschuldet sind, behalten wir uns vor !

Bei nicht vorschriftsmäßiger und/ oder nicht fachmännischer Montage wird bei Personen- und/ oder Sachschäden keinerlei Haftung übernommen.

WIMEX Wohnbedarf/ Import Export Handels GmbH/ Postfach 1407/ 49112 Georgsmarienhütte/ Germany
Tel.:(+49) 054-01 8598 16/17 Fax.:(+49) 054-01 8598 33 Mail: service_H@wimex-online.com

104P-NR. / 104P-NO. 150X-NR. / 150X-NO. Auftrag/Order-No. / No. de Commande

23203 **30110XY** 104

Kunde MAX MUSTERMANN
Customer
Client

Kommission / your order reference / votre reference

3377 MINDEN

Dekor / Decor Decor / Modell / Modele

F99 **SAMPLE**

F99842 SCHWEBETUERENSCHRANK 250 CM H 216CM
PLANKENEICHE NB + RAH STEEL
PLANKENEICHE NACHBILDUNG

202320301107241476000001

Paket / Package / Paquet

414760

SOCKEL

Paket 1 von 8 Colli Kommission 10

HSP-SMT BOD 50 TEXT/TEX SOCKEL 32 FRESH TV / LF 104
SO-BOD TEXT RASTEX/ ZNBOD D18MM TX KLSTA

Montage - Anleitung Laenge 520,0 OBEREN
KS-64 Breite 568,0 OBEREN

SOCKEL32 KLEB

Bei Warenauslieferung für Rückgabe beachten!
En cas de livraison de marchandises veuillez retourner le bordereau d'envoi.



OBEREN 5 30/19 HAUT 23.08.19 OBEREN 1 1. JABOVE OBEREN



WIMEX Wohnbedarf
Import Export Handelsges mbH & Co. KG
Werner-von-Siemens-Str. 35
D-49124 Georgsmarienhütte - Germany

SAMPLE **23.08.19**
Modellname Produktionsdatum
Model Date of manufacture

