

Kris



ASSEMBLING INSTRUCTIONS
MONTAGEANLEITUNG INSTRUKCJA MONTAŻU

**Please read the instruction carefully before assembling.
Bitte die Montageanleitung genau lesen.
Przed rozpoczęciem montażu przeczytaj uważnie instrukcję.**

HIDDEN ELEMENTS

VERSTECKTE ELEMENTE UKRYTE ELEMENTY

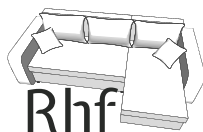
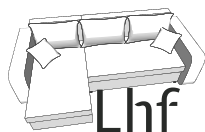

(EN) The furniture side can be changed, even after it has been folded.

(DE) Die Seite des Möbelstücks kann man auch nach der Montage noch ändern.

(PL) Stronę mebla można zmieniać, nawet po jego złożeniu.

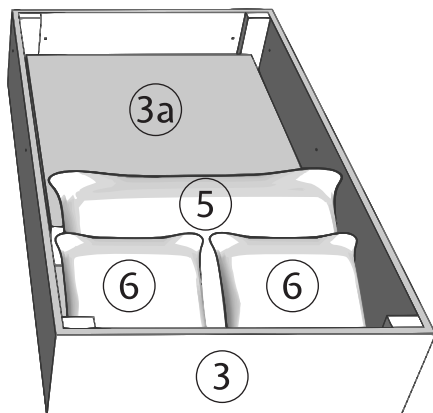
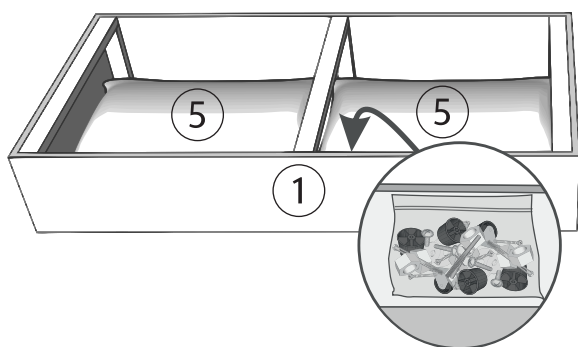

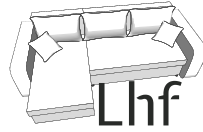

Lhf

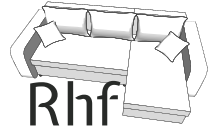

Rhf

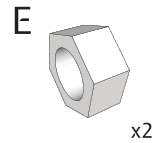
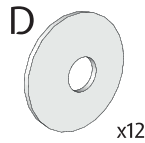
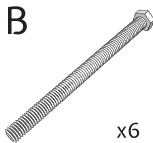
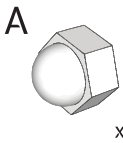
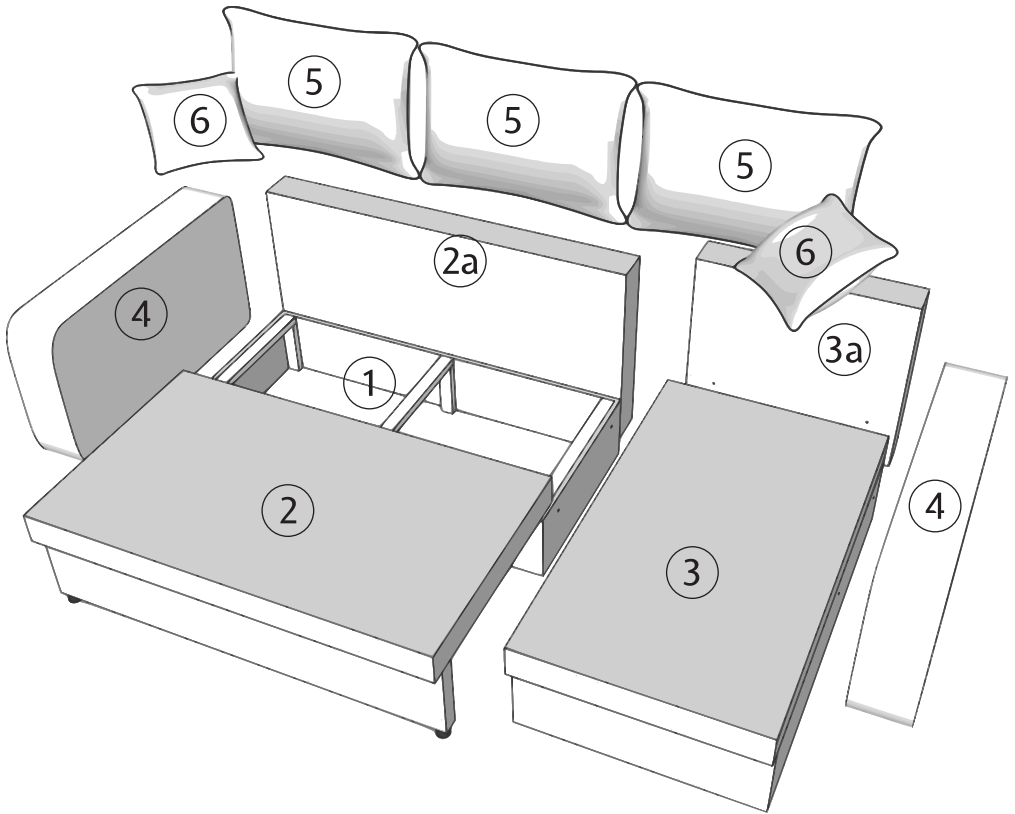

I

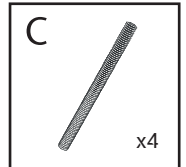
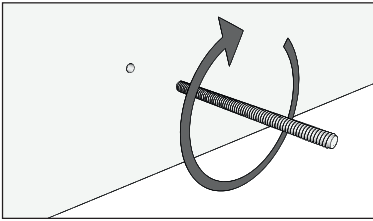
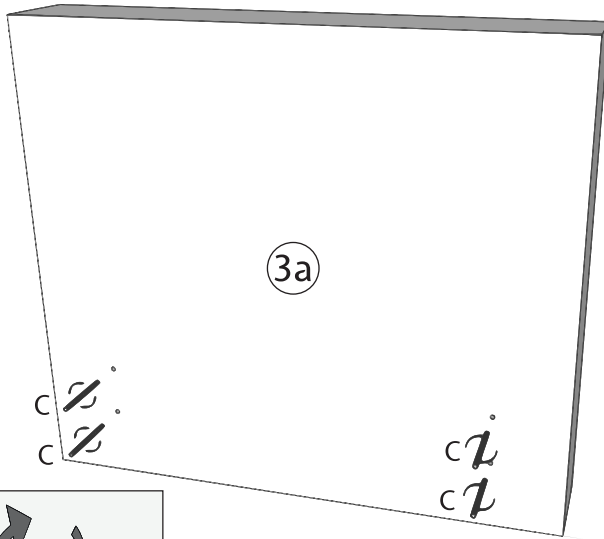

II

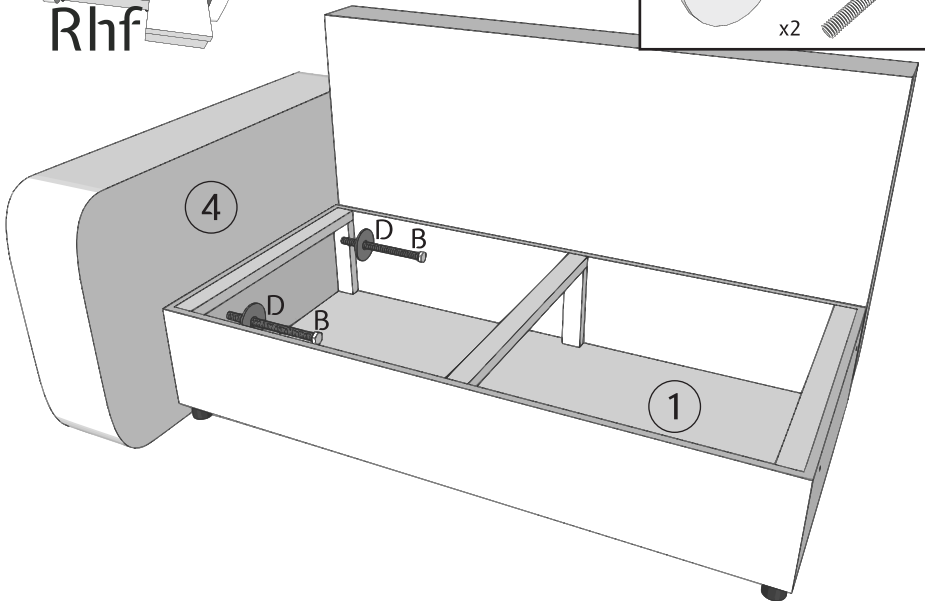
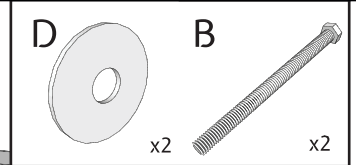
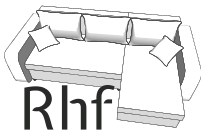

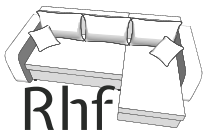
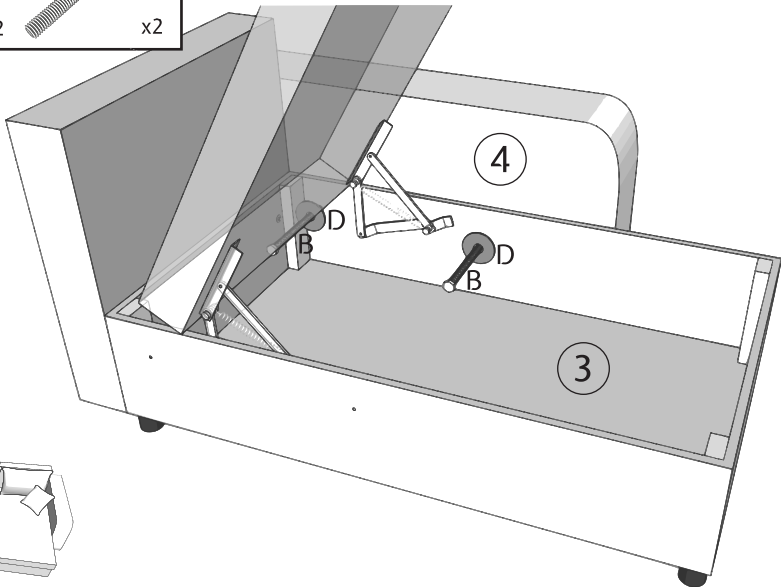
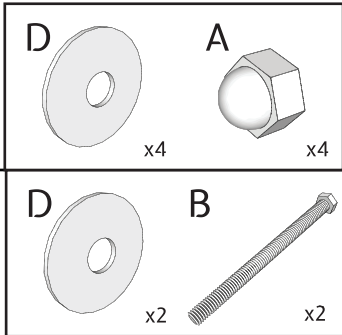
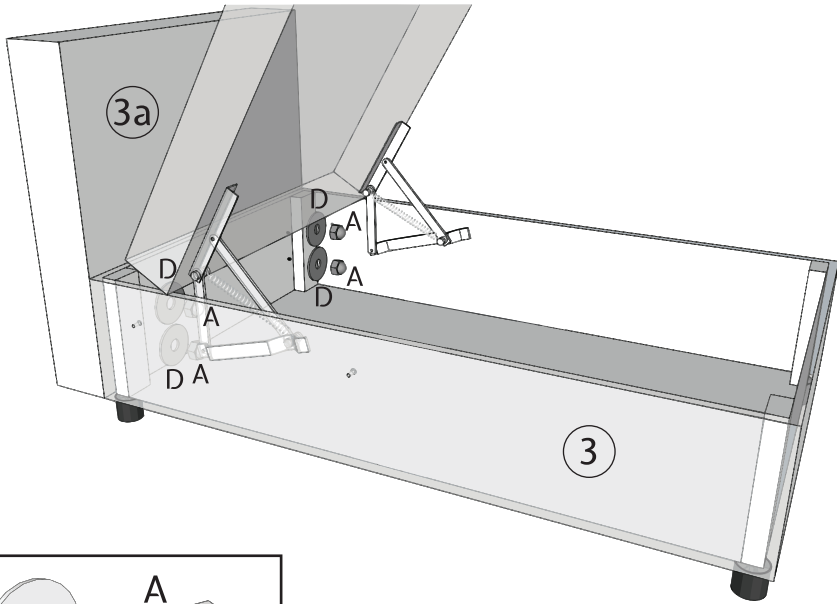

V

