

# BETA-ŁAWA

→ 120 × 48 × 60

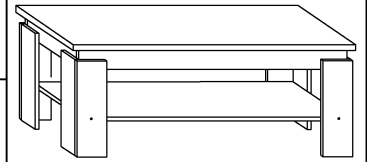

x 4



(a)

x 22



(b)

x 4



(c)

x 16

4x30

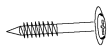

(d)

x 1



(e)

x 1



(f)

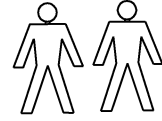
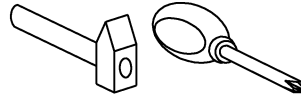

30 min



**1** - FAZY MONTAŻU

**A** - OZNACZENIE ELEMENTÓW

**a** - OZNACZENIE AKCESORIÓW

**1**

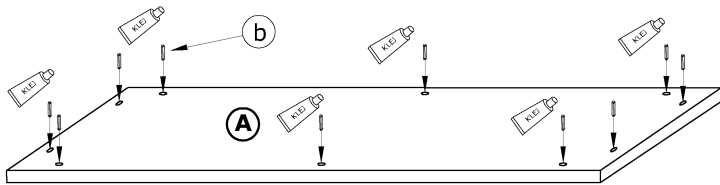

**2**

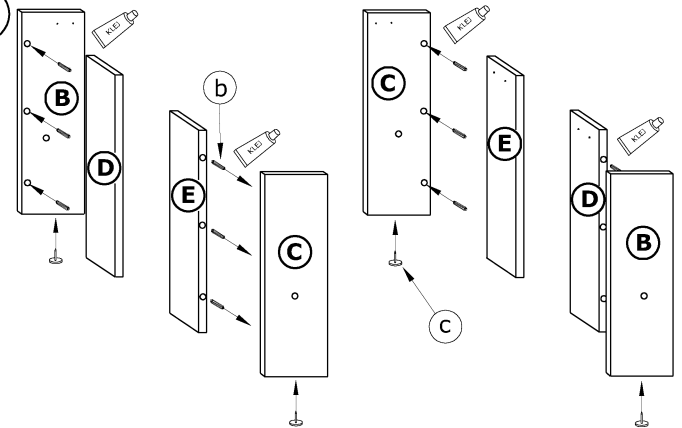

**3**

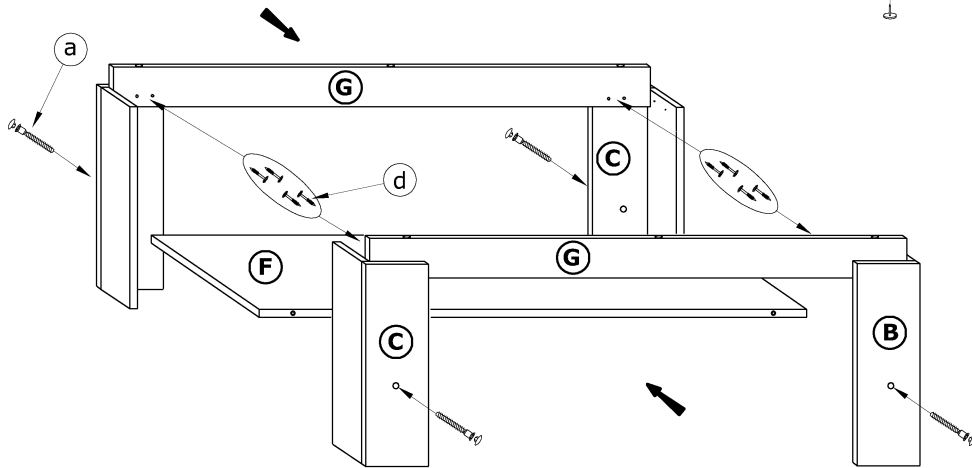

**4**

