

Montageanleitung

Notice de montage

Assembly instruction

GERMANIA[®]
the furniture factory

Regal 1698

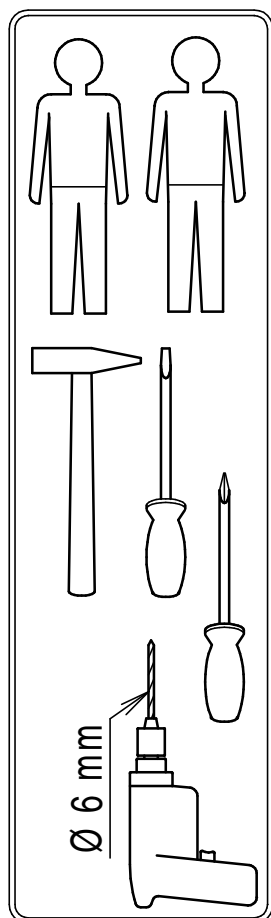
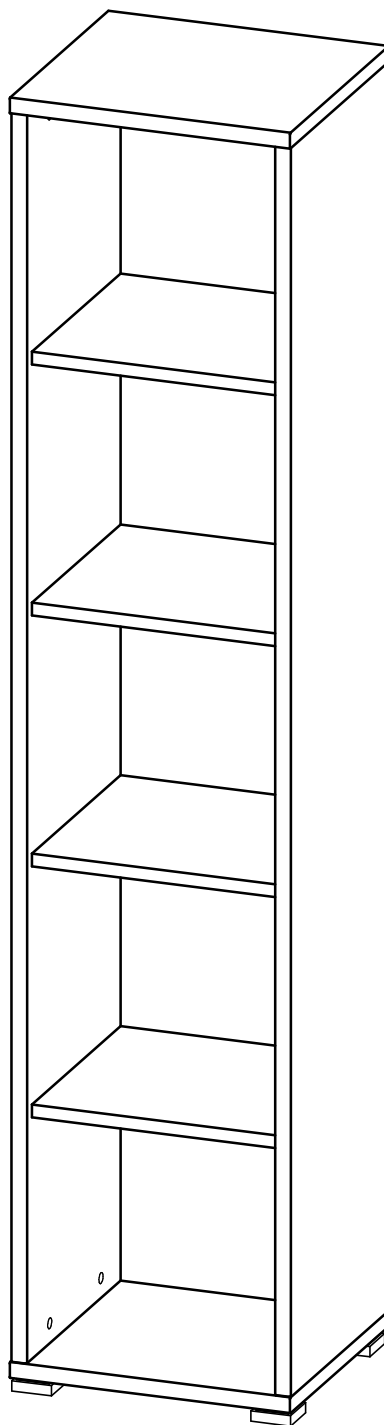

Bitte die Sicherheitshinweise auf der letzten Seite beachten!

Please note: safety instructions on the last page!

Prière de suivre les instructions de sécurité figurant sur la dernière page!

erstellt

Datum: 16.07.10







geändert

Datum:

geprüft

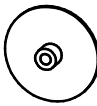
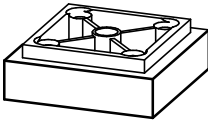
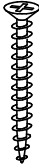
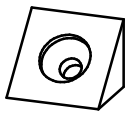
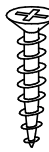
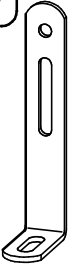
Datum: 25.08.10

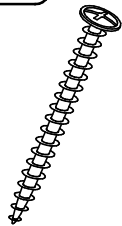
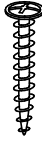
Mod. 1698 **Teileliste** - liste de pièces - partlist

<p>2218 24x</p>  <p>Ø8 x 30mm</p>	<p>1116 24x</p>  <p>Ø15mm</p>	<p>1114 24x</p>  <p>24 mm</p>	<p>1162 16x</p> 
<p>5403 4x</p>  <p>55x55 mm</p>	<p>1071 8x</p>  <p>Ø4x30mm</p>	<p>4095 4x</p>  <p>10x10x13mm</p>	<p>1058 4x</p>  <p>Ø3x15mm</p>
<p>1187 1x</p>  <p>90x30x15</p>	<p>1110 1x</p>  <p>Ø6x30mm</p>	<p>1021 1x</p>  <p>Ø4,5x40mm</p>	<p>1042 2x</p>  <p>Ø4x17mm</p>
<p>1267 12x</p>  <p>Ø3x16</p>	<p>1192 20x</p>  <p>Ø5mm</p>		

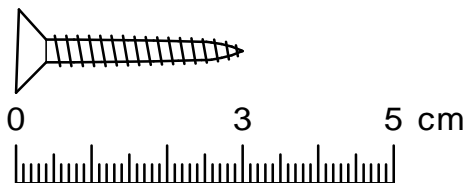

Mod. 1698 **Teileliste** - liste de pièces - partlist

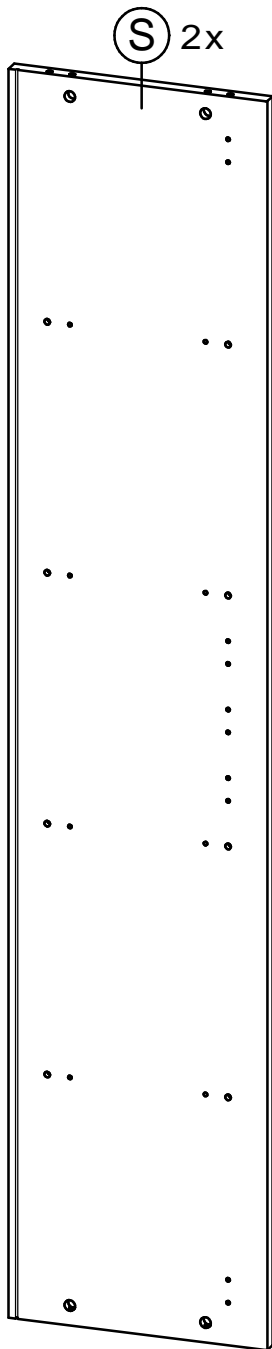
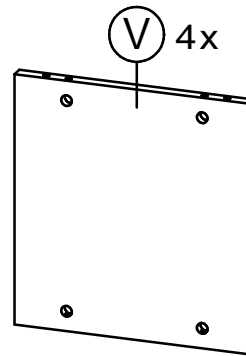
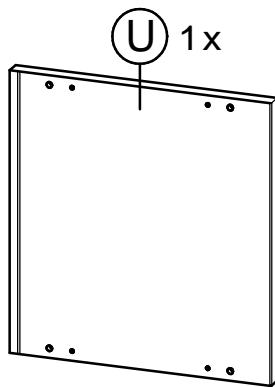
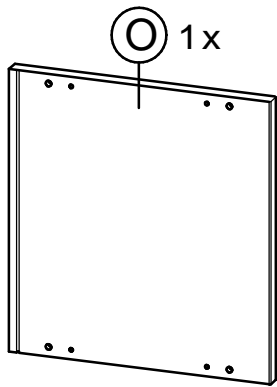

erstellt		geändert		geprüft	
Datum: 16.07.10		Datum:		Datum: 25.08.10	

Mod. 1698 **Montageschritte** - ordre de montage - assembly instructions

1.

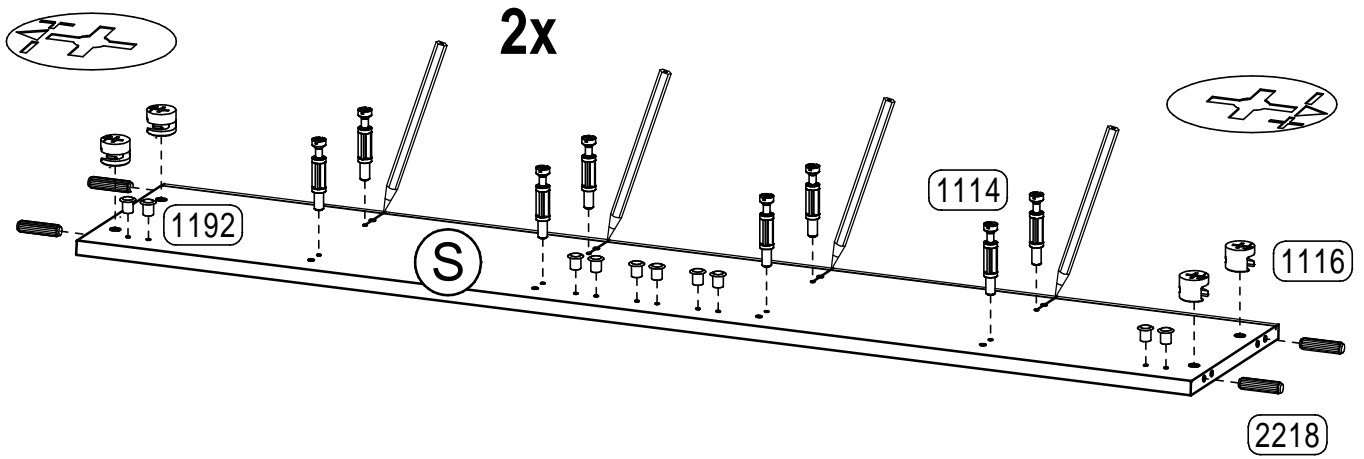
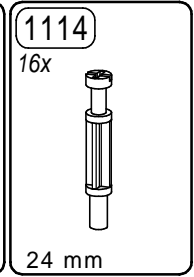
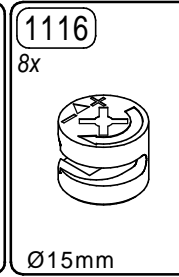
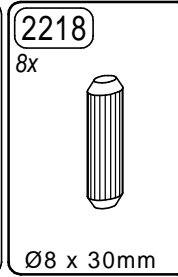
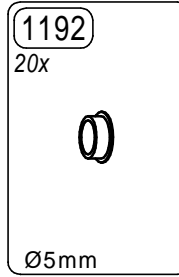
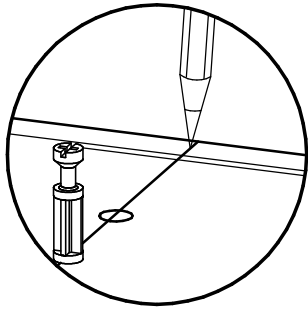

2.

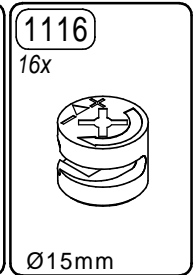
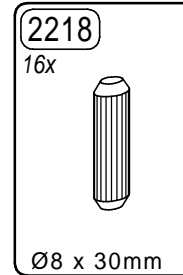
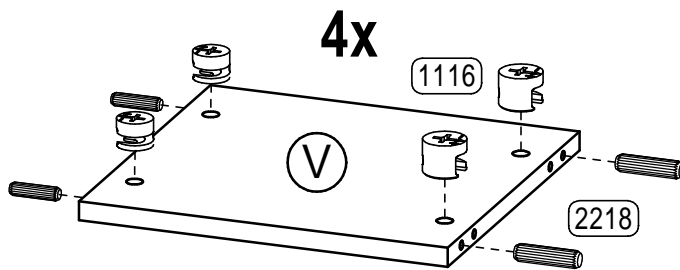

3.

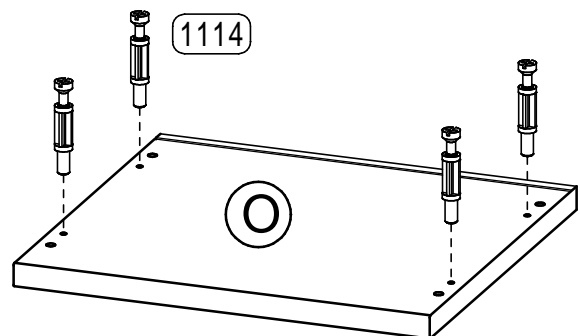
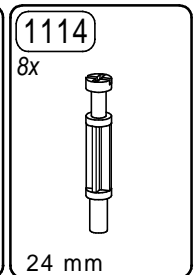
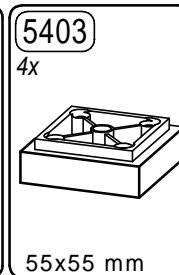
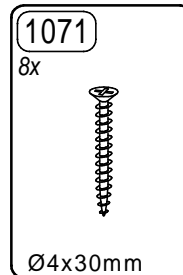
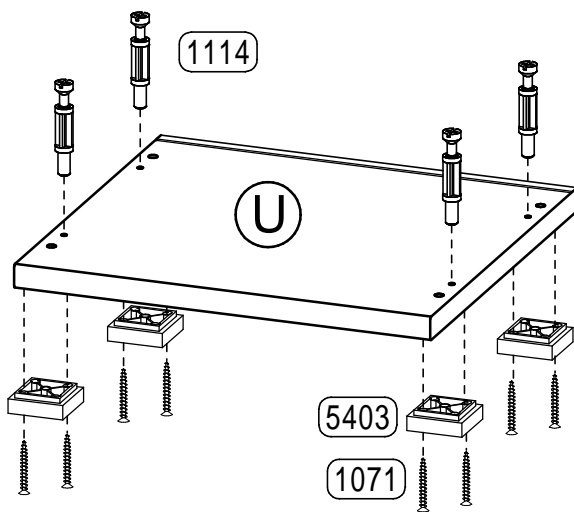

4

erstellt	geändert	geprüft
Datum: 16.07.10	Datum:	Datum: 25.08.10

4.

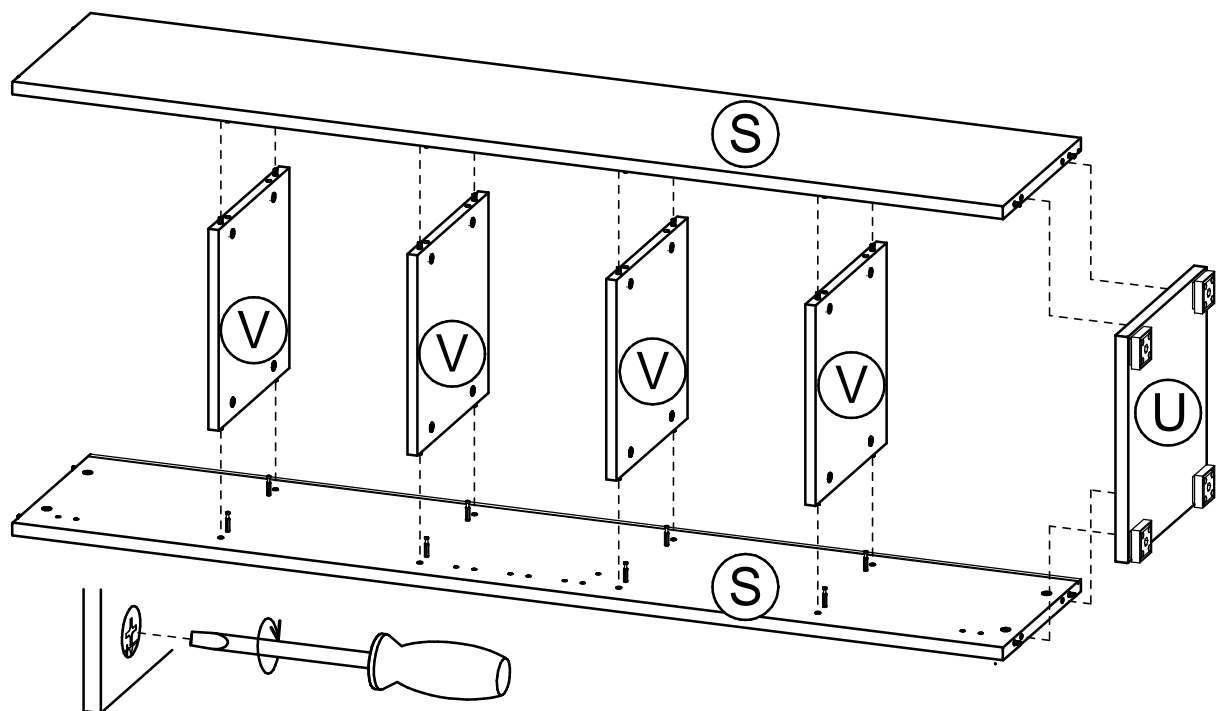

5

erstellt	geändert	geprüft
Datum: 16.07.10	Datum:	Datum: 25.08.10

5.

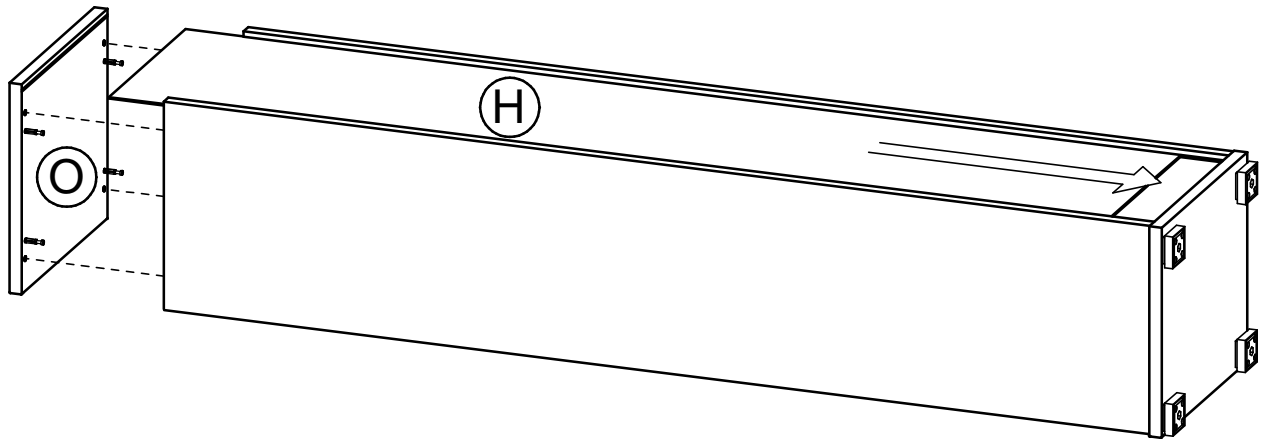

6.

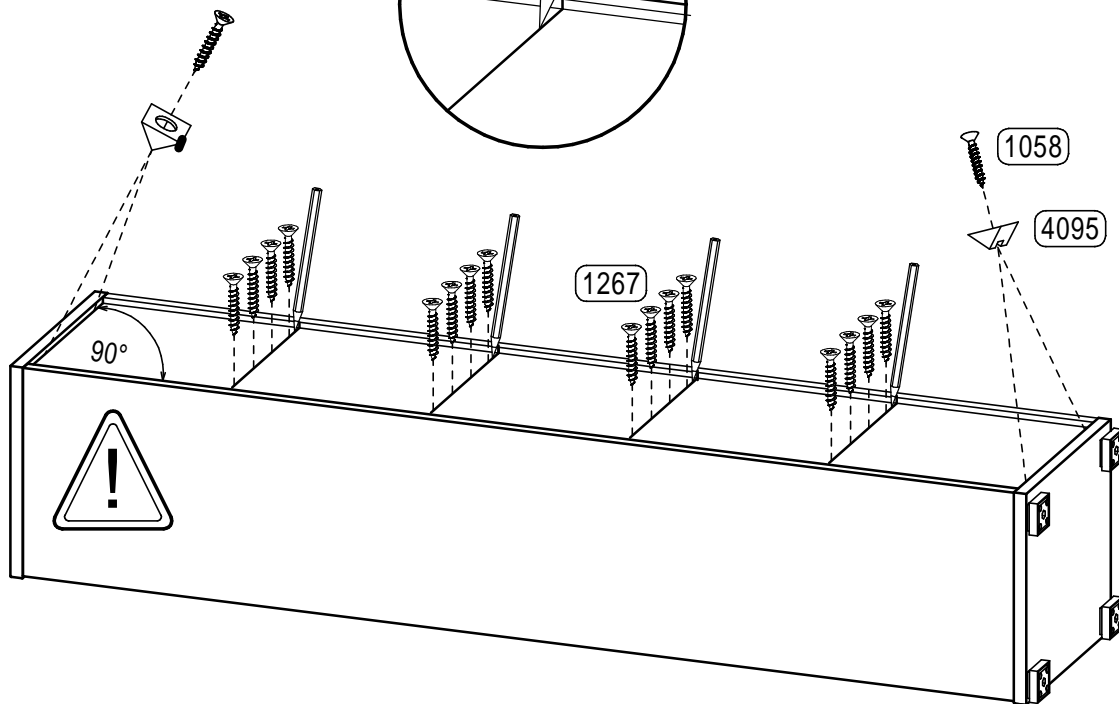
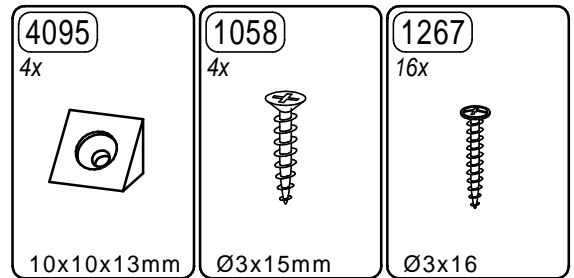
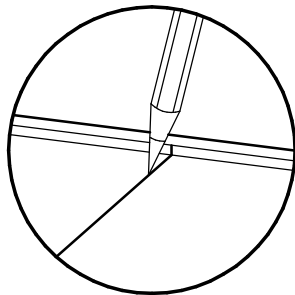
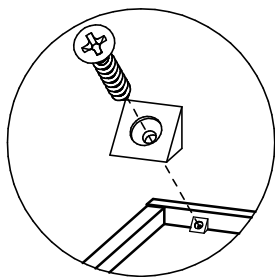

6

erstellt		geändert		geprüft	
Datum: 16.07.10		Datum:		Datum: 25.08.10	

7.

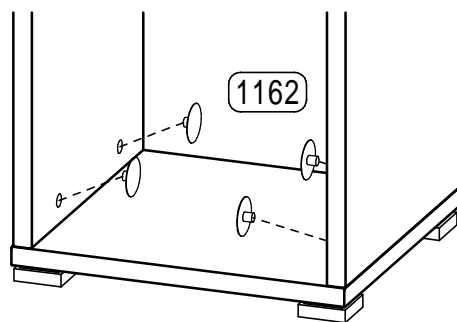
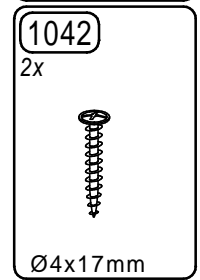
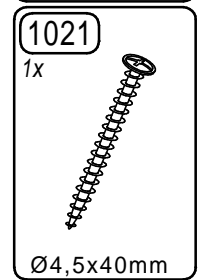
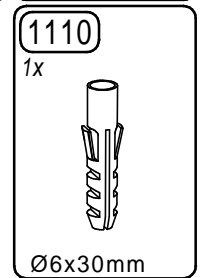
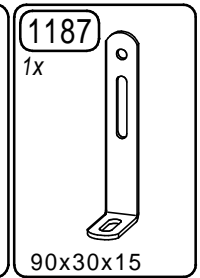
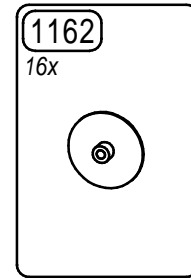
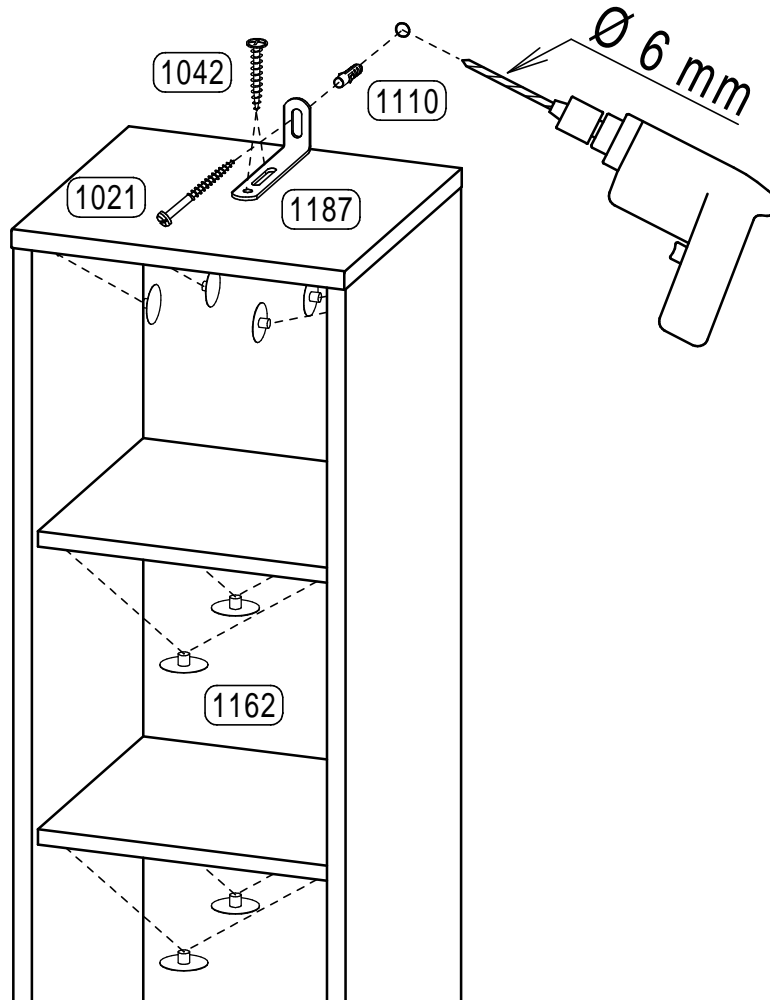

7

erstellt		geändert		geprüft	
Datum: 16.07.10		Datum:		Datum: 25.08.10	

Ersatzteil-Direkt Service

(nur für Deutschland - for germany only - seulement pour Allemagne)

Sehr geehrter Kunde,
sollte ein Möbelteil bzw. Beschlagteil fehlen oder beschädigt sein, senden Sie uns den Artikel bitte **nicht** zurück, sondern fordern Sie der Einfachheit halber Ersatz direkt bei **GERMANIA** an.

Tragen Sie Ihren Bedarf in die Tabelle ein und übermitteln Sie uns diese Seite per Post, per Fax, telefonisch oder per e-mail.
Bitte unbedingt die MODEL-Nr. + DEKOR-Nr. (siehe Karton) und die entsprechende Teilebezeichnung (siehe Teilleiste) angeben.

Mod. Nr.: _____ Dekor-Nr.: _____



1
2
3
4
Serie



Möbelteile			
Teil	beschäd.	fehlt	Anzahl
Z	X		1

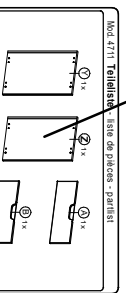

Beschlagteile			
Teil	beschäd.	fehlt	Anzahl
1162		X	2

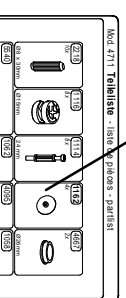

Absender nicht vergessen :

Name: _____ Strasse u. Nr.: _____
 PLZ: _____ Ort : _____
 Tel.: _____ Fax: _____ e-mail: _____

Unsere Hotline :

Tel. 05252 84939 und 05252 84962 Fax: 05252 84936

e-mail : service@mygermania.com
GERMANIA - Service - Postfach 1160 D 33189 Schlangen

Sicherheitshinweise Safety instructions Indications de sécurité

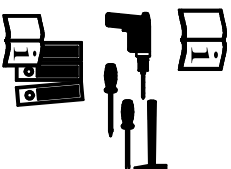

- 1.) Montageanleitung aufmerksam durchlesen
Please read assembly instruction carefully
Prière de bien lire la notice de montage du début à la fin
- 2.) Montage nach Montageanleitung durchführen
Please follow the assembly instruction step by step
Bien suivre le sens du montage indiqué sur la notice
- 3.) Montageanleitung aufbewahren
Please save the assembly instruction
Bien conserver la notice de montage



ACHTUNG! Beschlagbeutel und Beschlagteile von Säuglingen und Kindern fernhalten
ATTENTION! To avoid suffocation keep plastic bag away from children
 Certains small parts which may be a choking hazard
ATTENTION! Toutes les pièces détachées livrées dans le colis être mis hors de portée des bébés, des et enfants

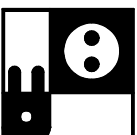
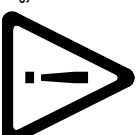

Netzanschluss (230V) nur von einem Fachmann ausführen lassen.
 Sanitäranschluss nur von einem Fachmann ausführen lassen.
 Mains connection (230V) has to be done by an expert.
 Sanitary installation has to be done by an expert.
 L'électricité (230V) uniquement à faire par un électricien.
 Installation sanitaire à faire par un spécialiste.

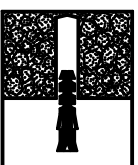
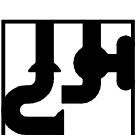

Beiliegendes Befestigungsmaterial eignet sich nur für Massivwände.
 Für andere Wände müssen Spezialdübel verwendet werden.
 Die Festigkeit ist zu Prüfen.
 The attached fixing materials is only suitable for solid walls.
 For other Types of walls special dowels have to be used.
 The firmness have to be checked.
 Le matériel de fixation ci-joint est exclusivement prévu pour des murs pleins! (une fixation spéciale est nécessaire pour cloisons placo...).
 La fermeté est à examiner.

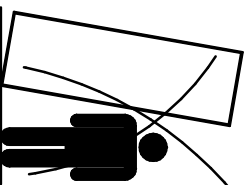

Beiliegende Wandbefestigungen dienen als Kippschutz,
 unbedingt anbringen!
 The attached wall fixing is necessary to avoid tipping
 and must be fixed!
 Les fixations prévues dans le colis
 préviennent contre le renversement du
 meuble. Il faut impérativement fixer le
 meuble au mur, afin d'éviter tout incident!

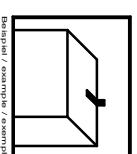

Für Schäden, die durch unsachgemäße Montage entstanden sind, übernehmen wir keine Haftung
 For the damages, which have originated from improper assembly, we take over no liability.
 Pour les dommages qui sont nés par le montage incorrect, nous ne prenons en charge aucune responsabilité.