

Modellname: **FLY**  
 Nazwa modelu:

Modellreihe: **23 -- FL**  
 Numer modelu:

Type: **20**  
 Typ:

Blatt Nr **1** von: **5**  
 Strona z:

# MONTAGEANLEITUNG INSTRUKCJA MONTAŻOWA

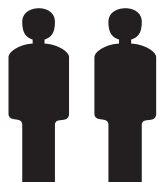
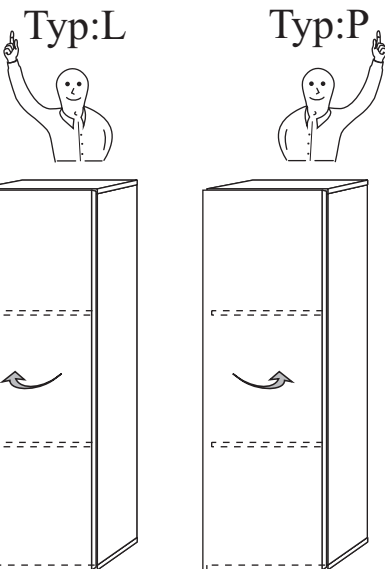

**2 Personen**  
**2 Osoby**

### Pflegehinweis!

Bitte nur mit einem Staubtuch oder einem feuchten Lappen reinigen.  
**KEINE** scheuernde Putzmittel verwenden!

### Wskazówka dotycząca pielęgnacji!

Proszę czyścić tylko suchą lub lekko wilgotną szmatką do kurzu. Nie używać żadnych środków szorstkich!

Max. zulässige Belastungen  
 von Einlegeböden in kg:

Maksymalne obciążenie półek w kg:

| Stärke/Gr.   | Spanplatte/Płyta |    |    |
|--------------|------------------|----|----|
| Länge/Dł. mm | 15               | 18 | 22 |
| 0<400        |                  |    |    |
| 401<600      | 40               | 40 | 40 |
| 601<800      | 24               |    |    |
| 801<1000     | 15               | 30 |    |

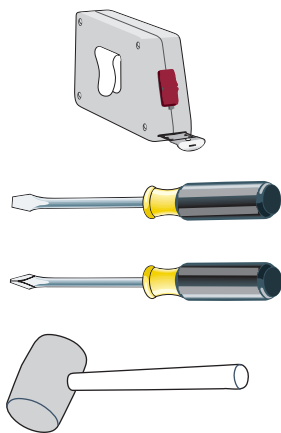
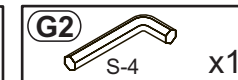
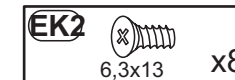
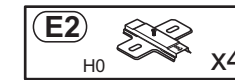
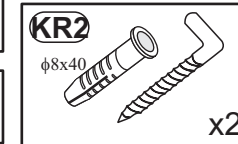
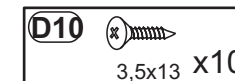
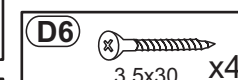
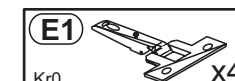
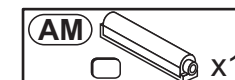
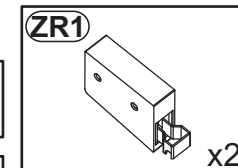
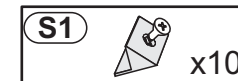
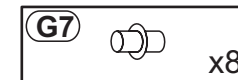
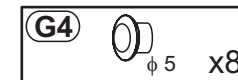
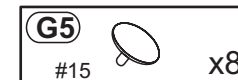
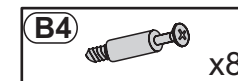
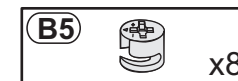
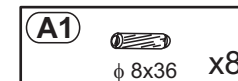
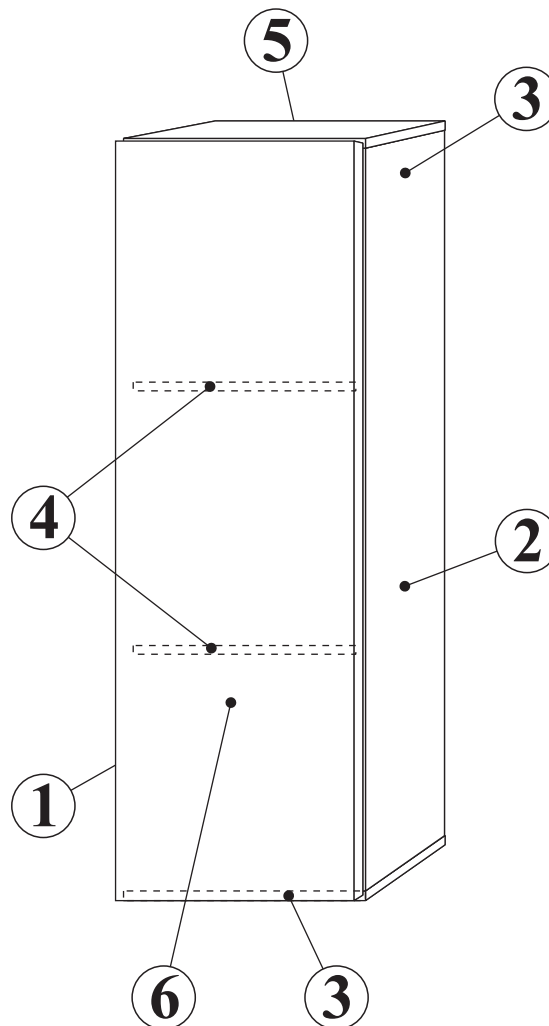

Modellname: **FLY**  
Nazwa modelu:

Modellreihe: **23 -- FL**  
Numer modelu:

Type: **20**  
Typ:

Blatt Nr **2** von: **5**  
Strona **2** z: **5**

**1**

Typ:L

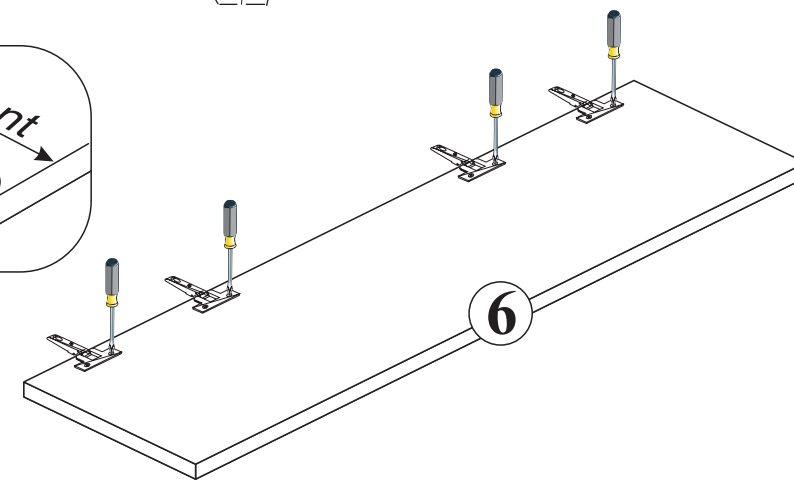
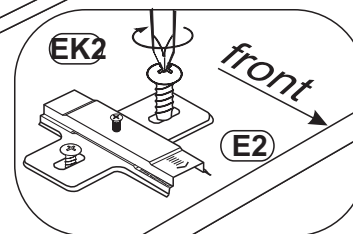
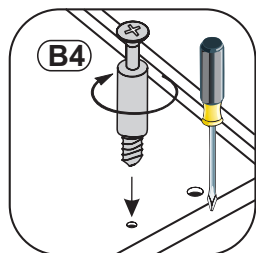
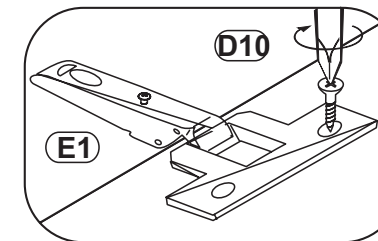
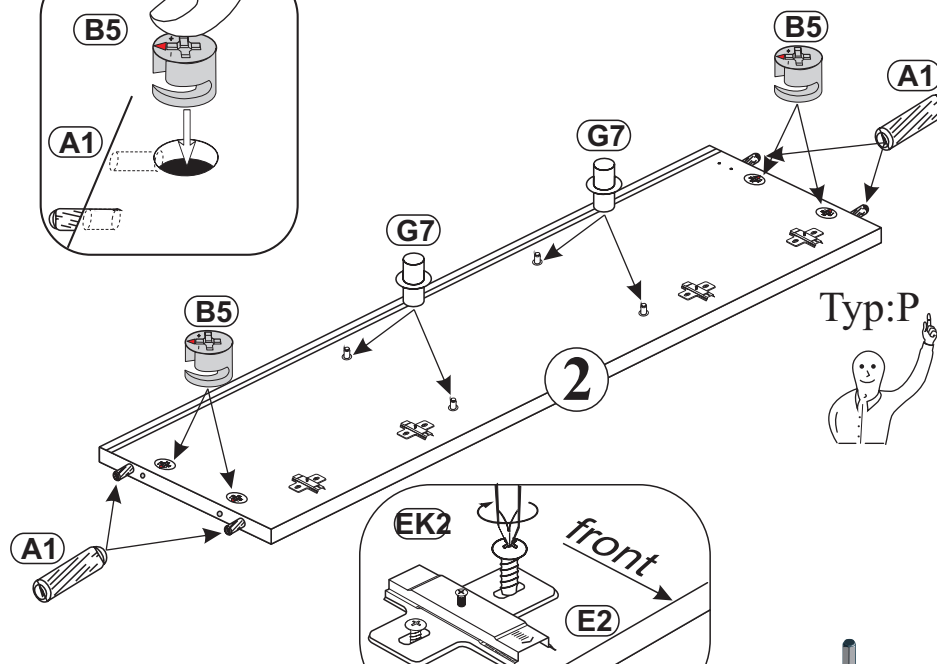
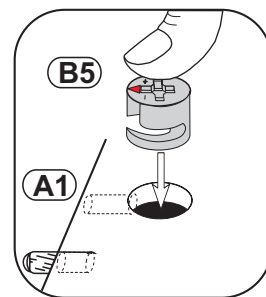
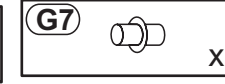
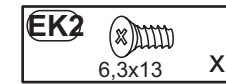
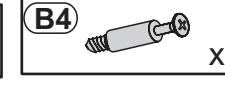
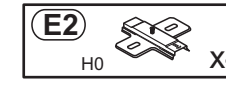
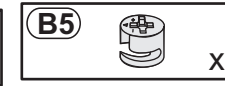
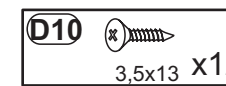
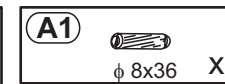
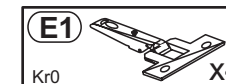
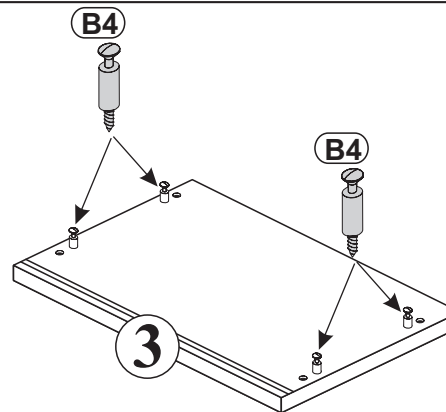
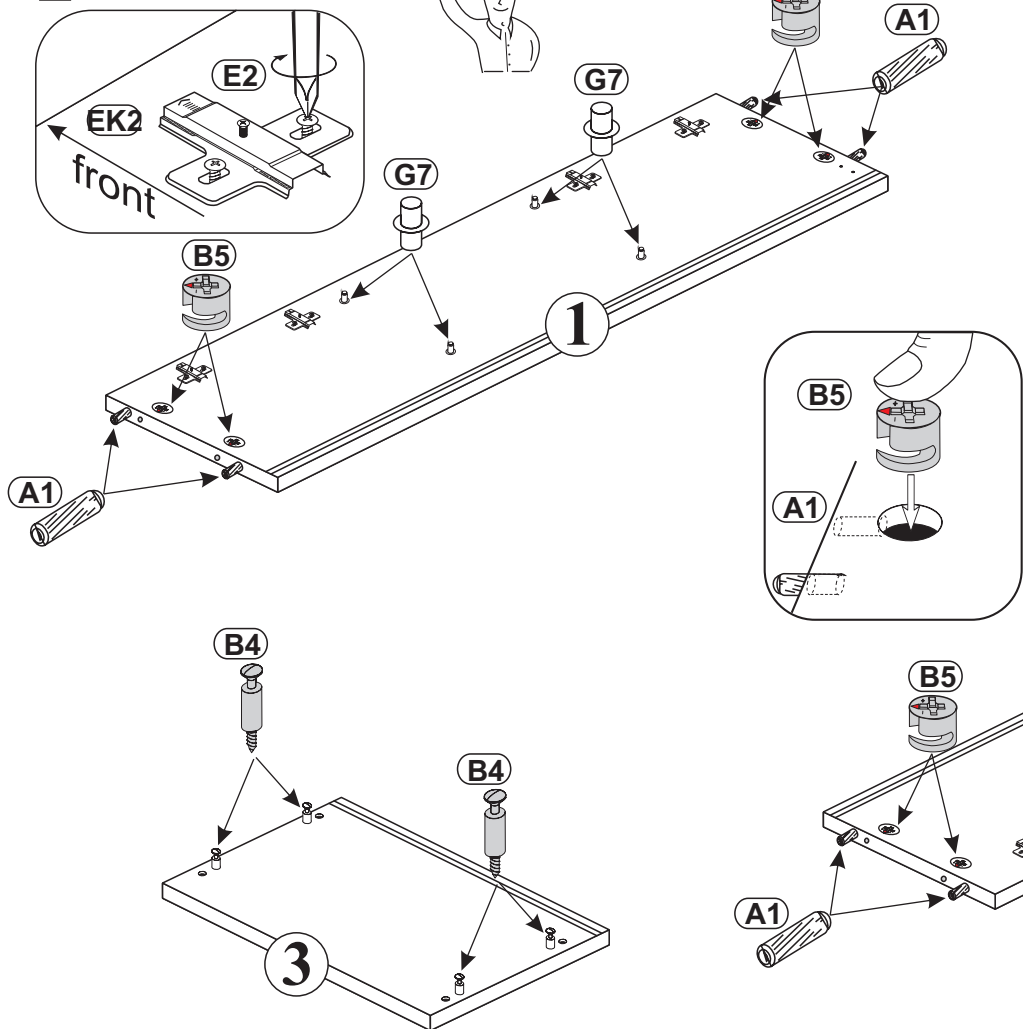

**2**

Typ:L

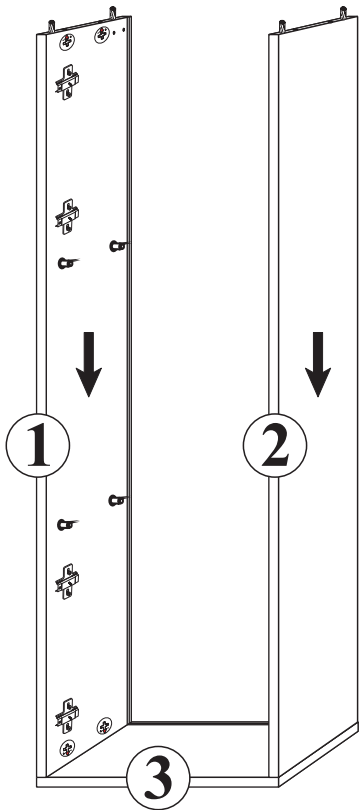

Typ:P

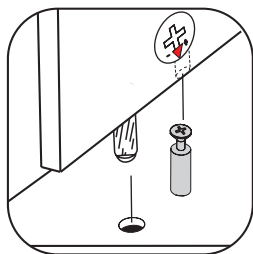
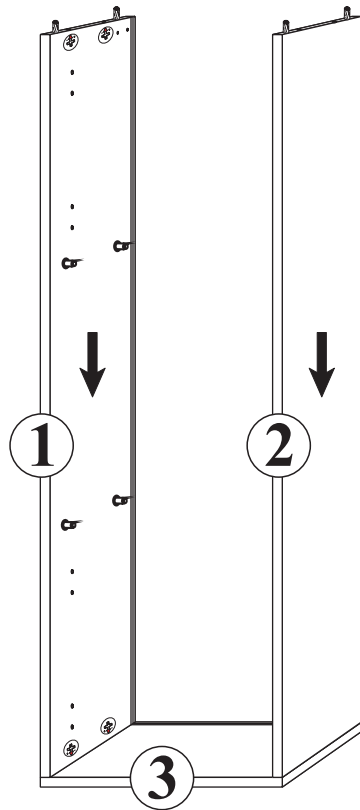

**3**

Typ:L

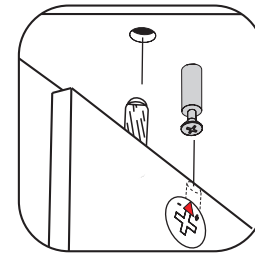
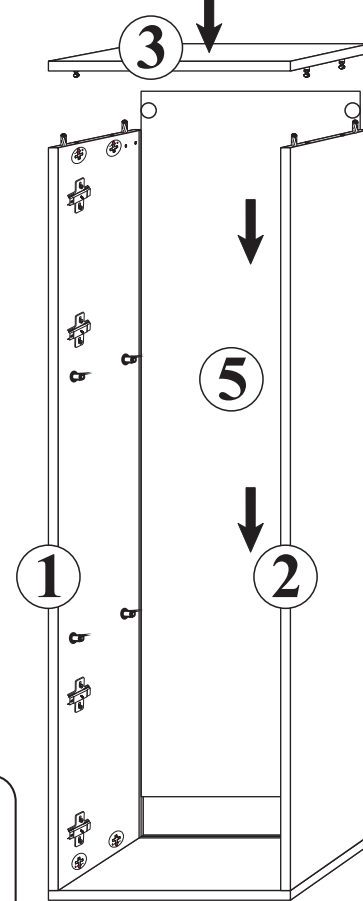

Typ:P

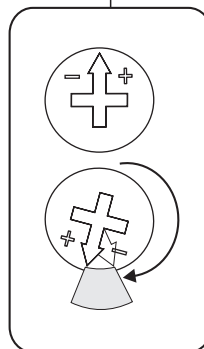
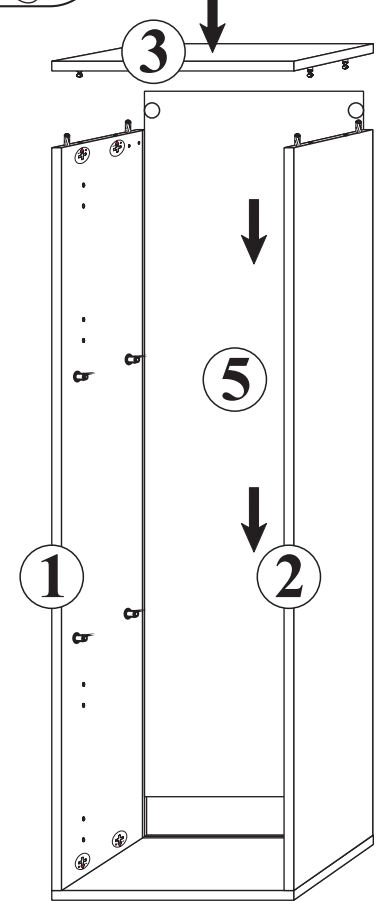

**4**



**a=b**

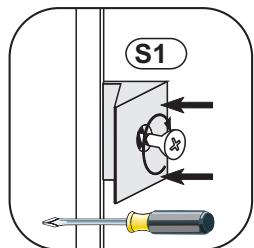
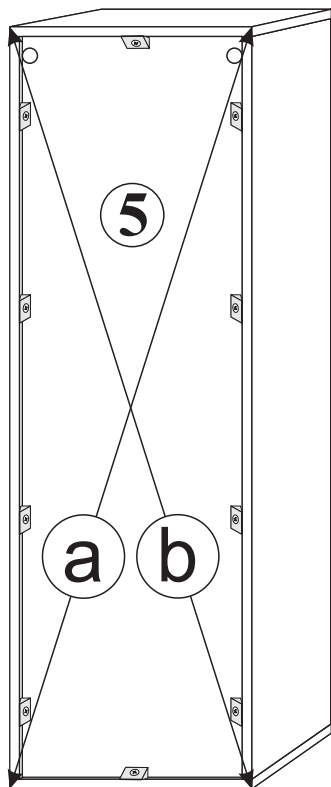

**5**

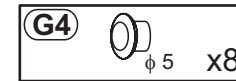
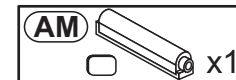
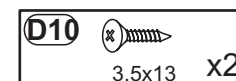
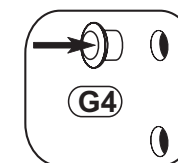
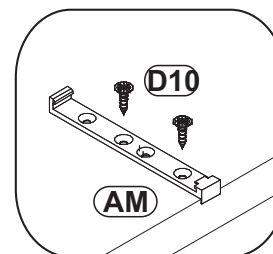
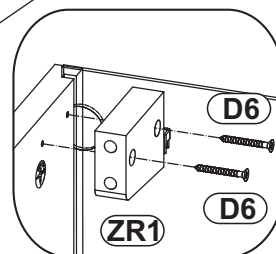
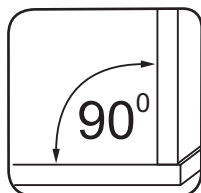
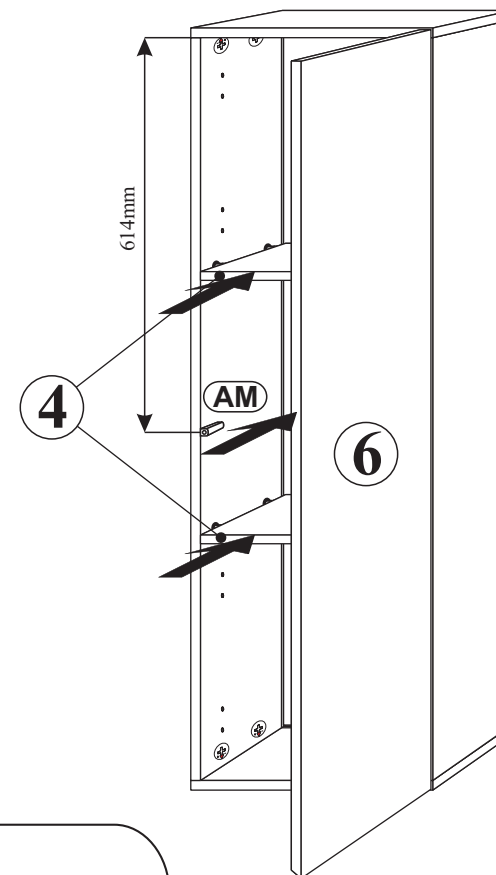
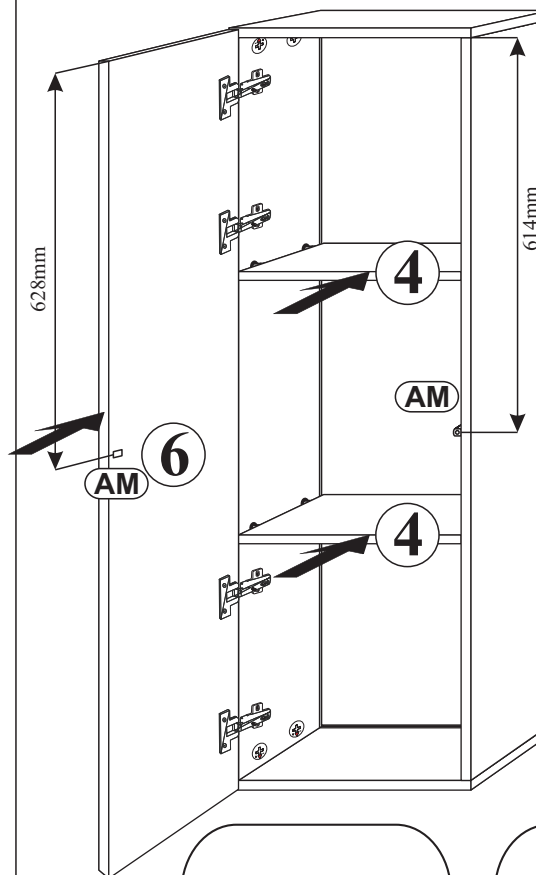
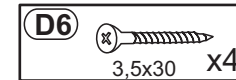
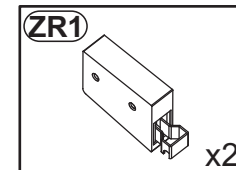
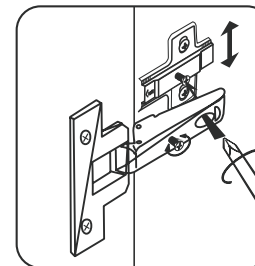
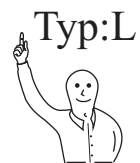

**6**

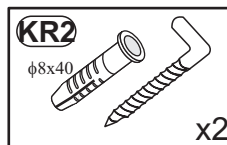
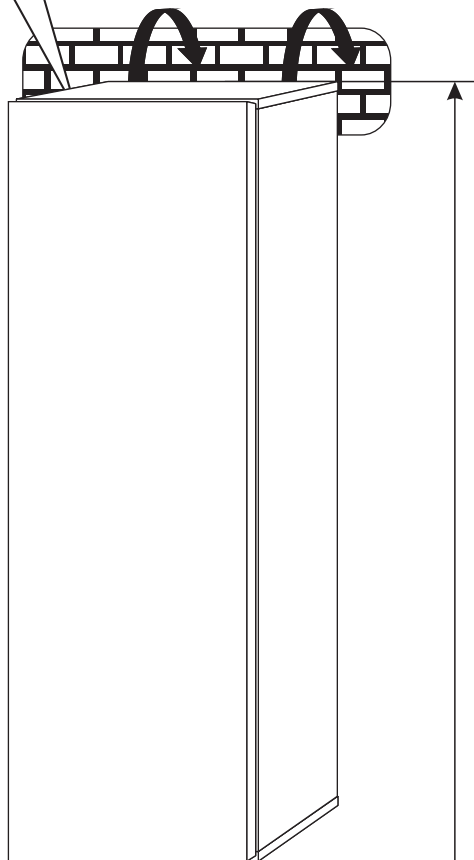
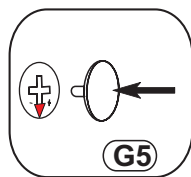
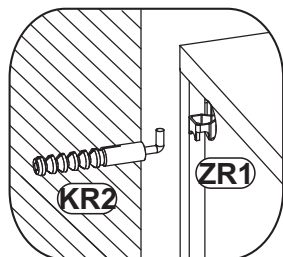

**PL**

Załączone kołki do zawieszania bryty, do stosowania wyłącznie do ścian betonowych, do innych ścian należy odpowiednio dokupić.

**D**

Die beigefügten Dübel zum Aufhängen des Elements dürfen nur bei Betonwänden eingesetzt werden, bei anderen Wandarten müssen entsprechende Dübel zugekauft werden.

## Verstellmöglichkeiten

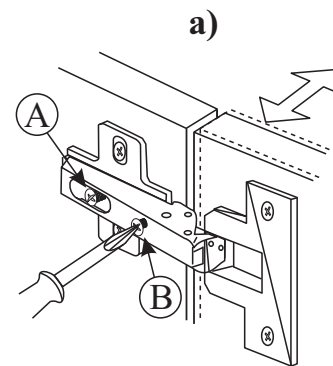

a) Fugenverstellung:  
Befestigungsschraube "A" lockern, gewünschte Fuge mit Schraube "B" einstellen, Schraube "A" anziehen.

b) Tiefenverstellung:  
Befestigungsschraube "A" lockern, Bandarm nach vorne oder rückwärts verschieben, Schraube "A" anziehen, Schraube "B" mit einer 1/4 Drehung nach rechts arretieren.

c) Höhenverstellung:  
Befestigungsschraube "C" lockern, Höhe einstellen, Schraube "C" anziehen.

## Instructions for hinge adjustment

a) Side adjustment:  
Loosen fixing screw "A", adjust gap with screw "B" and retighten screw "A".

b) Depth adjustment:  
Loosen fixing screw "A", push hinge arm forwards or backwards, retighten screw "A", fix screw "B" with a 1/4-turn in clock-wise direction.

c) Height adjustment:  
Loosen screw "C", adjust height, retighten screw "C".

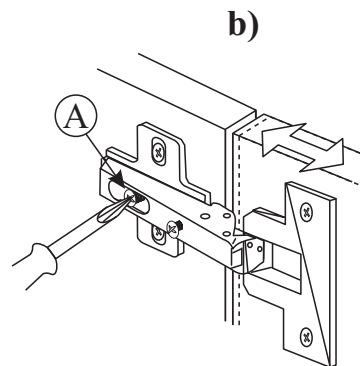

## Les possibilités de positionnement

a) Positionnement de la rainure:  
Desserrer la vis de fixation "A", positionner avec la vis "B" la rainure (joint) souhaitée et resserrer la vis "A".

b) Positionnement de la profondeur:  
Desserrer la vis de fixation "A" (1 tour), régler la profondeur et resserrer la vis "A".

c) Positionnement de la hauteur:  
Desserrer la vis de fixation "C" (1 tour), positionner la hauteur et resserrer la vis "C".

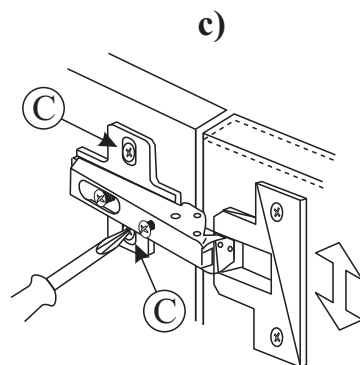

## Możliwości regulacji

a) Regulacja szczeliny:  
Poluzować wkręt "A", wkrętem "B" ustawić odpowiednią szczelinę, dokręcić wkręt "A".

b) Regulacja głębokości:  
Poluzować wkręt "A" (1 obrót), ustawić głębokość, dokręcić wkręt "A".

c) Regulacja wysokości:  
Poluzować wkręt "C" (1 obrót), dokonać regulacji wysokości położenia drzwi, wkręt "C" dokręcić.