

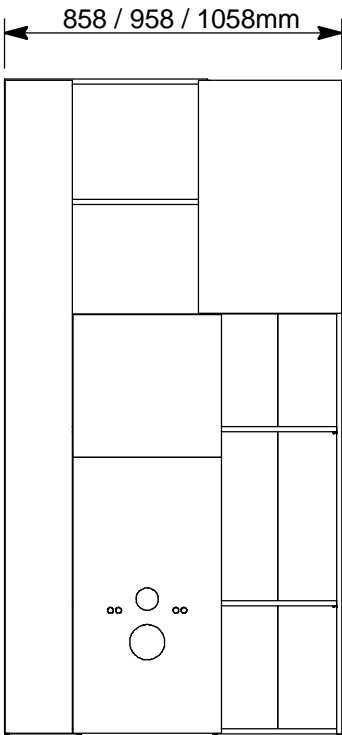

# ENTOURAGE WC

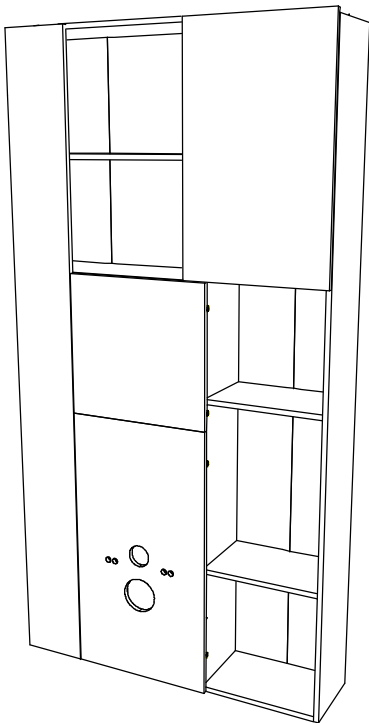

205,5cm  
80 29/32"

85.8 / 95.8 / 105.8cm  
33 25/32" / 37 23/32" / 41 31/32"

26.6cm  
10 15/32"

### FR Remerciements :

Nous vous remercions d'avoir choisi un meuble créé et fabriqué par le Groupe Parisot et espérons qu'il vous donnera entière satisfaction.

### EN Thanks:

Thank you for choosing furniture designed and manufactured by the Parisot Group. We hope you are totally satisfied with your purchase.

### DE Danksagung:

Wir danken Ihnen für den Kauf eines Frankreich von der Parisot-Gruppe entworfenen und hergestellten Möbelstücks und hoffen, dass Sie es zu Ihrer vollkommenen Zufriedenheit finden werden.

### ES Agradecimientos:

Les damos las gracias por haber elegido un mueble diseñado y fabricado por el Groupe Parisot y esperamos que sea de su total agrado.

### PT Agradecimentos:

Obrigado por ter escolhido um móvel concebido e fabricado pelo Grupo Parisot, esperando que seja do seu inteiro agrado.

### IT Ringraziamenti:

Grazie per avere scelto un mobile progettato e fabbricato dal Gruppo Parisot. Speriamo soddisfatti appieno le vostre esigenze.

### NL Bedankje:

Wij bedanken u voor de aankoop van een door de Groep Parisot ontworpen en vervaardigd meubel en hopen dat u er veel plezier aan zult beleven.

### CZ Poděkování:

Děkujeme, že jste si vybrali nábytek navržený a vyrobený společností Parisot Group. Doufáme, že budete svým nákupem naprosto spokojeni.

### HU Köszönet.

Köszönjük, hogy a Parisot Groupe által létrehozott és gyártott bútort választott, reméljük, hogy elégedett lesz a termékkel.

### PL Podziękowania:

Dziękujemy za wybór mebli stworzonych i wyprodukowanych przez Grupę Parisot. Mamy nadzieję, że będziecie Państwo w pełni zadowoleni z zakupu.

### RO Mulțumiri:

Vă mulțumim că ați ales un articol de mobilier conceput și fabricat de Grupul Parisot și sperăm că veți fi pe deplin satisfăcuți de acesta.

### RU Благодарность:

Мы благодарим вас за то, что вы выбрали мебель, созданную и произведенную Групп Паризо, и надеемся, что вы будете полностью довольны нашей продукцией.

### SK Pod'akovanie:

Ďakujeme, že ste si vybrali nábytok navrhnutý a vyrobený spoločnosťou Parisot Group. Dúfame, že budete svojím nákupom absolútne spokojní.

### TR Teşekkür ederiz:

Parisot Group tarafından tasarlanan ve üretilen bu mobilyayı seçtiğiniz için teşekkür ederiz. Ürünümüzden memnun kalmanızı ümit ederiz.

### AR شكر:

نشكركم لاختياركم هذه القطعة من الأثاث من تصميم وتصنيع مجموعة باريسو Parisot ونتمنى أن تتلوا رضاهكم.

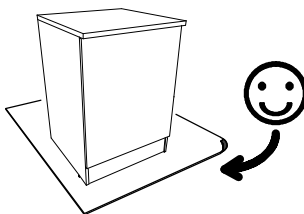
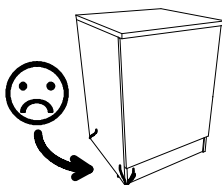
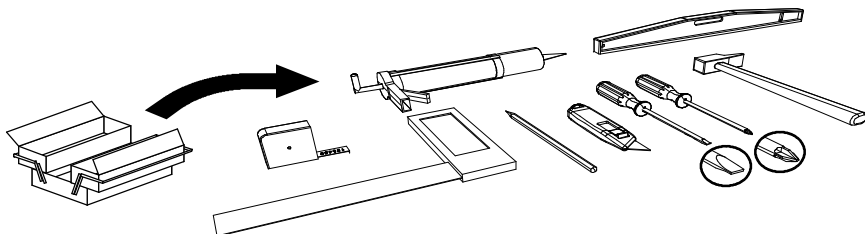

[contact@parisot.com](mailto:contact@parisot.com)





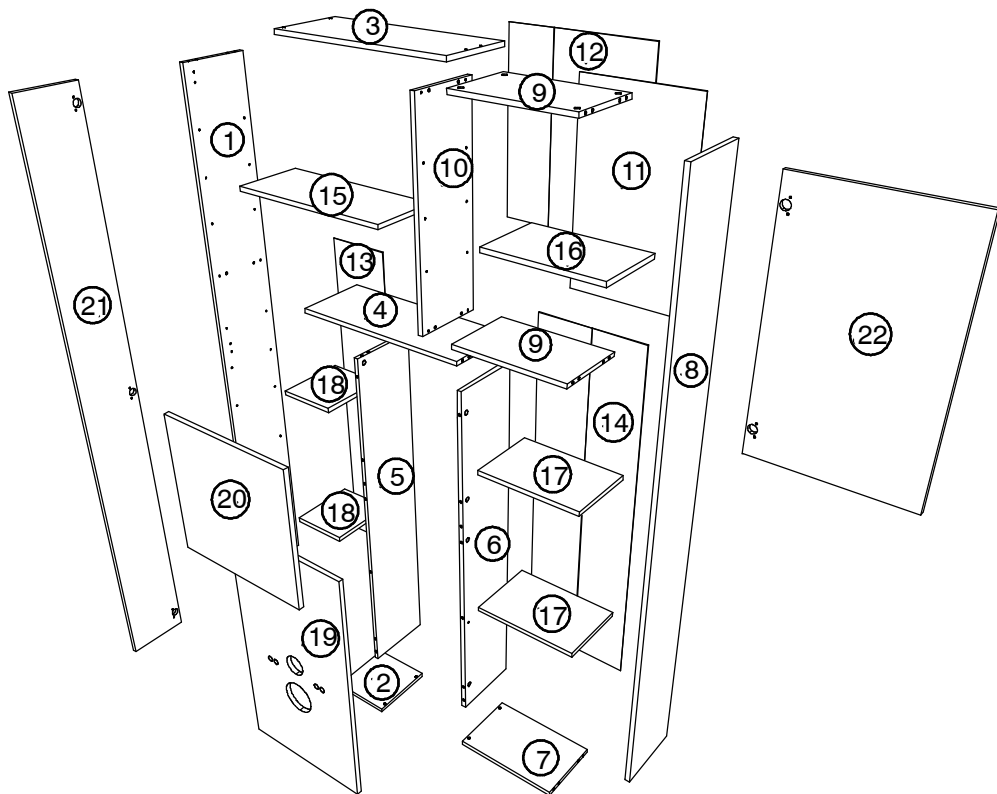





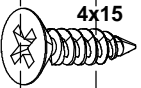
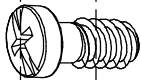
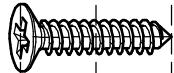
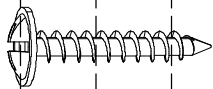
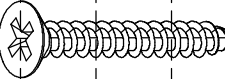

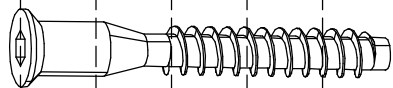

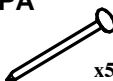

[www.parisot.com](http://www.parisot.com)

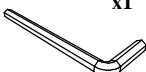

Ref	Q	Longueur	largeur	Epais.
01	1	2035mm	249,5mm	16mm
02	1	226,5mm	249mm	16mm
03	1	636mm	250mm	16mm
04	1	636mm	249mm	16mm
05	1	1282,5mm	248,5mm	16mm
06	1	1299mm	249mm	16mm
07	1	390mm	249mm	16mm
08	1	2035mm	249,5mm	16mm
09	2	408mm	249mm	16mm
10	1	720mm	249mm	16mm
11	1	710mm	430mm	2,5mm
12	1	743mm	624mm	2,5mm
13	1	1305mm	241mm	2,5mm
14	1	1322mm	404mm	2,5mm
15	1	600,5mm	248mm	16mm
16	1	407mm	248mm	16mm
17	2	372,5mm	248mm	16mm
18	2	209mm	248mm	16mm
19	1	864mm	464mm	16mm
20	1	448mm	464mm	16mm
21	1	2046mm	210,5mm	16mm
22	1	731mm	449mm	16mm

0 1 cm 2 3 4 5

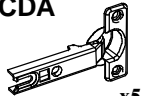
VAF8		4x15	x4
CDS			x20
WJ			x6
XN			x2
WF			x4
ADM			x26
HW			x6

FA 	PA 	BWD x24 
PAS 	HV 	PU 
AI 	BWC 	ZK 
BQS 	CDA 	CDD x5 

1

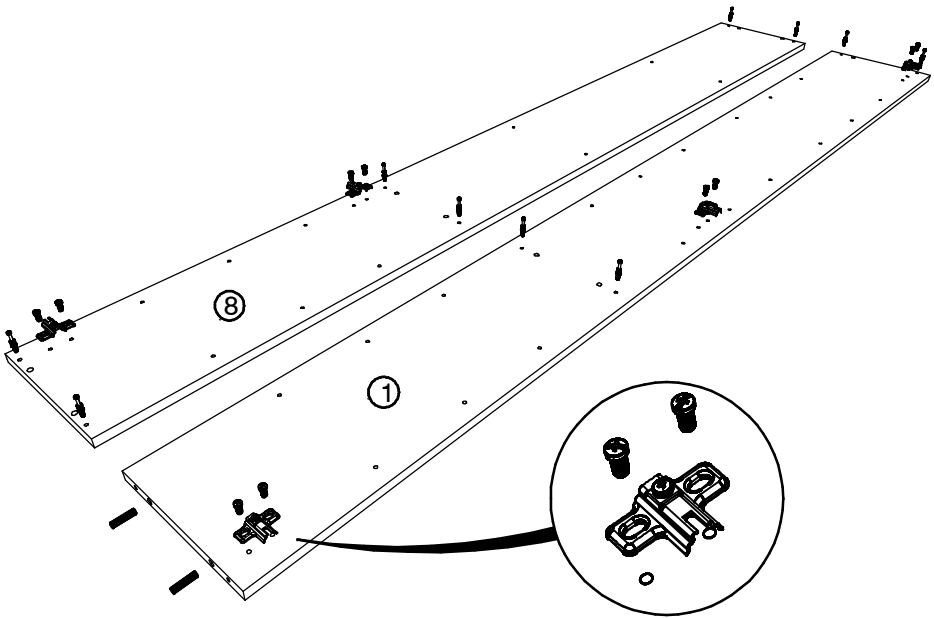
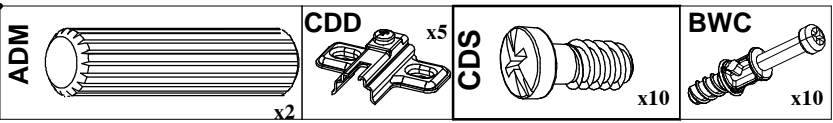

2

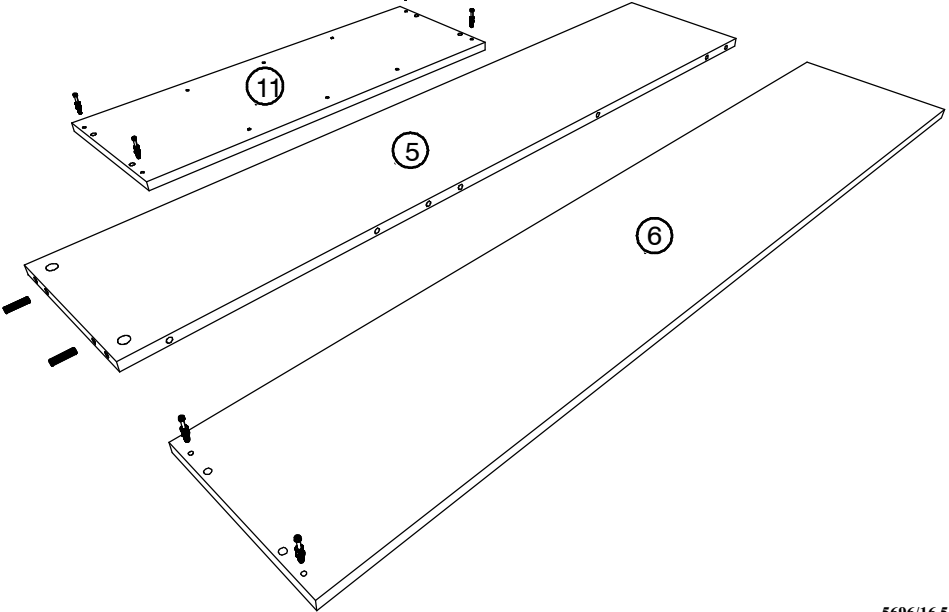

3

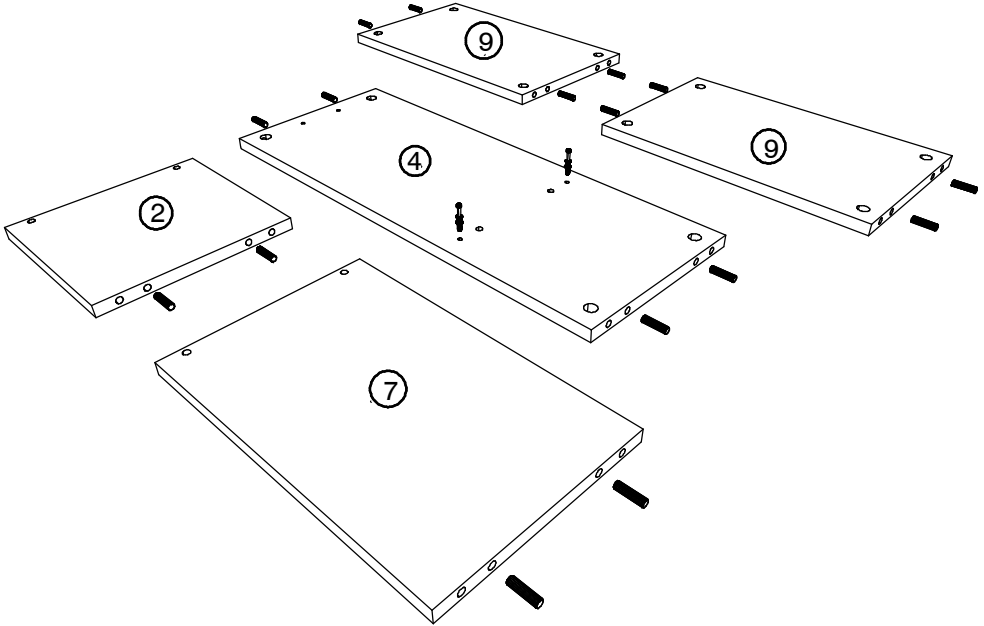
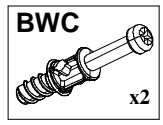
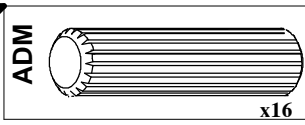

4

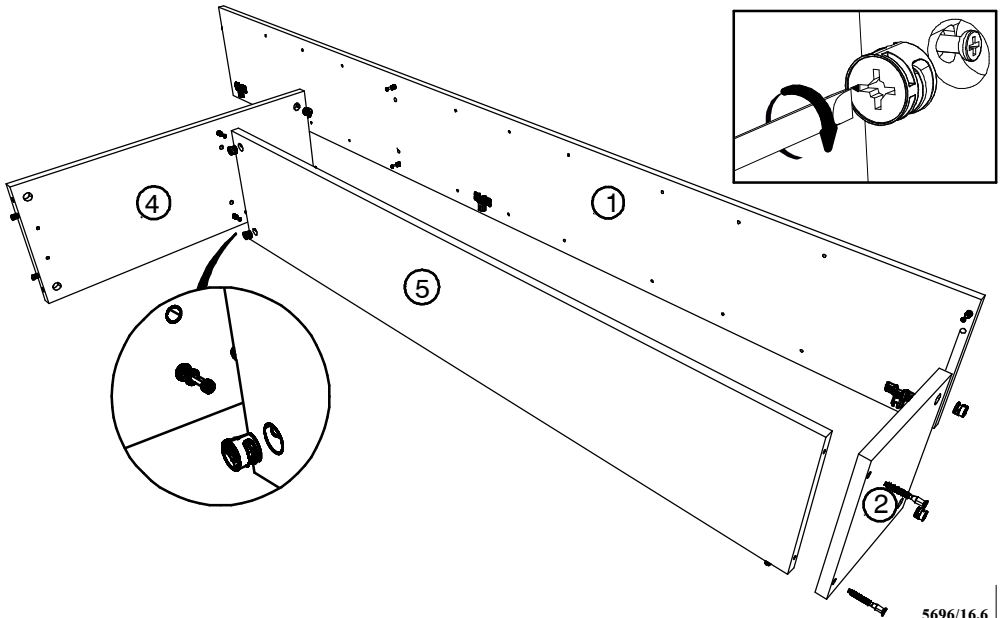
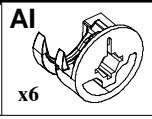
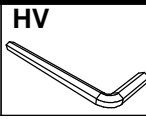
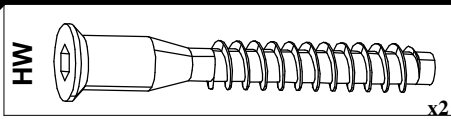

5

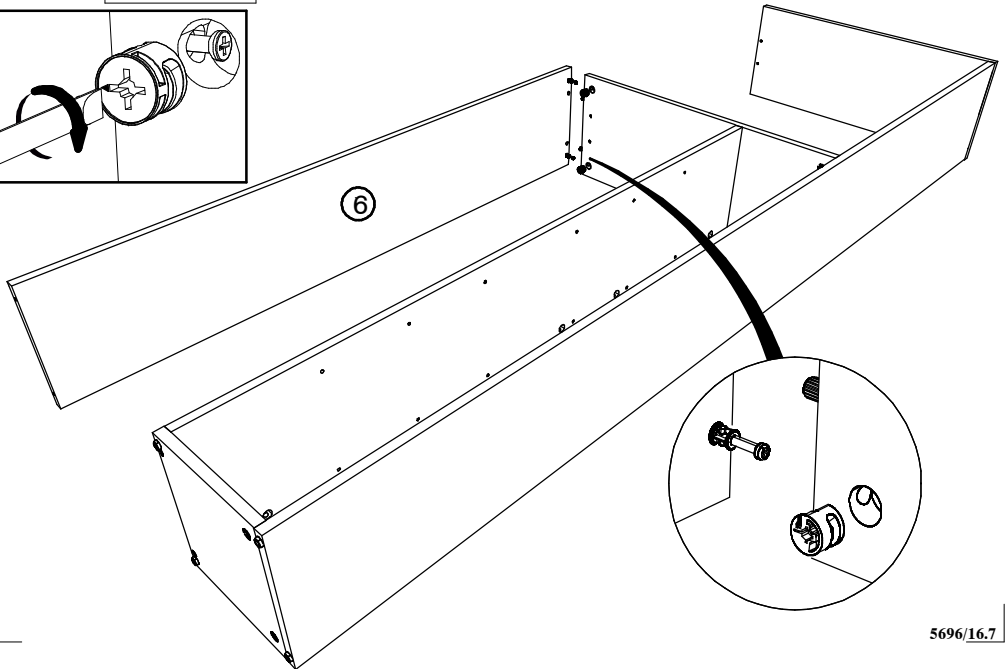
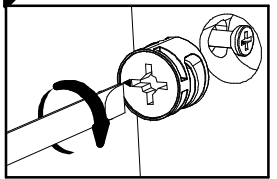
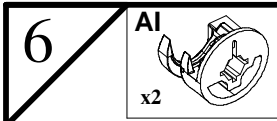
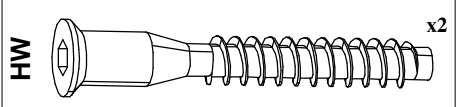
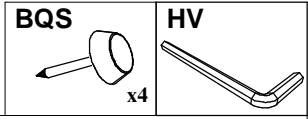
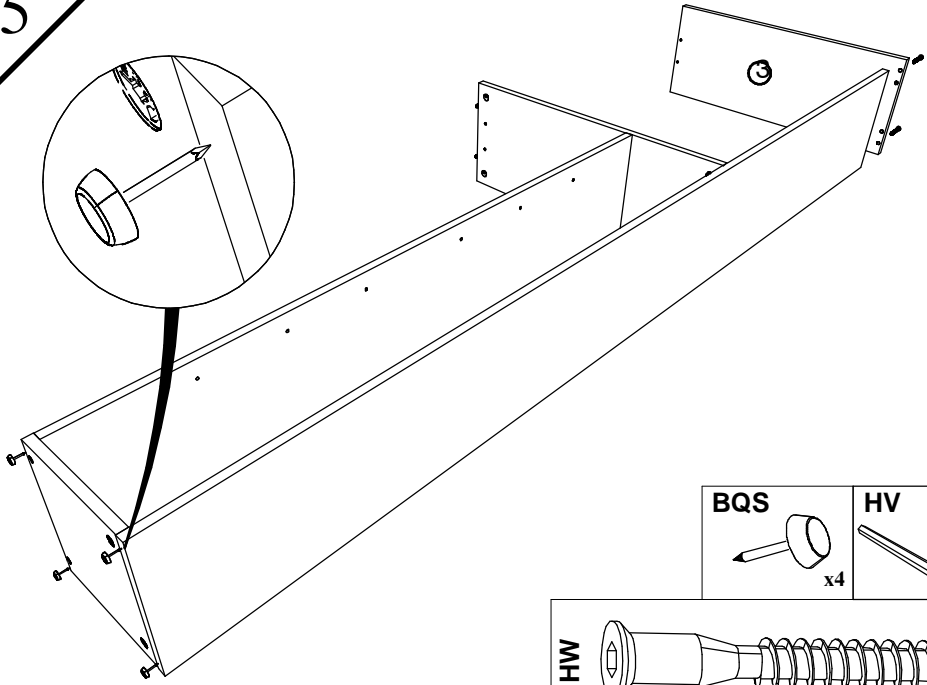

7

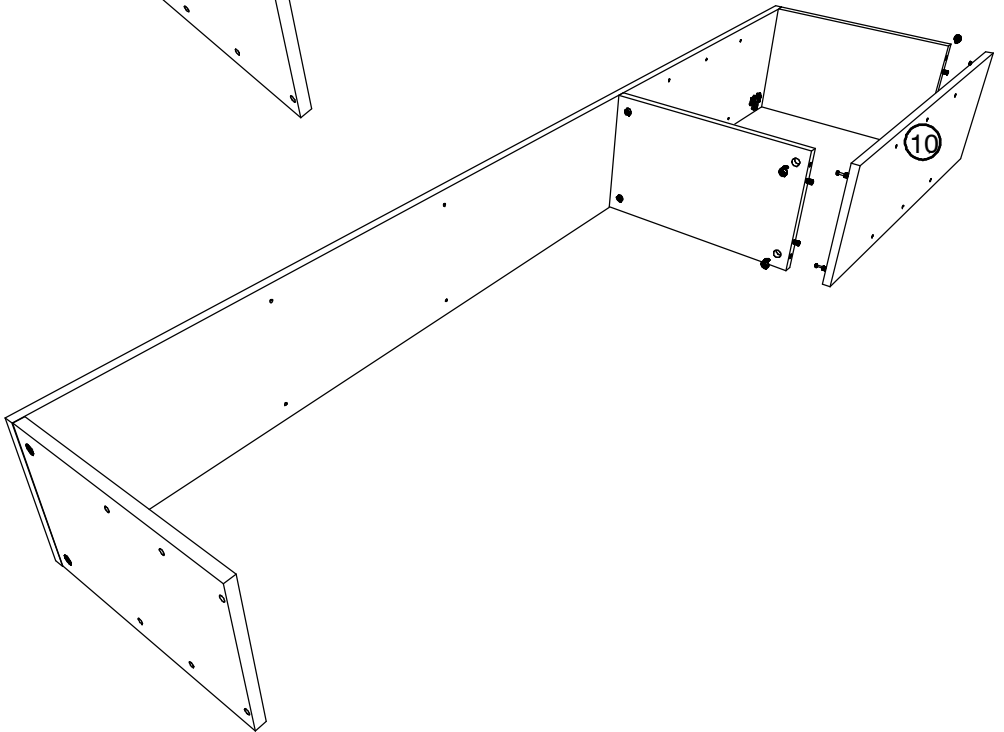
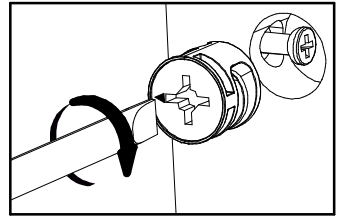
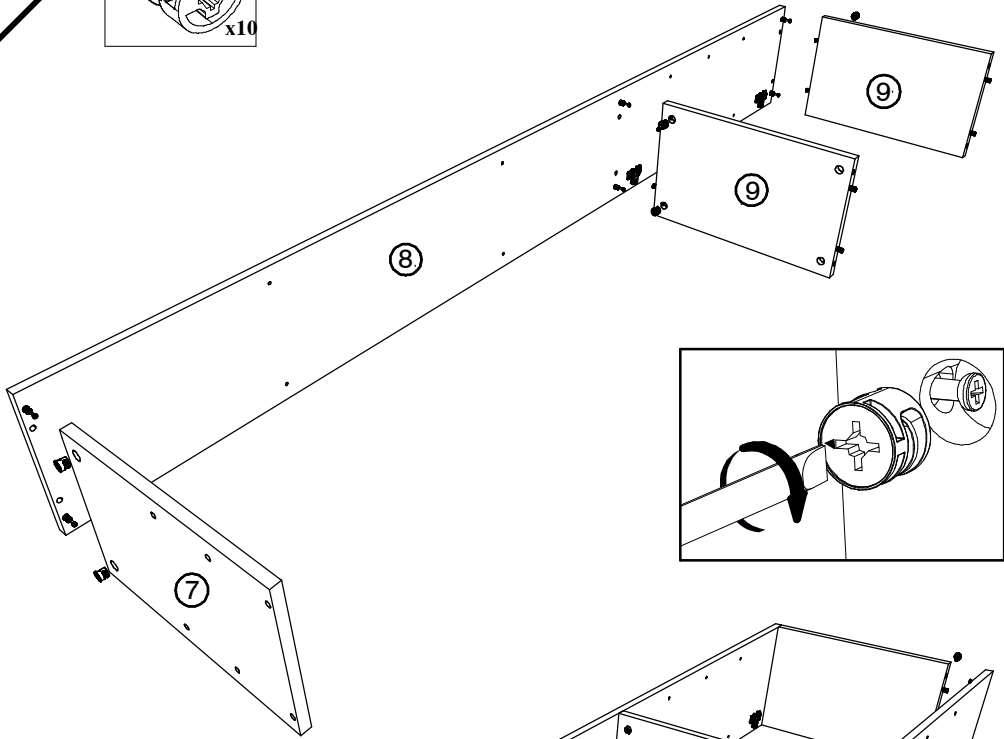
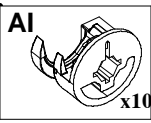



8

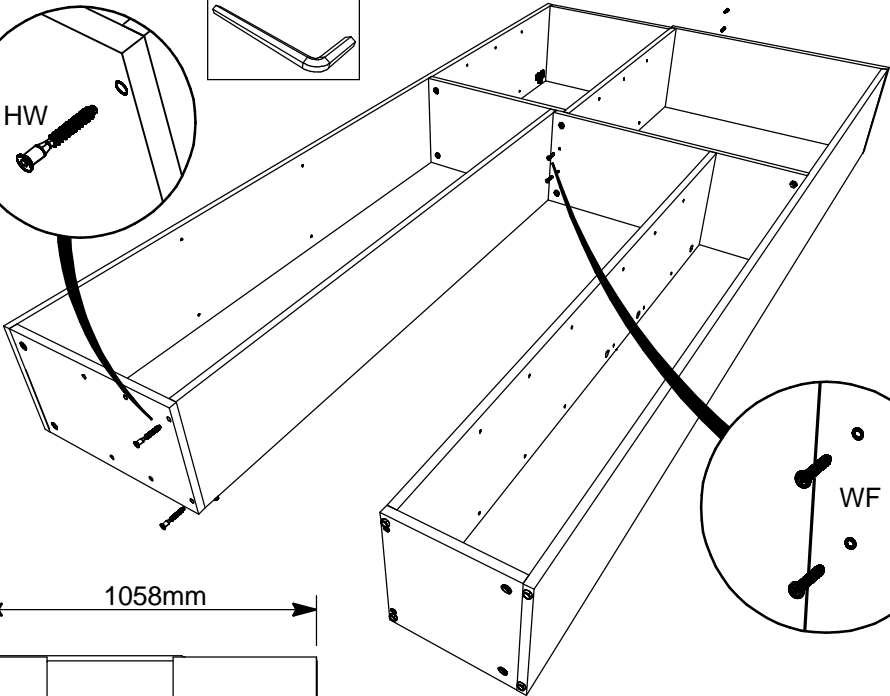
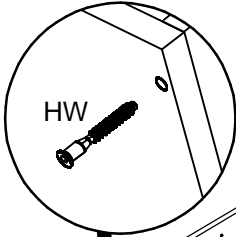
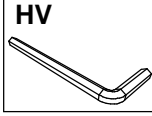
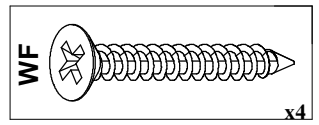
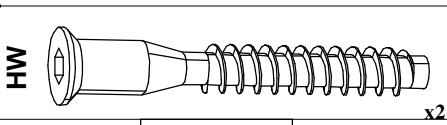

1058mm

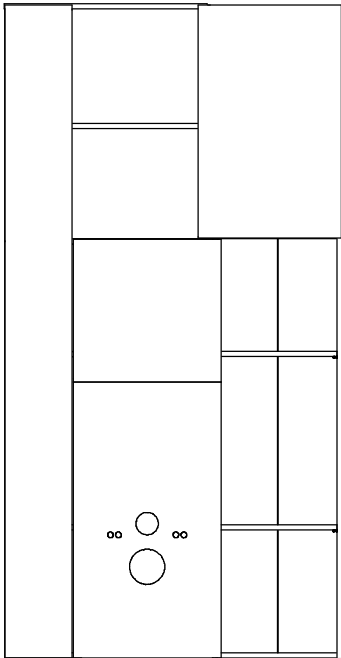

9

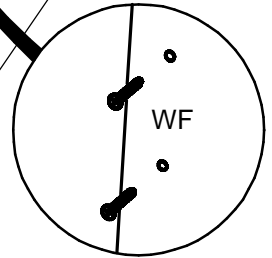
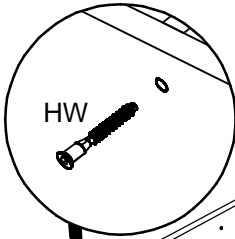
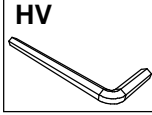
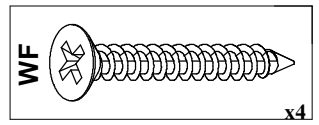
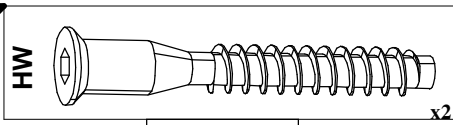

958mm

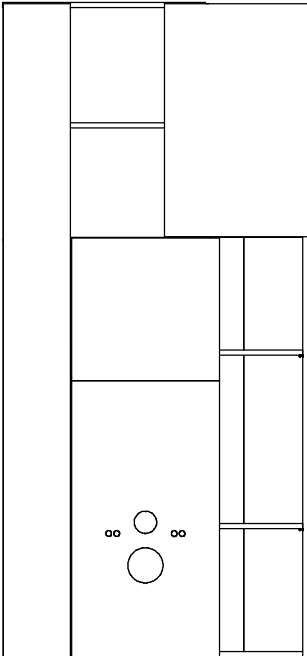

Déboucher les perçages de diamètre 8mm  
Puis recouper la partie qui dépasse

10

HW

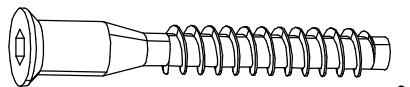

x2

WF

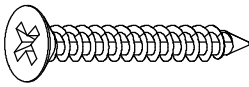

x4

HV

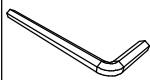

HW

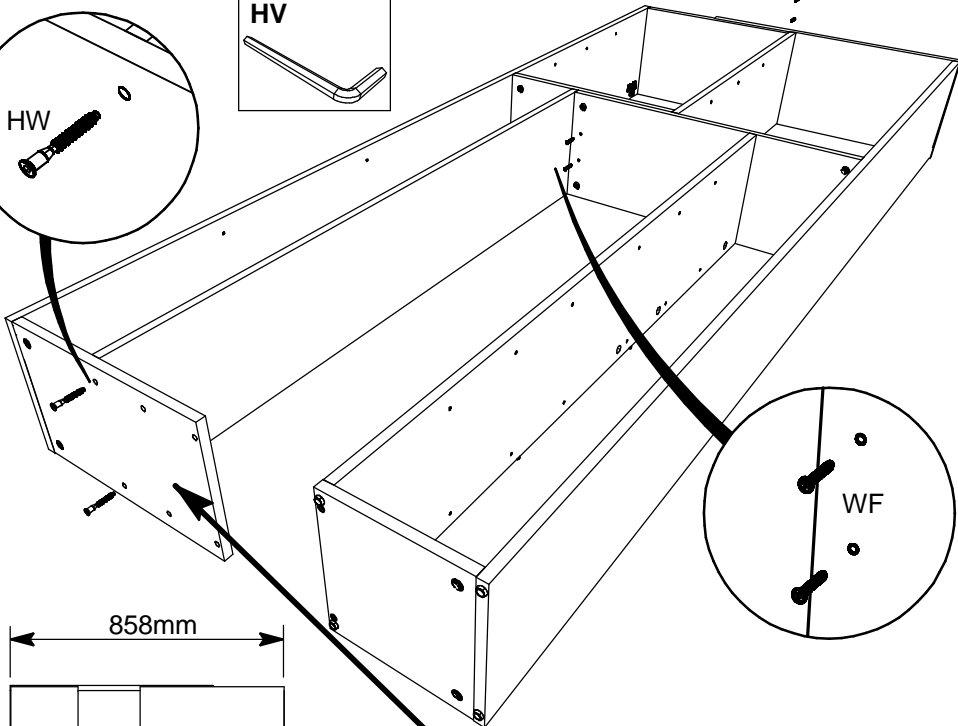

WF

858mm

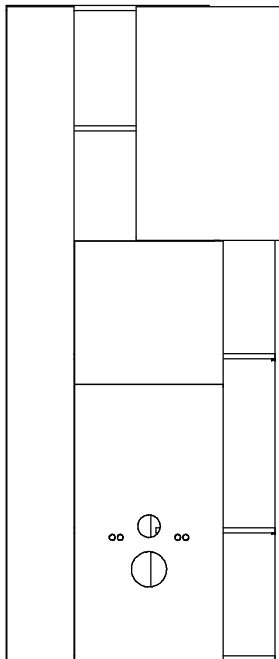

Déboucher les perçages de diamètre 8mm  
Puis recouper la partie qui dépasse

11

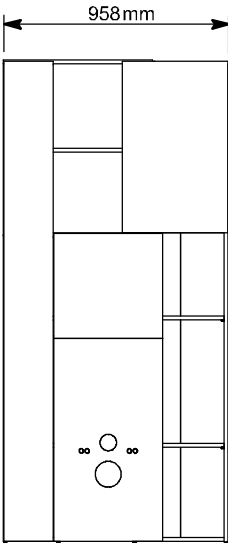
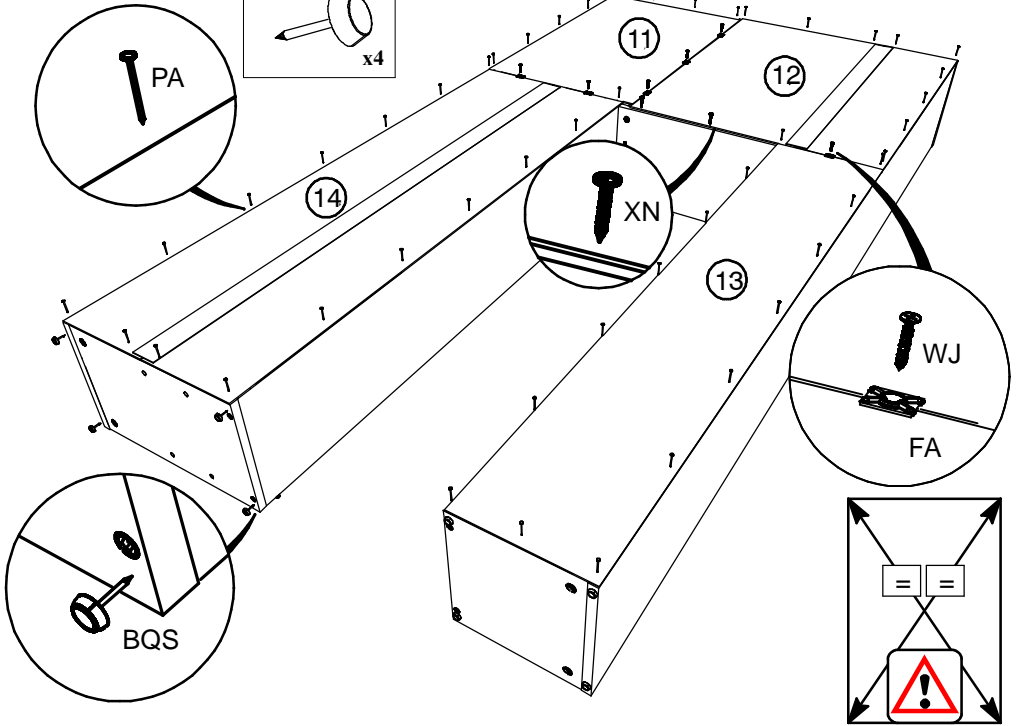
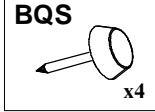
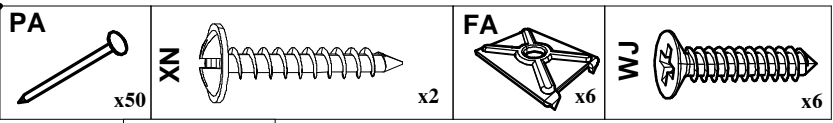

12 14 A recouper de 100 mm

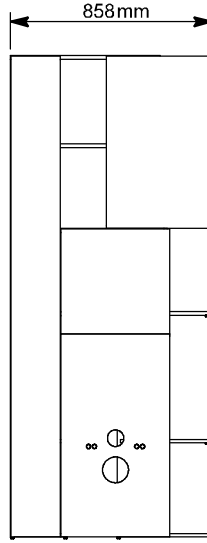

12 14 A recouper de 200 mm

12

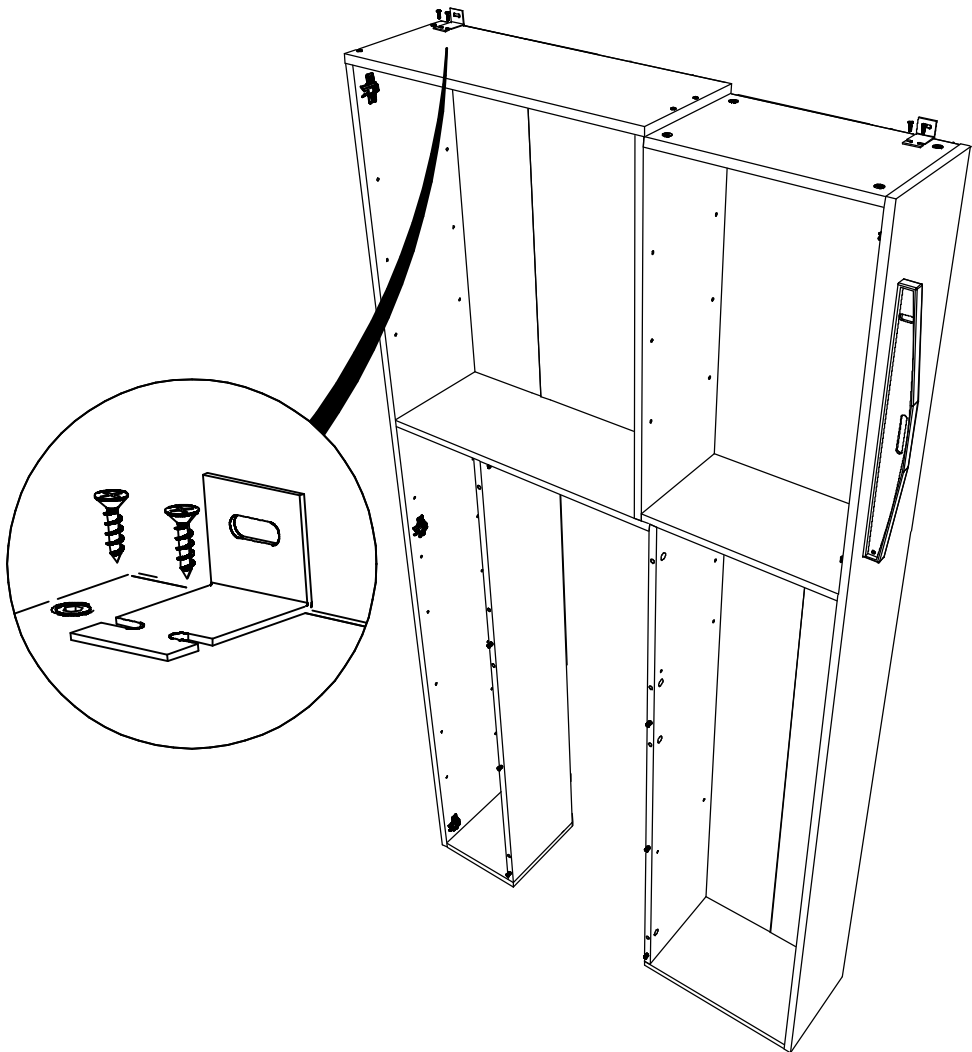
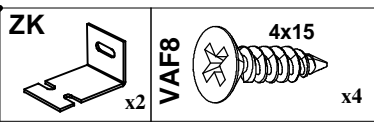

**UTILISER DES VIS ET DES CHEVILLES  
ADAPTEES A VOS MURS**



Il existe une grande diversité de type de murs ou cloisons, c'est la raison pour laquelle nous ne pouvons pas vous fournir une quincaillerie adaptée à votre mur. Il est nécessaire d'identifier le type de paroi à laquelle vous allez fixer ce produit afin de vous procurer les fixations appropriées. En cas de besoin, adressez vous à un magasin spécialisé pour conseil.





**FIXATION OBLIGATOIRE**

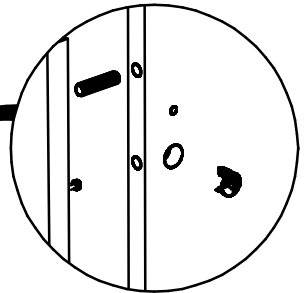
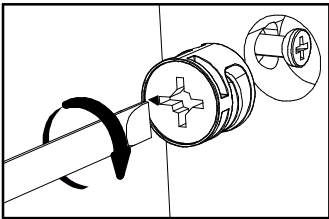
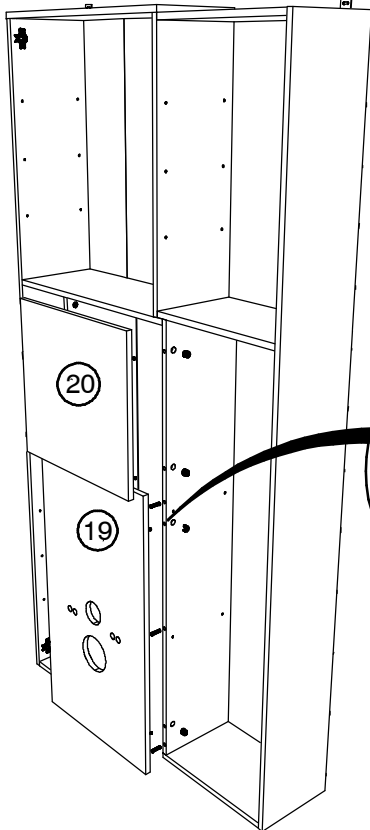
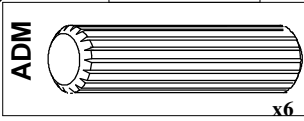
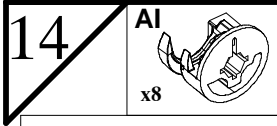
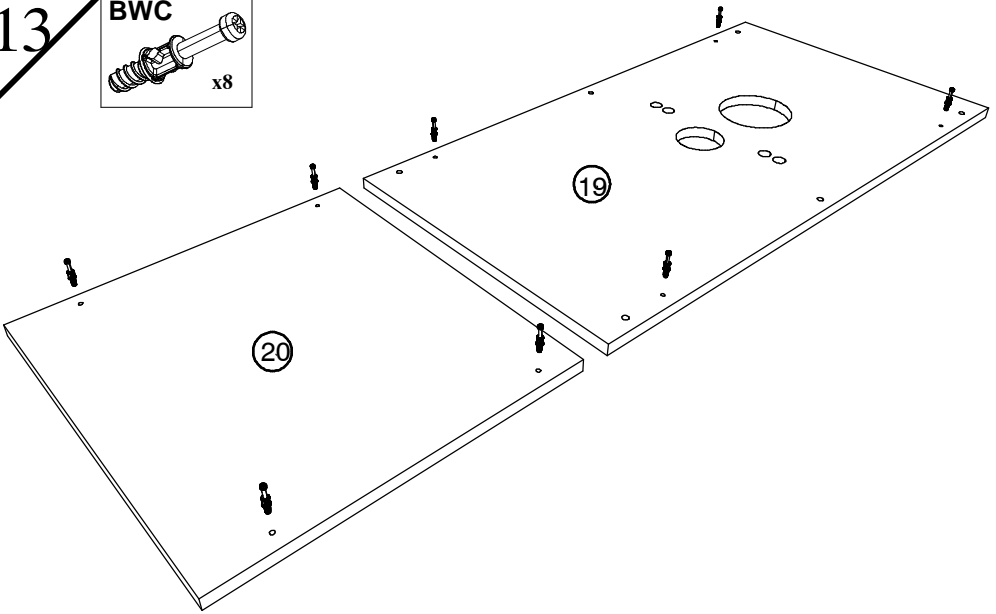
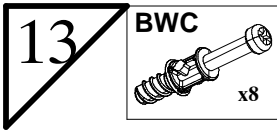

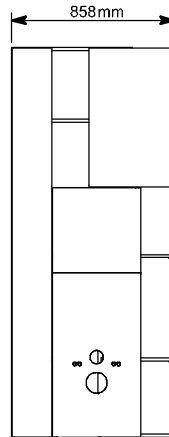
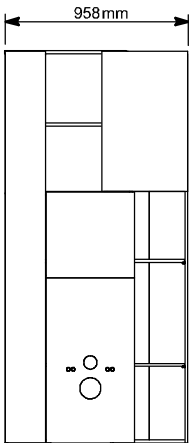
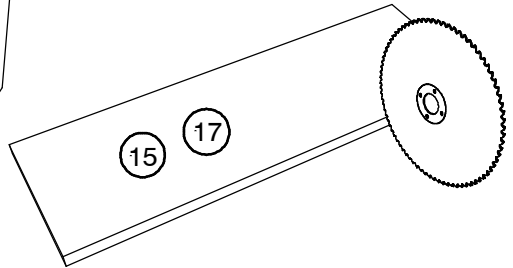
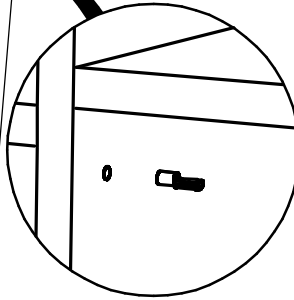
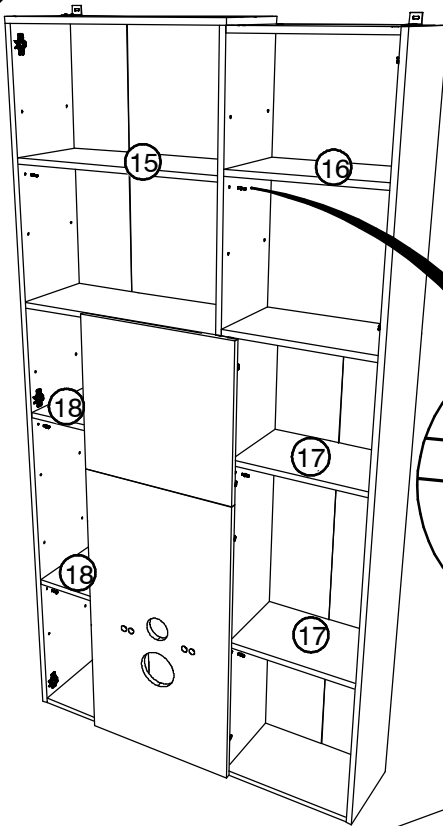

15

BWD x24



15 17 A recouper de 100 mm

15 17 A recouper de 200 mm

16

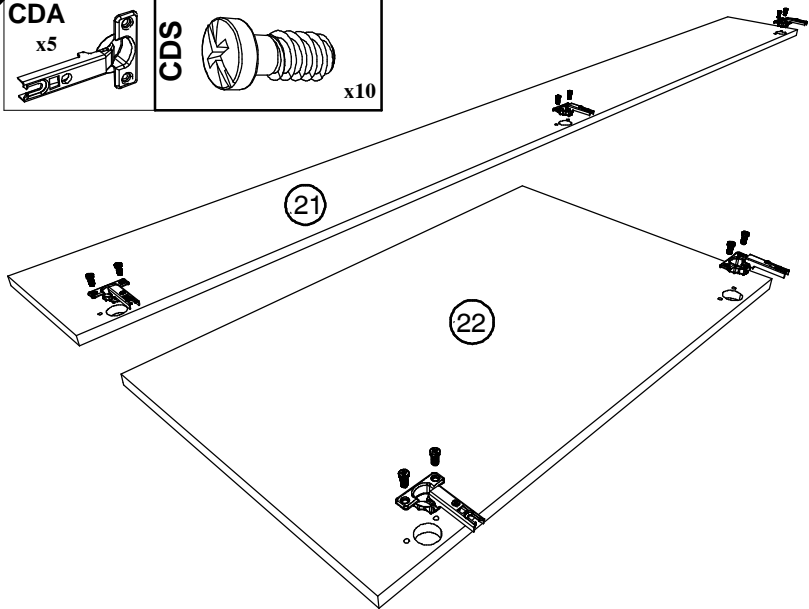
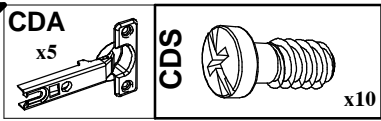

17

