

Info tri déchets

www.quefairedemesdechets.fr

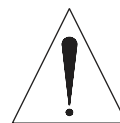

0H 35Mn



FR SECURITE
RESPECTER LES INSTRUCTIONS DE MONTAGE DECRITES DANS LA NOTICE.

EN CAUTION
FOLLOW CAREFULLY THE ASSEMBLING INSTRUCTIONS DESCRIBED IN THE DIRECTIONS.

DE SICHERHEITSVORSCHRIFTEN
BEACHTEN SIE BITTE UNBEDINGT DIE ANGEGBENEN AUFBAUVORSCHRIFTEN.

ES SEGURIDAD
RESPECTAR LAS INSTRUCCIONES DE MONTAJE DESCRIBIDAS EN EL FOLLETO.

NL VEILIGHEID
DE IN DE GEBRUIKSAANWIJZING BESCHREVEN INSTRUCTIES RESPECTEREN.

IT SICUREZZA
RISPETTARE LE INSTRUZIONI DI MONTAGGIO DESCRITTE NEEL'AVVERTENZA.

PT SEGURANCA
RESPEITAR AS INSTURAÇOS DE MONTAGEM DESCREVEDAS NA INSTRUÇÕES DE USO.

PL UWAGA
PROSZĘ PRZESTRZEGAĆ INSTRUKCJI MONTAŻU.

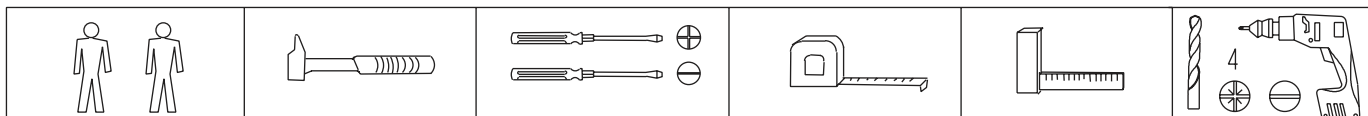

REP	DIM	QTE
1	2030 x 396	1
2	2030 x 396	1
3	366 x 395	1
4	366 x 395	1
5	366 x 395	1
6	366 x 395	3

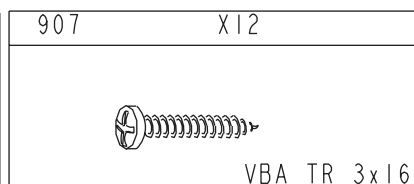
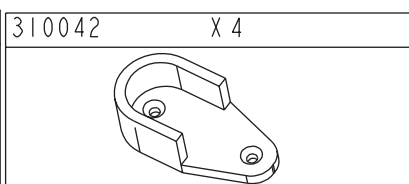
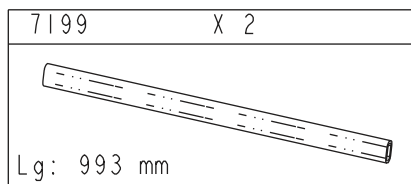
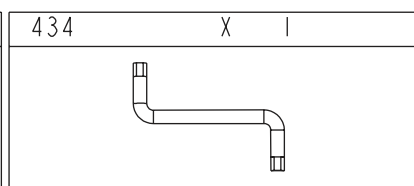
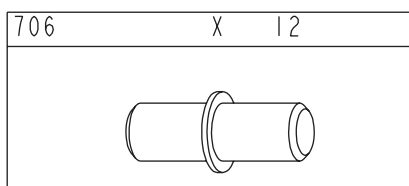
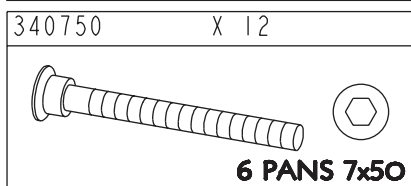
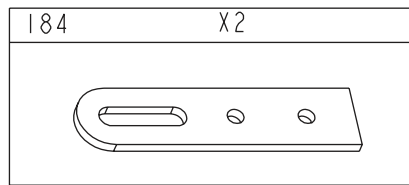
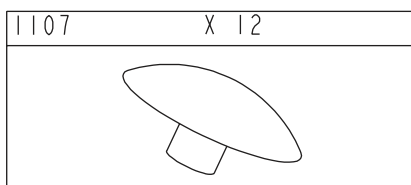
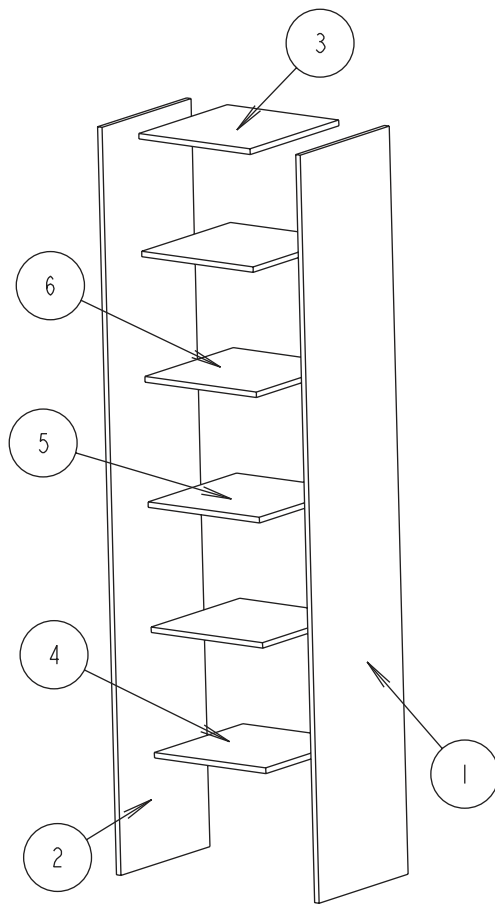

0

10

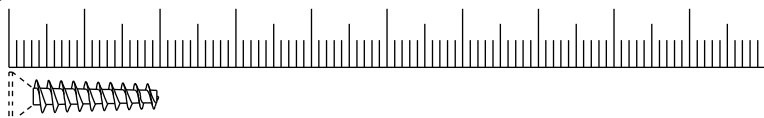

FR

AVERTISSEMENT : MEUBLE A FIXER IMPERATIVEMENT AU MUR AFIN D'EVITER SON BASCULEMENT

- Pour installer correctement ce produit et éliminer les risques pour votre sécurité, merci de suivre exactement ce manuel d'instruction.
- Fixer le meuble au mur avec les attaches prévues à cet effet
- Les vis et les chevilles ne sont pas fournies. Utiliser des vis et des chevilles adaptées au support.

EN

WARNING: FURNITURE TO BE ATTACHED TO THE WALL TO PREVENT OVERTURNING

- Installation shall be carried out exactly according to those instructions-otherwise a safety risk can occur if incorrectly installed;
- Attach the furniture to the wall with the fastening provided for this purpose
- Screw and Pegs are not supplied. Use Screws and pegs adapted to the support.

DE

WARNUNG: DAS MÖBEL MUSS AN DER WAND BEFESTIGT WERDEN, UM ZU VERHINDEN DASS ES KIPPT

- Um das Produkt korrekt zu installieren und um Risiken für Ihre Sicherheit zu verhindern, die Gebrauchsanleitung genauestens befolgen.
- Das Möbel mit den vorgesehenen Befestigungen an einer Wand befestigen.
- Schrauben und Dübel sind nicht im Lieferumfang enthalten. Passende Schrauben und Dübel verwenden.

ES

ADVERTENCIA: ESTE MUEBLE DEBE ESTAR SIEMPRE FIJO EN LA PARED PARA EVITAR QUE VUELQUE

- Para instalar correctamente este producto y eliminar los riesgos para la seguridad, seguir exactamente las instrucciones del manual.
- Fijar el mueble a la pared con las sujeciones previstas a este efecto.
- Los tornillos y los tacos no están incluidos. Utilizar tornillos y tacos adaptados al soporte.

NL

WAARSCHUWING: MEUBEL MOET VERPLICHT AAN DE MUUR BEVESTIGD WORDEN ZODAT HET NIET KAN OMVALLEN

- Om dit product correct te installeren en alle risico's voor uw veiligheid te elimineren, gelieve de instructies in deze handleiding nauwgezet op te volgen.
- Zet het meubel vast aan de muur met de hiertoe voorziene bevestigingen.
- De schroeven en pluggen zijn niet meegeleverd. Gebruik schroeven en pluggen die geschikt zijn voor het materiaal van de muur.

IT

AVVERTENZA: MOBILE DA FISSARE IMPERATIVAMENTE AL MURO PER EVITARE CHE SI RIBALTI

- Per installare correttamente questo prodotto ed eliminare i rischi per la vostra sicurezza, si prega di seguire esattamente il manuale d'istruzioni.
- Fissare il mobile al muro con gli appositi ganci.
- Le viti e i tasselli non sono forniti. Utilizzare viti e tasselli adatti al supporto.

PT

ADVERTÊNCIA: MÓVEL A FIXAR OBRIGATORIAMENTE À PAREDE PARA EVITAR A SUA QUEDA

- Para instalar corretamente este produto e eliminar os riscos para a sua segurança, é favor seguir exatamente este manual de instruções.
- Fixe o móvel à parede com as fixações previstas para o efeito
- Os parafusos e as cavilhas não são fornecidos. Utilize parafusos e cavilhas adaptados ao suporte.

PL

OSTRZEŻENIE: MEBEL NALEŻY PRZYMOCOWAĆ DO ŚCIANY, ABY UNIKNĄĆ JEGO PRZEWRÓCENIA

- Aby prawidłowo zainstalować ten produkt i wyeliminować zagrożenie dla bezpieczeństwa użytkownika, należy postępować zgodnie z niniejszą instrukcją.
- Przymocować mebel do ściany za pomocą mocowań przewidzianych w tym celu.
- Śruby i nakrętki nie znajdują się w zestawie. Użyć śrub i nakrętek dostosowanych do wspornika.

CR

UPOZORENJE : UČVRSTITE ORMARIĆ NA ZID KAKO BISTE SPRIJEČILI NJEGOVO LJULJANJE

- Kako biste pravilno postavili ovaj proizvod i uklonili sigurnosne rizike kojima se izlažete, pridržavajte se strogo ovog priručnika s uputama.
- Postavite ormarić na zid pripadajućim sponama.Vijci i svornjci ne isporučuju se. Upotrijebite nosne vijke i svornjke.

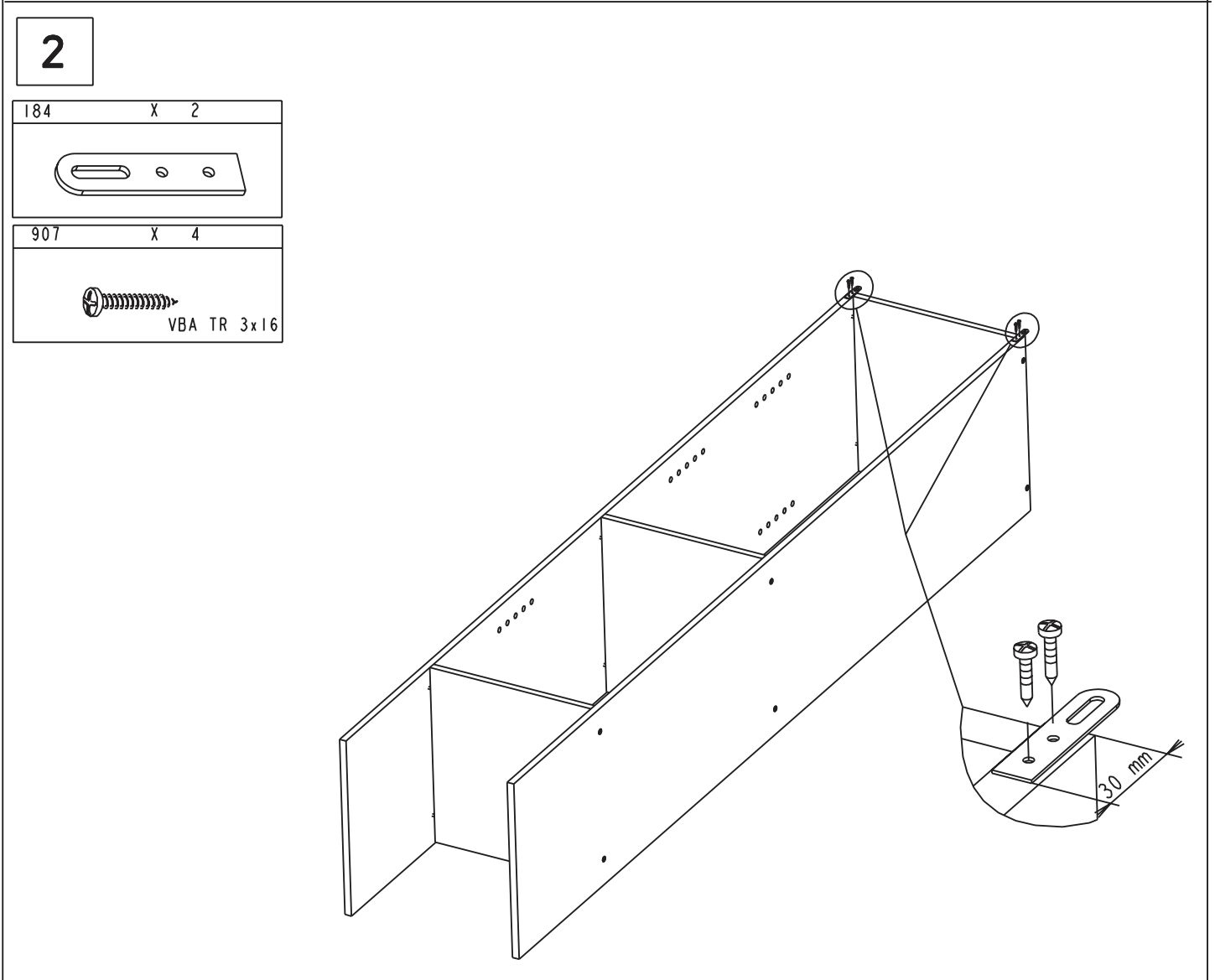
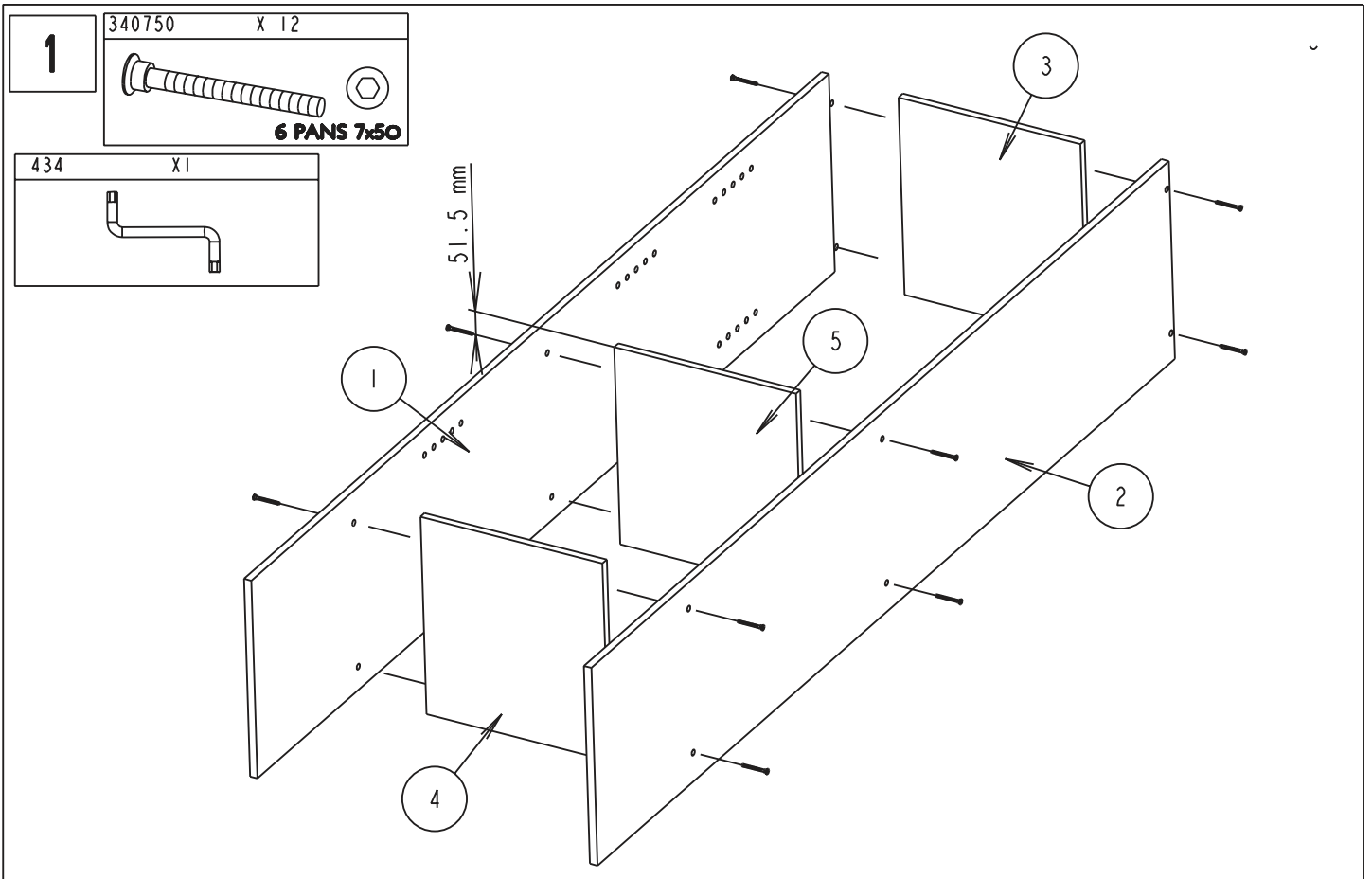

3

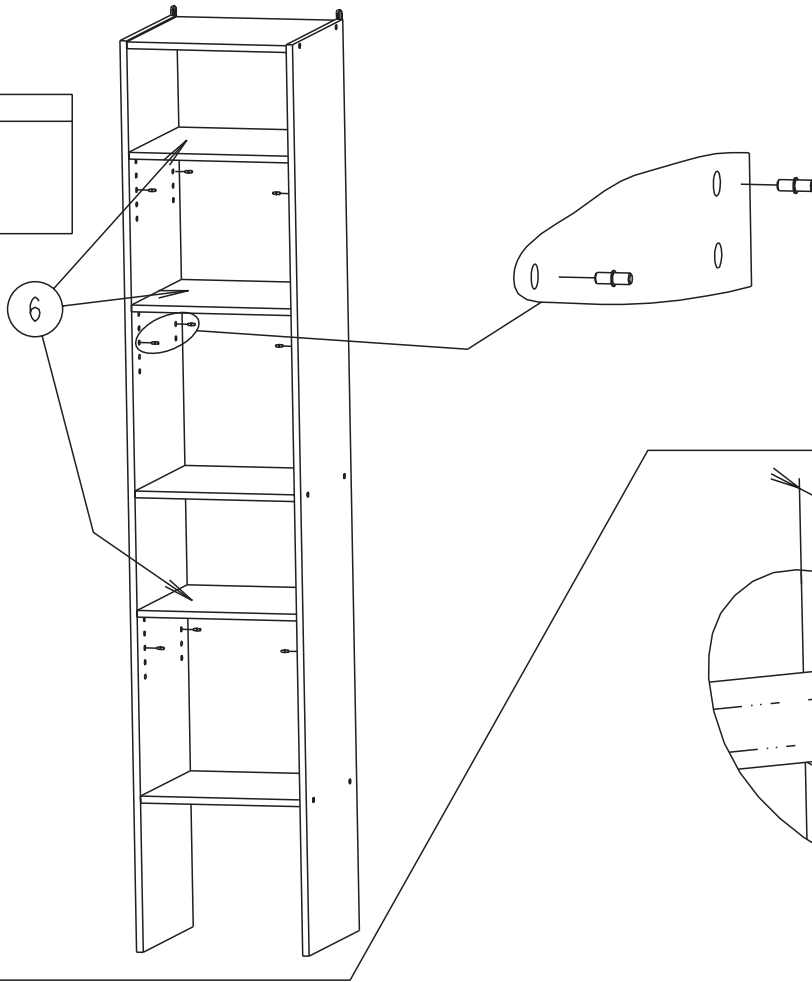
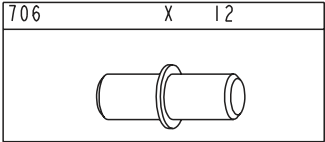

4

